

Weather
Winds Diminishing

Times-News

Final Edition

The Magic Valley Newspaper Dedicated to Serving and Promoting the Growth of Nine Irrigated Idaho Counties

TWIN FALLS, IDAHO, WEDNESDAY, APRIL 17, 1968

VOL. 65, NO. 2

TEN CENTS

CSI Duns Counties For Delinquent Fees

By RUTH KOONCE MILLER
Times-News Staff Writer

College of Southern Idaho trustees have taken an attempt in advising area counties that the college is not in a position to "operate on a credit basis" and have insisted that tuition bills from the various counties be kept current.

Students from counties which are delinquent in their tuition payments will be required to personally pay the full non-resident tuition upon enrollment.

Which revert from the state back to the counties, and up to a three-month period. Of the two counties whose payments are still delinquent for the second semester, one owes only \$1,150. This amount has not been paid, apparently because of a misunderstanding in the interpretation of the law.

That county maintains that some of the students who enrolled in CSI from that county dropped out, however, the tuition does not have to be paid. However, the students dropped out after the last day for withdrawing with a refund.

It also was pointed out that these delinquencies are for this semester. Each area county was billed Feb. 15 and was expected to make payments by the meeting of their respective county commissioners.



NEW CSI ACADEMIC DEAN Dr. Terry Smith, left, discusses his appointment with CSI president Dr. James L. Taylor. Dr. Smith, who is currently completing doctoral requirements at the University of Texas, will report for work by June 1. His appointment was confirmed during a Tuesday night trustee meeting.



CSI Board Approves New Dean, Revenue Bond Picture Gloomy

College of Southern Idaho trustees Tuesday night approved a new academic dean and a revenue bond picture gloomy. The city's \$200 per acre bond issue for construction at this time, and in other areas, was also approved.

Johnson And Park Hold Conference In Honolulu

By FRANK CORMIER

HONOLULU (AP) - Issues of international relations in the potential Korean powderkeck, occupied President Johnson and the wretched Park, then Chung Ilge Park of South Korea today for a one-day conference.

cheering crowd that pressed against the fence. The Korean leader, attired in a white suit, was greeted by Johnson to greet the crowd, then climbed into a helicopter to be whisked to his hotel.

industrialist Henry J. Kaiser. Park's visit coincided with important developments affecting his country and the military-diplomatic situation in Vietnam.

line between North and South may have been deliberately disrupted by the Park meetings.

war may need to be held in summit conference in advance of any substantive peace talks with Hanoi. American officials said it would be premature to consider such a move in the absence of any firm indication that such talks will take place.

Memphis Sanitation Men Back To Work

MEMPHIS, Tenn. (AP) - The city's 1,200 sanitation collectors returned to their jobs early today, after settlement of a labor dispute which brought Dr. Martin Luther King Jr. to the city, where he was killed.

Patterson declared, "And then a majority of the council changed their mind... refused to take any action on this matter and a lot of hell broke out across the city."

Decision Delayed One Year On Regional Airport Site

Members of the Southern Idaho Regional Airport Board announced Wednesday that any decision on a site for a regional airport will be delayed for a year.

Two sites have been under consideration, one north of the Perrine Memorial Bridge and one north of the Hanes Bridge. The FAA is still making cost studies on both sites and has indicated both would be acceptable as a regional airport.

Nuclear Blast Set For April 24

The Atomic Energy Commission said Tuesday the blast would be left up to 250 miles away but would be contained in a 3,900-foot-deep crater. The regional district will be confined below the surface, the AEC said.

Members of the Southern Idaho Regional Airport Board announced Wednesday that any decision on a site for a regional airport will be delayed for a year.

Magic Valley Finds Trace Of Winter

A trace of wet snow which whitened lawns and shrubs across Magic Valley Wednesday morning served to remind residents that summer is not here yet.

The trace of snow was reported in the Magic Valley area for the first time since the snow melt in March. The snow was seen on a hillside near the town of Ketchum, there still is one-quarter of an inch on the ground. It snowed heavily for a short time Tuesday to record a 2.4 inch of snow with a water equivalent of .31. This is the least amount which can be registered.

Recipes

Additional copies of your Favorite Recipes, the 1968 edition of the Magic Valley Cook Book, are available at the Times-News office.

North Vietnamese Resume Shelling Of Khe Sanh

By EDWIN Q. WHITE
SALGEM (AP) - North Vietnamese resumed shelling of Khe Sanh with the heaviest of the worst days of the U.S. Marine bastion's 77-day siege.

The casualties were the heaviest in two weeks at the combat base, official sources said. The North Vietnamese mounted a 200-round attack by artillery, mortars and 100-pound bombs.

small-arms fire. U.S. fighter bombers and artillery pounded the enemy's attack units. North Vietnamese escaped about midnight.

Goldberg And Thant View Talk Sites

UNITED NATIONS, N.Y. (AP) - A U.N. spokesman said today Secretary-General U Thant and U.S. Ambassador General Henry Kissinger suggested that Thant and U.S. officials discuss possible sites which are likely to be acceptable to both Washington and Hanoi.

School Lunch Program To Be Extended

WASHINGTON (AP) - The Senate voted 84-14 today to extend the popular school lunch program in day care centers and in school recreational facilities, especially in summer.

Five Inmates Killed In Prison Protest

RALEIGH, N.C. (AP) - Guards opened fire on 500 demonstrating inmates at North Carolina Central Prison today, killing five and injuring 75. Five prisoners also were injured.

They began throwing lighted objects on the unarmed custodial officers, and the armed custodial officers began opening fire.

Twenty-five men of a South Vietnamese airborne battalion were wounded in a battle seven miles north of Saigon.

Taxi Driver Identifies FBI Sketch

ATLANTA, Ga. (AP) - A taxi driver here today identified a sketch of a man who rode with him two blocks in northeast Atlanta's "hippie" section last night after Dr. Martin Luther King Jr. was slain.

Phone Strike Said Almost Certain

WASHINGTON (AP) - President Joseph A. Beirne of the CIO Communications Workers of America today threatened a nationwide strike Thursday.

Traffic Deaths

Idaho
1968..... 69
1967..... 60
Magic Valley
1968..... 7
1967..... 10

London Bridge Falls Down, Americans Picking Up Pieces

By GRANVILLE WATTS
LONDON (AP) - London Bridge is finally falling down, and the Americans are picking up the pieces.

Samuelson Will Return Friday

BOISE (AP) - Gov. Don W. Samuelson conducts Thursday's visit to Japan, then he has been attempting to promote exports to Japan.

Charges Denied

TOKYO (AP) - North Korea denied today U.S. charges it was responsible for an ambush which killed two American and two South Korean soldiers near the Panmunjom truce village Sunday.

Phone Strike Said Almost Certain

WASHINGTON (AP) - President Joseph A. Beirne of the CIO Communications Workers of America today threatened a nationwide strike Thursday.

Traffic Deaths

Idaho
1968..... 69
1967..... 60
Magic Valley
1968..... 7
1967..... 10

London Bridge Falls Down, Americans Picking Up Pieces

By GRANVILLE WATTS
LONDON (AP) - London Bridge is finally falling down, and the Americans are picking up the pieces.

Samuelson Will Return Friday

BOISE (AP) - Gov. Don W. Samuelson conducts Thursday's visit to Japan, then he has been attempting to promote exports to Japan.

Gives Up Role

MARTIN BRANDO said Tuesday he is giving up the starring role in the film "The Arrangement" in the role of a turkey FBI agent.



SOMETHING NEW is being added to the summer rodeo season in Twin Falls this year. A statewide clinic will be held June 8 and 9 to assist novice contestants in the finer points of winning queen titles. Accepting initial entries during a planning meeting in Twin Falls are Karen Jones, Twin Falls

co-chairman of the event; Donna Willis, Eden; Melody Brown, Kimberly; Lana Brackenbury, Jerome, and Karen James, Jerome, all from left. Mrs. James, a former Miss Rodeo America, is one of several experts selected to instruct girls in appearance, personality and horsemanship matters.

Cowgirls To Get Expert Advice

Rodeo Queen Clinic Set Here

Tricks for catching the judges' eyes and gaining points toward rodeo queen crowns will be discussed in Twin Falls June 8 and 9 during the second annual Idaho Rodeo Queen Association clinic. The clinic is directed by co-chairman of the event, Donna Willis, Eden; Melody Brown, Kimberly; Lana Brackenbury, Jerome, and Karen James, Jerome, all from left. Mrs. James, a former Miss Rodeo America, is one of several experts selected to instruct girls in appearance, personality and horsemanship matters.

On Sunday the group will move to Frontier Field where Mr. McCallie, Mrs. Jones and others will conduct the horsemanship sessions. Opening the Sunday program will be a church service on horseback at the field. Bud Goddard, Gooding, will conduct services. Mrs. Jones said women who may not be planning to enter queen contests but who serve as judges or who work with girls in such contests also may clinic directors to reach every-

Zap Missile Being Made By Navy

By DON HORTON,
AP Military Writer
WASHINGTON (AP) — The Navy is moving swiftly toward production of a new weapon nicknamed the Zap missile. To bolster U.S. capabilities for beating down North Vietnamese antiaircraft guns. The Zap is an acronym for zero antiaircraft potential. Details of the missile's planned capabilities are closely guarded but work is far enough along that officials are being allowed to discuss generally its mission. The Zap, sources said, will be a solid-fueled "hypervelocity" rocket that will fly at speeds around 2,600 miles per hour and detonate with shattering effect over enemy fire sites. Within two years the missile is expected to go aboard Navy fighter-bombers and may also be used by the Air Force. Industry expectations are that production of the Zap will soar to several hundred thousand per year by about 1972 with annual spending of about \$50 million. "We will be the first to plaster the ground with this thing," one officer said. Zap will have a conventional explosive warhead of unspecified size designed to go off just before it hits the ground with a special high-fragmentation effect. The weapon's fantastic speed is critical to the mission. With Zap the pilot of a 1,400-m.p.h. Phantom jet, for example, will be able to launch his weapon almost point-blank at an enemy target while zooming at supersonic speed. "What that ensures called the missile's "instantaneous acceleration" there will be no danger the pilot might overtake his own weapon in flight. Instances of planes being shot down by their own missiles have occurred.

At the same time, with Zap's new discerning warhead the pilot won't have to be too concerned with precise targeting. Looking at it from the standpoint of a Navy pilot assigned to knock out an antiaircraft site in advance of a bombing raid, the officer explained: "I'll be beating down the flak not only for the boys behind you, but for yourself."

TEACHERS NEEDED
RICHFIELD — Niel Anderson, acting superintendent for Richfield schools, stated Tuesday that teachers were still needed for social studies, 11-hour, second and seventh grades.

Lowmovers — New and Used. Small items — Small items — Small items. **POWER BAKES FOR RENT.** PICK UP & DELIVERY. **INTERMOUNTAIN** INC. 733-6621 — Twin Falls



your **Idaho** store
TWIN FALLS
SPORTSWEAR — 2nd FLOOR

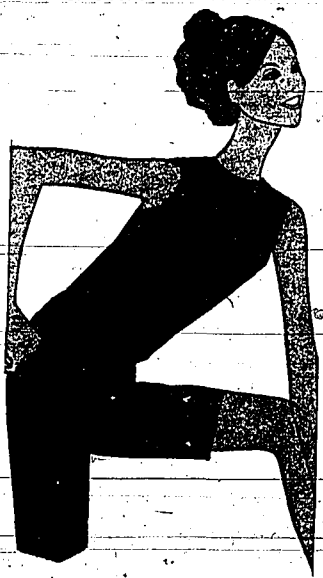

Two Join Real Estate Company
Mrs. Elmer Sommer and Dwight Shaw have recently joined the Shaw Realty sales force, according to Mrs. Dwight (Susan) Shaw, broker. Mrs. Sommer's husband, Elmer, is also employed at Shaw Realty, and Mrs. Shaw's husband just recently took the state board examination and joined the firm. Jack Witherspoon is also a salesman for the firm at 1230 Addison Ave. E.

Let the Profile Bread Plan help your Slender Years.

your **Idaho** store **OPEN FRIDAY NIGHT 'TIL 9 P.M.**

WEEK-END SPECIALS

- ★ READY TO WEAR ★**
 - WOMEN'S KNIT SUITS \$22.00 (Comp. at \$40.00)
 - BETTER KNIT SUITS AND DRESSES 1/2 PRICE
 - WOMEN'S EARLY SPRING DRESSES 1/2 OFF
 - SPRING COATS, Sizes 8-18, Various, 1/2 OFF
- ★ FABRICS ★**
 - FABRICS: Gabi print in a beautiful array of colors, Regular \$1.50 NOW .99¢
 - BONDED KNITS, A very nice selection of spring colors, Regular \$4.99 \$2.99
- ★ LINENS ★**
 - CURTAINS, Ideal to brighten your kitchen, 26 inch length, Regular \$3.98 .99
 - BEDSPREADS, Famous name first quality, floral and plains, \$14.99

- ★ SPORTS WEAR ★**
 - WOMEN'S BLOUSES, Group 1, Perma press cottons and blends, Sizes 22-40, Regular \$3 NOW \$1.99
 - BETTER BLOUSES AND SHIRTS \$2.99
 - LADIES' PANTS, Group knits, Sizes 8-20, (Some extra sizes) Regular \$4-\$7 NOW \$2.99
 - BULKY CARDIGAN SWEATERS, One group, 100% acrylic, Sizes small, medium, large, White, beige, orange green, green, yellow, pink, Blue, Reg. \$8.50 NOW \$5.99
 - WOMEN'S LIGHT WEIGHT CARDIGAN SWEATERS, 100% acrylic, Sizes 28-46, Regular \$6 NOW \$3.99
- ★ MEN'S - BOYS' ★**
 - MEN'S SUITS, Assorted colors and broken sizes, First quality, Regulars and long, Most sizes are available, 1/2 PRICE
 - MEN'S HOPSACK PANTS, Famous name, Good colors plus pure white, Sizes 28 to 38, If perfect, \$9, NOW ONLY \$4.77
 - MEN'S DRESS SHIRTS, Famous name shirts in broken sizes, All long sleeve, White and some colored, Discontinued numbers, Regular \$6.00 \$3.99
 - MEN'S SPORT SHIRTS, Assorted short sleeve, regular and button down collars, Flare and patterns, Values compare to \$6.00, \$3.10
 - MEN'S CASUAL AND DRESS SOX, Assortment includes stretch sizes 10 to 13, Reg. \$1.50 values, NOW 3 PR. \$2.88 — 6 PR. \$5.50 .99¢
 - BOYS' HOPSACK JEANS, Famous name brands, Good color assortment, Reg. \$6 and \$8, If perfect, NOW \$3.77, \$4.77
 - STRETCH JEANS, Boy and Girl sizes, Discontinued colors, Sizes 4-12 in regular and slim, 26 waist to 34, Regular \$4.98 and \$6.98 \$2.99

- ★ GIRLS' DEPARTMENT ★**
 - GIRLS' DRESSES, COSTUMES, COATS 1/2 OFF
 - GIRLS' SPRING/SUMMER SLEEPWEAR, One Group \$2.99

- ★ SHOES ★**
 - WOMEN'S CANVAS SHOES \$2.97
 - GIRLS' FLATS AND CASUAL SHOES \$5.44

your **Idaho** store
TWIN FALLS
SPORTSWEAR — 2nd FLOOR

Summer Pace-Setters
just wear a smile and a janizen

SHOP DAILY 9:30 to 5:30
FRIDAY 9:30 to 9:00
Idaho Dept. Store

A. LEFT
Tops on your checklist: Janitren Sun Sheen Checks, tailored for occasion and made to match many solid color separates. 50% Dacron® polyester, 50% cotton with JonPress® finish — to wash, wear and never iron, even Tiger pink or heavenly blue, sizes 8-18. Sun Sheen Check bermuda with white stretch straw belt, \$9. Button down shirt, \$6.

B. BELOW
Cool as a big dish of ice cream: Janitren Basketweave, in many beautiful ports. When the thermometer soars and the sun sizzles, slip into a cool little shell rounded off with lace and a comfortable, jamica. They're fashioned of geometric-textured cotton, in tiger pink, lemon twist, or heavenly blue fringed with white. Basketweave jamica, sizes 8-16, \$7. Basketweave shell, S-M-L, \$6.

C. ABOVE
This is the lack of summer: Cobblestitch coordinates, new for you from Janitren in many wonderful parts. Crunchy with texture interest. Bonded to keep its shape and feel silky next to your skin. Sizes 8 to 18 in tiger pink, lemon twist, heavenly blue, white. (Machine washable 100% cotton laminated to 100% acetate tricot) Cobblestitch, shell, \$5. Cobblestitch-jamica, \$7.

Editorial Page

PHNCE 733-0931
Member of Audit Bureau of Circulation and AP
Published by JACK MURPHY
Editor: O. J. SMITH
Managing Editor: PAUL STANFIELD
Business Manager: WILEY DODDS

Negro's Best Path

The latest orgy of rioting in America's cities accomplished as much for either the short-term or long-term welfare of their inhabitants as did the Viet Cong's assaults against the cities of South Vietnam. And that is nil.
For just as the Tet offensive failed to set off a popular uprising that would overthrow the Saigon government, kick out the Americans and pave the way for a Hanoi-dictated peace...

The likes of Stokely Carmichael capitalizes on this tragedy to further his gospels of hate, and while some whites used the ensuing riots as justification for continued racial segregation, many other Americans found a deeper, truer meaning in King's martyrdom.
At memorial services in Cleveland, a white man approached a Negro. "You don't know me," he said, "but I'd like to stand beside you." They did stand together, arm linked in arm, throughout the program.
This may not mean much. The two men went their separate ways, the one to his wife's job, his white friends, his white neighborhood, the other to his black counterparts. They probably will never meet again.

MR. SPECTATOR

A Prayer For Peace

A Young Navy officer has written a Prayer For Peace. A column reader a woman who reads this falls in love with it.
We think it is worth the consideration of people who read this column. We will honor the request of the sender and not use her name.
But here is the U.S. Navy officer's prayer:
This is my prayer for peace.
We pray, God, not for the easy life with that at our finger tips, but for the hard life with love in our outstretched hands.
We pray, God, not for a cessation of battle or bombing, but for the cessation of the need for war. This is our prayer for peace.
We pray, God, not for the removal of the atomic weapons of life, but for the ability to handle them as they arise.
We pray, not for an end of the discomfort of responsibility, and burdens, but for the ability to assume even more responsibility.
This is our prayer for peace.
We pray, not for order in our cities but for the order in our lives to extend to our cities. We pray, not for an end to teenage freedom, but for the continuation of teenage individuality.
This is our prayer for peace.
To know the peace of stars and Mars and showers and flowers.
We assume that our babies and Mother's ays and Father's ays.
To know the peace of girls and pearls and toys and games.
Democracy and rolling sea and waving flags and healthy legs.
We pray, God, not for an easy peace but for one that is not for a complete peace but for a workable one—not for an enriching peace but for an enlightened one.
We pray, God, not for a world of pieces but for a world of Peace, Amen.

PUEBLO PUZZLE
So much effort
And conversation;
Complete frustration.
\$25-50
COMPLIMENT
Mr. Spectator got a note from Wills Putnam, who was captain of the Golob Oil bowling team from Pucetello. The members spent some time with the team in connection with the big tournament.
And she was all thrilled with the treatment received during the stay here. But let's read the letter:
" This is just a note to tell you how much we appreciated your kindness during the recent visit of our bowling team to your city. Though all our bowling years have never been treated better.
"A special thanks goes to your Chevy garage where a man by the name of Roy McGuire stayed overnight to fix my car. Thank you again, Roy.
" And to all the people at the Griggs Motel that were so kind to have us here to come to your city again real soon."

WASHINGTON — One of the main reasons why the New Breed of political police administrators seems to regard us merely as a job, is that they are not interested in the nation's capital as that every bleeder who can be pricked out of the woodwork is found there to occupying the Pentagon.
For example, the city's new manpower training center — a job, Corps outfit transferred from Nebraska — was hurriedly opened one week ahead of schedule, and politicians of the Bobby Kennedy kind are demanding the spending of new billions to educate and employ the more underprivileged Negroes.
This upsurge reeks with irony when studied alongside a survey made by the Washington Post of the first 110 persons arrested for looting here. The Post found that only 13 of these persons, or a mere 10 per cent, were unemployed, and that the typical suspect was 29 years old, had attended 11 grades of school, and had a job paying \$245 a week. More than half of them were married, a statistic that casts doubt on the argument that teenage hoodlums were the principal culprits.

An interviewer from the D. C. Bail Agency described most of the nearly 1000 persons arrested for looting as "an amazingly respectable crowd." It is curious indeed to apply to rioters, but it is also revealing. It is a far cry from the picture of the amateur sociologists that only despoil people loot stores and set fires.
The National Advisory Commission on Civil Disorders offered a profile of the rioter in the country last summer, as a young, single Negro male, 15 to 24, who dropped out of high school after one or two years.
Washington's looter bears little resemblance to the profile. The 110 studied included five Howard University students, a Virginia Seminary freshman, a three-year-old estate agent, a United Brotherhood Organization counselor, an apartment house manager, and an assistant librarian.
They included a 40-year-old assistant cook and church deacon and a 35-year-old government mechanic with five children. Most of the school dropouts were "runners" — 22 of the 26 arrested on April 21, only six had not finished high school. Twenty-seven others had attended college and two were college graduates.
Eleven of the suspects were members of the Federal Reserve, five of them for the Post Office, which is considered a "status" employer in the Negro community.

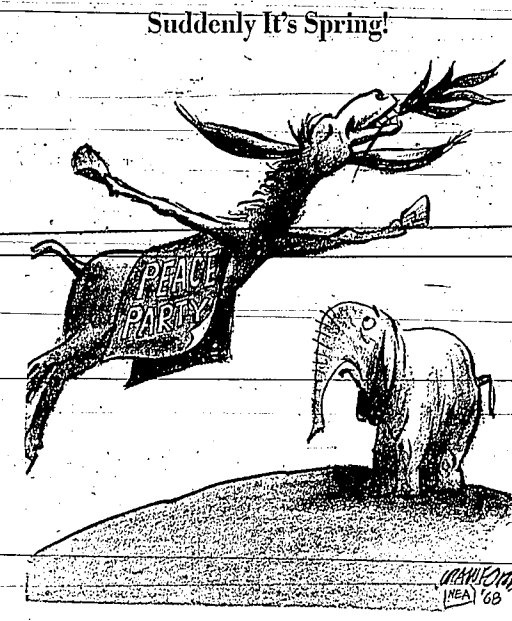

LEON DENNEN

Viet Cong Are Red Terrorists

NEW YORK — The Communists, as usual, will seek to gain at the negotiating table the victory that eluded them on the battlefield.
Their basic aim is to subvert and destroy the fragile Saigon regime. Their strategy, to take over South Vietnam by including the Viet Cong terrorists—the so-called National Liberation Front—in "revolutionary government."
Tragically, two leading Democratic contenders for the presidency, Sen. Eugene McCarthy and Sen. Robert F. Kennedy, went on record, supporting Ho Chi Minh's "solution."
In violation of all the rules of diplomacy, Kennedy, it seems, wants to make this crucial concession to the Communists' even before the real bargaining starts.
Kennedy sees the Viet Cong despite "his brutal acts of terrorism"—a "powerful force of Vietnamese nationalism." They must be granted a role in Vietnam's political life, he told crowds of cheering youngsters.

President Johnson also has made it clear that to achieve peace, he is prepared to negotiate with the Viet Cong, among others.
But the President will negotiate with the Communists because they are behind the student rioting and anti-

Russian agitation in Poland and Czechoslovakia.
Kennedy's view of the Viet Cong as nationalists is a sad reminder of the tragic debacle in 1949 and 1953.
In 1949, self-proclaimed liberals in the State Department regarded Mao Tse-tung as a nationalist and "agrarian reformer."
Top American diplomat was horrified when this writer spoke in Havana in 1959 that Fidel Castro was a Communist. "He was drawn in," the diplomat exclaimed. "He is a nationalist. He is the George Washington of Cuba."
Now it is Ho Chi Minh—a lifelong agent of the Red International, trained in Moscow, and the real boss of the Viet Cong—who is described by some liberals as the "George Washington of Vietnam."
To be sure, Communist propagandists, when it serves their purpose, seek to inflame and exploit the nationalist feelings in Asia, Africa and Latin America as a force against the free world.
They are also exploiting nationalism in the Middle East.
But surely men who aspire to high public office should know the difference between true nationalism and communism.

BRUCE BOSSART

McCarthy: A Rockier Road

WASHINGTON (NEA)—When Wisconsin winners Sen. Eugene McCarthy and his followers break off their celebrating their understandable state of euphoria, they will find that their New Hampshire showing may begin to diminish. The hard challenges are all ahead.
In a little more than a month, on May 7 in Indiana's presidential primary, McCarthy has his first head-to-head encounter with his late-starting rival, Sen. Robert F. Kennedy. Thereafter there follow a series of other contests in Nebraska, Oregon and California.
Indiana looks very tough for McCarthy, complicated for both him and Kennedy by the presence of a pro-administration state senator, Gov. Roger Branigan, originally a stand-in for President Johnson.
Oregon and Nebraska are farther prospects right now, but it is hard to tell whether the late primary states will accept both McCarthy and Kennedy.

The Californian's biggest concern seemed to be that logic had not been paying too much of a role in recent political events.
McCarthy's 57 per cent of the Wisconsin vote on the Democratic ticket was impressive, though President Kennedy's two days earlier had declared his intent not to run for reelection.
Some labor leaders had forecast an even bigger McCarthy edge. It is not clear whether the "nationalist" element were behind the state made too deep a dent in their thinking, or whether they were simply oversteering the outlook to salvage some face for Johnson, whom they were backing but not helping greatly.
Fundamentally, the Wisconsin outcome went according to the late book, since McCarthy's triumph was widely forecast. With Johnson's pull-out, there evidently were far fewer Republican crossover to McCarthy than had been expected.

Nixon ran up 29 per cent of the total GOP vote, identical with his New Hampshire showing. His closest rival was Gov. Ronald Reagan, of California, whose 11 per cent fell exactly within the 10 to 15 per cent range predicted for him by Nixon men.
They also hoped Nixon's total would be close to 35-40 per cent of the general primary total. It reached just 31 per cent, but that was three points better than had been expected.
The candidate who gets around 80 per cent of his party's vote even in virtually no-contest states is not faltering. Many Republican party leaders may still have doubts about Nixon's electability. But they cannot doubt his present high momentum.

JAMES MARLOW

The Deep Change

(Editor's Note: Mr. Marlow is this column's Associated Press writer.)
WASHINGTON (AP) — Down the mall from the bright huble of the Capitol dome to the brooding figure in the Lincoln Memorial, Washington looks the same. But a deep change has taken place.
A city that had been slowly hardening into two separate cities, one white and one Negro, has been made scarily aware of it. How it reacts to this awareness may hold an answer for other cities afflicted with racial troubles.
One answer is carefully planned response to looting and burning may be able to achieve results without the bloodshed and violence that marked last summer's riots in Newark and Detroit.
In the early stages of the disorders in the capital, the outnumbered police were without the bloodshed and violence that they would not have to resort to gunfire to protect themselves. They were forced merely by with restraint against the looters and to curb violators by fire hoses.
The result was a minimum of deaths and injuries—and a great deal of money. The reform of the District of Columbia police and the troops has been a far-reaching one. Ramsey Clark and it is likely to set a pattern for the police in other cities.
It was an encouraging sign in the immediate response of the white community to the despair the black community indicated in their ill-tempered reaction.

Wayne Brandstadt, M.D. Boiled Eggs. Q—is there any harm in eating eggs that have been removed from the shell and kept in the refrigerator? A—If the eggs were good to begin with and are not kept too long as to have spoiled, they can be eaten raw or cooked. If they have been cracked before you took the egg out of the carton there is danger of bacterial contamination and food poisoning. Refrigerator does not lessen this danger but through cooking (hard-boiling) will eliminate it. Q—My husband eats about six eggs a day. Is it safe and good for him to eat that many? A—Although eggs are an excellent food, their yolks have a high cholesterol content. Most doctors now advise eating three to six eggs a week. Q—What foods are permitted on a low cholesterol diet? A—A hand diet omits pepper, mustard, horseradish, vinegar, citrus and sweeteners. It also omits, but it should contain a minimum of roughage—a raw fruit or vegetable. A diet with a small amount of pure vegetable or fruit is sometimes allowed. A reducing diet omits most but not all of what's left. That excludes alcohol, especially beer and other products that give 25 calories per serving and still supply all the nutrients. Q—is it beneficial or harmful to take a little nap after a meal? Could it cause obesity? A—Yes, a nap after the noon or evening meal is an excellent restorative for both muscle and mind. Obesity will not be caused by a nap after a meal. Obesity will be caused by the food you eat. Q—What foods should be avoided to reduce cholesterol? A—The acidity of any food in your body depends on its ash or residue when it is fully consumed. Foods of any kind help to alkalize your system. The foods to avoid are meats (except crabmeats), cherries and rhubarb in spite of the fact that they contain a weak acid and have a low residue. Other foods to avoid are, you should cut down on, but not eliminate from your diet, are butter, salt, meat, corn, peanuts and sweets.

Report Given On Fire

BURLEY — City Councilmen heard a complete report on water supply and discussed the recent fire at Overland Shopping Center, Monday evening during a meeting at the city hall.

"There was no water shortage during the recent fire," Mayor Joe Peters reported. "The seven fire trucks which were hoisted directly to the water lines were never out of water," he added.

"Water department men were stationed at the pumps and one of the pumps had to be turned off and then back on several times due to the water tank running over," he stated.

"The auxiliary unit at Hogan Well was started and warmed up ready to be put into service in case the electricity went off. However, the auxiliary unit did not have to be used. There were additional wells which could have been turned on if they were needed for additional water," the mayor said.

"I hope this clears up the rumor on the water situation during the recent fire," he added.

The Idaho Rating Fire Bureau, Boise, officials were in Burley following the Overland Shopping Center fire and reported to Oils Williams, fire chief, that with the water system in Burley the area-northern No. 6 could be rated between 4 and 5 for insurance rates.

In the last two years, seven and one half miles of water pipe have been laid to upgrade the water system, and 18 fire hydrants have been installed, and many small lines have been replaced with larger lines. This gives almost a complete circulation water system where water can be drawn from another area of town if needed, it was reported.

Special thanks were extended to the fire department, and to firemen from neighboring towns for assisting at the huge Overland Shopping fire.

Burley has six full-time firemen plus the fire chief, and the rest of the firemen are volunteers.

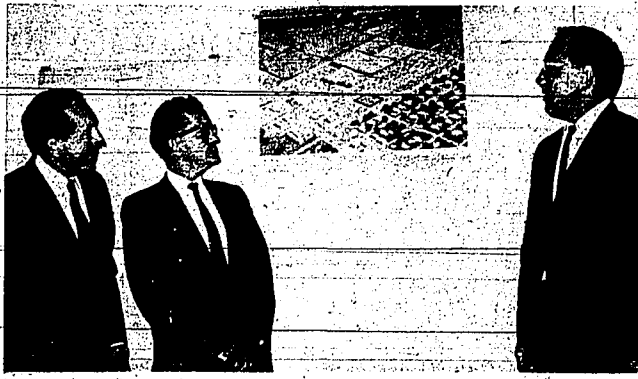

ATTENDING A luncheon Tuesday at the Ponderosa Inn, Burley, at which plans for a new \$3 million shopping center were announced, are, from left, John W. Nelson, president of Daum Development Corp., Nampa, which will build the air conditioned shopping center on the east side of town; E. L. (Bud) Elwell, Salt Lake City, president of Skaggs Food and Drug Center, Inc., and Floyd Weck, manager of the J. C. Penney store in Burley, Utah.

Skaggs and Penney's have announced plans to lease space for stores in the new center. Robert Saxvik, Chamber of Commerce president, and Mayor Joe Peters welcomed the officials to the luncheon attended by city and county officials as well as local businessmen. Edwin H. Law, president of Law Construction Co., Wichita, Kan., announced local labor will be hired and sub-contracts let to local firms for construction of the new facility.

News Of Record

MINDOKA COUNTY

Clerk's Office
Marriage licenses were issued to Darrell W. Memmott, Salt Lake City, and Patricia Ann Kerbo, Rupert, and to Steve Anderson and Ora Lee Chanlor, both Rupert.

Police Court
James F. Cook, 22, Rupert, 33, citations registered.

Sheriff's Blotter
No citations were issued Sunday when Jay M. Greer, 34, Rupert, rolled a 1952 Dodge pickup truck into the borrowpit a mile north of Acequia on 200 East. Greer told officers he wasn't familiar with the road and went into a curve a little too

fast, causing the accident. Damage to the pickup truck was estimated at \$300.

A cement truck belonging to Bishop Reddy Mils, Rupert, was demolished Monday when it ran off the roadway and struck a concrete siphon belonging to the Mindoka Irrigation District, about six miles northwest of Rupert.

Driver of the truck was Charley O. Clark Jr., 19, Rupert. He told officers he was looking across a field when the accident occurred.

The city's two week cleanup started Monday and all the buildings are urged to clean up their property of weeds.

MEMBERS EXPECTED 124th soon. Favorable Security [Twinn-Falls Times-News] 5
UNITED NATIONS, N.Y. [Council action is expected at a meeting Thursday on the appli April 17-18, 1968
(AP) — The United Nations, which started with 51 members of Mauritius, a former Ocean with a population of less than 1 million, in 1945, expects to welcome 149 British colony in mid-Indian then half a million.

66 PROOF - BLENDED WHISKEY - 65% GRAIN NEUTRAL SPIRITS © 1968 CALVERT DIST. CO. LOUISVILLE, KY.

It pussyfoots.

Calvert Extra, The Soft Whiskey, steals softly down. But as it purrs, remember: it's 86 proof.



TRIALS COMPLETED
QUINCY, Mass. (AP) — The USS Whale, the Navy's 75th atomic-powered submarine, completed her first sea trials Tuesday, the Navy announced.

Worly of FALSE TEETH
Slipping or Irritating?

Don't be embarrassed by loose false teeth slipping, dropping or wobbling when you eat, talk or laugh. Just sprinkle a little PASTAZOL on your plates. This pleasant powder gives a remarkable sense of added comfort and security by holding plates more firmly. No tummy, goopy, nasty taste. Dentures that fit are essential to health. See your dentist regularly. Get PASTAZOL at all drug counters.

People who save have one thing in common...



money!

Unless you set up a regular savings program and stick with it, you seldom have money when you need it — for a business investment, down payment on a new home, retirement income — or any other worthwhile goal. You can open a high-earning insured Passbook Savings account at First Federal in just a few minutes — why not do it today?

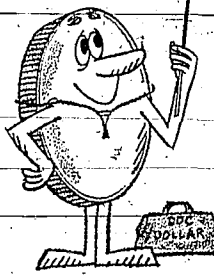

SAVING helps you LIVE BETTER!

Saving helps you live better!

4 3/4% COMPOUNDED TWICE A YEAR
CURRENT RATE
FIRST FEDERAL BANK

PRICE BUSTERS

STRETCH YOUR BUDGET WITH SPECIAL VALUES

Newberrys

IF IT'S QUALITY YOU'RE LOOKING FOR

24" MOTORIZED PORTABLE HOODED GRILL

Rolls anywhere on big 5 1/2" plastic wheels... has U.L. approved motorized hood, chrome plated spin and timer, 4 tubular steel legs. Grid positioner, Avocado.

Reg. \$12.95
NOW \$8.95

ELECTRIC FIRE LIGHTER

Starts fires speedily and safely... just plug in and kindle. U.L. approved.

REG. \$1.99
NOW \$1.27

HIBACHI WITH ADJUSTABLE GRATE

REG. \$5.95
NOW \$3.95

Imported cast iron 10x10" with removable inside grate, wood base and stay-cool wood handles.

CHARCOAL CADDY

Lightweight polystyrene carrier with large capacity, strong pour spout.

REG. \$1.27
NOW 88c

ADJUSTABLE DOUBLE HIBACHI

REG. \$9.95
NOW \$6.95

Cast iron hibachi with twin grates, double draft doors on wood base, stay-cool wood handles. 17x10x7".

WIRE FOLDING FENCE

White DuPont vinyl coated interlocking fencing for decorative protection.

10' long x 18 1/2" x 1.29

BELTMORE'S INTERIOR LATEX PAINT

2 gals. \$5.00

Tested for durability, washability, coverage, quick-dry. White, and decorator colors.

REG. \$3.99 Gal.

INTERIOR OR EXTERIOR

\$1.59 Quart

Lab. tested for washability, color fastness. Covers most surfaces in 1 coat. White, 18 colors. Reg. 1.89 qt.

LAWN CHARMERS... MAMA AND DUCKLINGS

sale 2.77 set

After sale 2.99

3 1/2" white mother duck, three 7" yellow babies molded of high impact Styrene to resist weather.

Idaho News

YOUTH SESSION SET
BOISE (AP) — A wide range of legislation has been proposed for the annual Idaho YMCA Youth Legislature, scheduled Friday and Saturday in Boise.

Bills which will go before the young people were introduced by local YMCA sponsors throughout the state. They include such proposals as legalization of abortion and by prescription of LSD drugs.

Another measure would provide a method for an independent presidential candidate to get his name on the election ballot.

BIDS CALLED FOR
BOISE (AP) — The State Highway Department called Wednesday for bids on three road jobs, two on the interstate highway system.

Bids will be opened May 7 on reconditioning Interstate 80N in Cassia and Oneida counties. Bids will be opened May 14 on widening Interstate 15 from Pleasant Valley to the Montana State Line in Clark County. The department said it will use bid April 23 on selecting about 24 miles of U.S. 30N from Soda Springs to Emmett, and about 10 miles of Idaho 34 from Cleveland to Thatcher in Caribou, Franklin and Bear Lake counties. The project also involves providing of aggregates in stockpiles near Montpellier and Soda Springs.

Labor Camp Board Lists Fee Schedule

BUHI — Members of the West End Labor camp board established a fee schedule to be paid by the non-members of the association for 1968 at the April board meeting.

Local board members noted that requirements for improvements made by the State Health Department and the local government at the camp will require added funds—and that if the association fails to remain self-supporting in financial matters, the increased fees were a necessity.

During the coming season the fee for wedding crops other than sugar beets will be \$1 per acre. General day labor will be \$1.50 per day per laborer with beet growers except due to their regular financial pledge to the camp through the association.

Reagan Going To Make Assessment

SACRAMENTO, Calif. (AP) — Gov. Ronald Reagan "will be 'Obviously, I'm going to try and make an assessment' after hearing a report by a Republican political strategist that there is growing grassroots support across the country for a Reagan presidential bid."

"I'm certainly not going to run away and pretend it isn't happening," Reagan told a news conference Tuesday. He outlined a new speaking tour for the Midwest, South and Hawaii starting April 23.

A report prepared by F. Clifford White, a former Barry Goldwater aide now advising Republican "convention" delegates in California, was discussed by Reagan.

"There seems to be an increase in the grassroots movement in my behalf," Reagan said. He said he still considers himself only a favorite son candidate but acknowledged that an approaching tour will make it more difficult to convince people that he is not a presidential candidate.

Reagan said, however, he refuses to "get frightened into staying home and not doing what I can for a cause that I believe is very important because, frankly, I don't believe this country can afford four more years of the lack of leadership that we have had under the other party."

The former actor, in his first term as California's governor, said he would meet with Gov. Nelson A. Rockefeller of New York and three other Republican governors to discuss the party platform.

Reagan will act as host to Rockefeller and Gov. Raymond P. Shafer of Pennsylvania, John Love of Colorado and John Chafee of Rhode Island at a meeting May 8 in San Francisco.

Buying or Selling REAL ESTATE Use Classifieds Classifications 50 through 62

EXECUTIVE NAMED
BOISE (AP) — Appointment of Dr. Richard E. Bullington as executive vice president of Boise College has been announced. President John B. Barnes said the appointment is effective July 15.

Bullington now is professor of education and chairman of the department of education at Arizona State University.

ENTERS RACE
NAMPA (AP) — State Rep. Leon H. Swanson, Nampa, announced Tuesday he is a candidate for the state senate seat being vacated by Sen. R. H. Young, Nampa.

Both are Republicans. Young has announced the press of his private business will prevent his running for another term in the legislature.

HEARINGS SET
BOISE (AP) — Suppression of fires on Idaho range lands will be the subject of hearings in Boise and Lewiston this week by a subcommittee of the Idaho Legislature's Interim Fire Study Committee. The hearings will be held Tuesday, Wednesday and Thursday.

The hearing, presided over by State Sen. Lloyd Barron, R-Fairfield, will be Friday in the Capitol and Wednesday in Lewiston. It will be held in the library at Lewis-Clark Normal School in Lewiston.

COURT CLERK DIES
BOISE (AP) — Louis J. Bideganeta, 54, for nearly 10 years clerk of the Idaho Supreme Court, died Wednesday after a lengthy illness. He retired from the court position two years after serving from Jan. 1, 1957.

Busy Day

HUNTINGTON, W. Va. (AP)—April 12 was a busy day for Charles E. Hitchcock, his new bride charged him with bigamy and his first wife gave birth to a son.

Hitchcock, 27, of Wayne County, appeared in court Tuesday, waived a hearing on his financial charges and was held for grand jury action.

Actress Fay Bainter Dies At 74

HOLLYWOOD (AP) — Fay Bainter, stage and Oscar-winning screen actress, died Tuesday at her home. She was 74.

Her husband of 42 years, Navy Lt. Cmdr. Reginald Venable, died Sept. 28, 1964. Their actor son, Reginald Jr., survives.

Miss Bainter was a Los Angeles native who entered movies at 14 after long stage experience. She won the Academy Award as Aunt Belle in "Jezebel," whose star, Bette Davis, also received an Oscar.

Miss Bainter was nominated for the prize for two other roles — Claude Rains' housekeeper who believed in surrendering in "White Banners" and a grandmother deceived by a man in "The Children's Hour." She appeared in a total of 29 films.

RESOLUTION ADOPTED
COLUMBIA, S.C. (AP) — The South Carolina House of Representatives has unanimously adopted a resolution expressing regret at the death of Ernest T. Redd Sr., a Negro bellboy at a Columbus motel for many years.

MOON-GLO DRIVE-IN
IN BUHL — Thurs. - Fri. - Sat. - Sun. Double Feature Program

James COBURN
BLAUG EDWARDS

Waterhole #3
PLUS CO-HIT

DAVID JANSSEN
has got to know in **WARNING SHOT**

Ferber Leaves Many Books

Novelist Projected America



NOVELIST EDNA FERBER, 82, died Tuesday in New York. She won the Pulitzer Prize in 1924 for her novel "So Big." (AP wirephoto)

Poll of 80 Editors Shows Majority Predicting Humphrey-Nixon Contest

WASHINGTON (AP) — A poll of 80 newspaper editors shows a majority predicting a contest between Vice President Hubert H. Humphrey and former Vice President Richard M. Nixon.

The poll, conducted by the American Society of Newspaper Editors' annual convention, showed 53 percent of editors favoring Humphrey and 47 percent favoring Nixon.

Humphrey, still silent on his political plans, was stamped an incumbent administration party following backing from labor and solid support in the South.

"I think the organization will take it in the end. It usually does," said H. P. Nicoll, editor of the Cincinnati Enquirer, credited Humphrey with labor support.

Sen. Eugene J. McCarthy, D-Minn., like Kennedy a declared candidate for the Democratic nomination, didn't receive a single vote in the sampling.

On the Republican side, Nixon found a majority predicting the only declared GOP candidate was a prohibitive favorite over such potential challengers as New York Gov. Nelson A. Rockefeller and Gov. Ronald Reagan of California.

Those picking Humphrey credited him with the advantages of an incumbent administration party following backing from labor and solid support in the South.

"I think the organization will take it in the end. It usually does," said H. P. Nicoll, editor of the Cincinnati Enquirer, credited Humphrey with labor support.

Sen. Eugene J. McCarthy, D-Minn., like Kennedy a declared candidate for the Democratic nomination, didn't receive a single vote in the sampling.

NEW YORK (AP) — Edna Ferber, who insisted she never needed to experience a situation to write about it, leaves in death a legacy of books—plays—and short stories vividly portraying the American scene.

A splinter at her death Tuesday at age 82, she is recalled in reference to her written works:

"Unmarried female writers have not as many as their wedded female contemporaries. They can lavish more time and energy on their children, of which—unlike spinsters—they have had 32—or is it 33; one losses count."

Two of those "children" included "So Big," her Pulitzer Prize winning novel of a Chicago area woman truck farmer and "Show Boat," depicting life aboard Mississippi's floating theaters and later turned into a three-revived Broadway play and "Three Men on a Horse" which was made into motion picture.

Other Ferber novels, most of which were made into motion pictures included "Cimarron," a tale of Oklahoma's early days, "Saratoga Trunk" and "The Sign in Snow" which was made into motion picture.

Over the last several months she had been ill, and in and out of hospitals. Death came in her Park Avenue apartment where she had been confined.

Over the last several months she had been ill, and in and out of hospitals. Death came in her Park Avenue apartment where she had been confined.

Over the last several months she had been ill, and in and out of hospitals. Death came in her Park Avenue apartment where she had been confined.

Over the last several months she had been ill, and in and out of hospitals. Death came in her Park Avenue apartment where she had been confined.

Over the last several months she had been ill, and in and out of hospitals. Death came in her Park Avenue apartment where she had been confined.

Humphrey Strategists Grapple With Problem

By JACK BELL
AP Political Writer

WASHINGTON (AP) — With Vice President Hubert H. Humphrey's political strategy strength rising, his delegates are grappling with the problem of how to win the Democratic presidential nomination without New York or California.

The two biggest states together cast 36 of the 1,112 votes needed for nomination at the August convention in Chicago, which Humphrey's strategists believe offers him the best chances of getting more than a handful of free votes in the early balloting are considered negligible.

There is some talk of an effort to swing to Humphrey a California state of candidates put together for President Johnson under the leadership of State Atty.-Gen. Thomas C. Lynch. But Democratic National Committee member Am Alabon has balked at such an arrangement.

In New York, Humphrey's backers expect to pick up scattered support in a 19-state caucus which now is being conducted by Sen. Robert F. Kennedy, D-N.Y., as the base for an effort to blitz the convention into nominating him.

While his delegate hunters are working the field, Humphrey has postponed until next week, and possibly later, any formal announcement of his candidacy. The belief among his strategists is that there is no hurry about giving up his status as a non-candidate. They feel Kennedy has failed to manufacture the background of "So Big," I write "Cimarron" after spending 10 days in Oklahoma.

Over the last several months she had been ill, and in and out of hospitals. Death came in her Park Avenue apartment where she had been confined.

He hasn't got the horses in the South, he used to wear." Charles Pearson, editorial page editor of the Wichita Eagle and Beacon, said Humphrey will have strength "in areas where Kennedy is unpopular, which is a lot of areas."

William B. Dickinson, managing editor of the Philadelphia Bulletin, differed in choosing Kennedy as the best nominee. Dickinson said, "I think he has charisma. I think he has many political skills. And he certainly has ample financing."

Thomas L. Boardman, editor of the Cleveland Press, was one of the four who tapped Johnson for the nomination despite his disavowal.

"I think something will come of the Vietnam peace effort, he won't be able to back away from it," Boardman said.

In making Nixon the runaway Republican pick, many of the editors agreed with Harry L. Sonneborn, managing editor of the Milwaukee Sentinel, but said, "I think he's way out in front at this time."

2nd SMASH WEEK!

"SCIENCE FICTION WITH A REAL STINGER IN ITS TAIL. A startling revelation of things as we know them in earth. The great apes are in charge; mankind is regarded as speechless, brainless primitives who overbreed, and must be hunted."

"A BLOCKBUSTER MOVIE! A genuine 14 carat film. Big, fascinating, totally entertaining!"

CHARLTON HESTON

PLANET OF THE APES

TONIGHT 7:00 & 9:25 p.m.

ORPHEUM PRICES ADULTS \$1.75 CHILDREN 50c

2nd LAUGH WEEK!

NOW! AT TWO THEATRES

IT'S THE MOST HILARIOUS HAUNTING INFILTRATION!

WALT DISNEY PRESENTS BLACKBEARD'S GHOST

TECHNICOLOR® featuring **USTIROV** and **PLESHETTE**

CONTINUOUS **IDAHO** DOORS OPEN 6:15 P.M.

MOTOR-VU DRIVE-IN Starts TONIGHT 2 - ALL-GO-FOR HITS... FOR YOUR OUTDOOR FUN!

PHONE 233-6276

U.S. 30 East to Eastford Drive

At 7:45 - 11:00 p.m.

WINNER OF 5 ACADEMY AWARDS

BEST ACTOR, ROD STEIGER

and the Biggest and Best Picture of the Year!

Also Winner of 3 Other Awards THE MIRISCH CORPORATION Presents

"SIDNEY POITIER" "ROD STEIGER's is good in "Guess Who's Coming To Dinner", better in "To Sir With Love", best of all in "In The Heat Of The Night!" —TIME MAGAZINE

"THE RUSSIANS ARE COMING THE RUSSIANS ARE COMING"

PLUS CO-HIT NO. 2 AT 9:30 P.M.

BANANA SPLIT SALE

APRIL 18th & 19th

Dairy Queen

Banana Splits are on sale at your nearby Dairy Queen. Cool swirls of refreshing Dairy Queen piled high with your favorite toppings. "Live a Little"™ at Dairy Queen during the Banana Split Sale.

TWIN FALLS DAIRY QUEEN 379 Adair Ave. W. WINE TWIN FALLS, IDAHO

Shoshone Meet Raps Salary Hike Request

By MELBA THORNE
Times-News Correspondent
SHOSHONE — Charges that the extension service of the United States is not properly handled here Monday night. Carl Youngstrom, county commissioner, said the increase from each county over the last year has been leveled at the agency's director. Youngstrom has refused to meet with the group, stating that the only meeting with county commissioners was held here Monday night. "We had to go through the meeting here Monday night," Mr. Youngstrom said. "The public meeting was called by the Lincoln County Taxpayers' Association and held by Don Rove after Mr. Youngstrom was challenged for not attending in Shoshone. The state official pointed out agents and to keep competent in defense of the request for people we must maintain a good increase from each county, that was introduced by D. the federal and state share of the budget, president of the Lincoln county agent's budget has-

increased from two to four times more than the county participation since 1951, when the counties assumed payment of \$1,000 toward the agent salaries in their county. The current \$500 hike requested this year would be divided between salary increase and other needed expenditures for operation of the county work. Mr. Youngstrom said. Only three counties are objecting to the increase, all of them in Magic Valley. "Most of the counties have indicated they are willing to support the program as outlined by the state extension service," the official declared. Various phases of the state budget were challenged by participants at the meeting. Mr. Rove said the transportation item was raised and that wages of the assistant county agents, averaging \$9,672 for 1957-58, is sufficient. Mr. Hilt declared the county agent's salary is out of line compared to other county officers' salaries, and in most cases are double those of other county officials. Floyd Silva declared average income in Idaho is down and many places in the extension service budget can be cut without harming the local services. "I don't care how you have brainwashed county commissioners across the state, we'd better cut down. We need to cut out all the fat in all departments," he stated. John VanOrman, Jerome county commissioner, said their county had not agreed to grant

State Employee Seat Belt Rule Draws Fire

MOSCOW, Idaho (AP) — Gov. Don Samuelson's new seat belt rule for state employees drew protest Tuesday from the Idaho State Board of Education meeting here, which said colleges and universities cannot comply with the edict.

The board also objected to the voluminous questionnaires sent to colleges and universities by state agencies and called for a conference with the governor to work out the problem. Dr. William Davis, president of Idaho State University, joined others in questioning the new seat belt edict that requires state employees to use the safety belts when traveling on state buses. Davis said he must personally sign a statement saying that the faculty member or staff mem-



WINNERS IN TWIN FALLS competition of the state employ the handicapped poster artist, from left, Robert Stuart Junior High students John Warberg and Cindy Kopp, and High School students Rosalyn Wagner and Mark Nikkin. Miss Kopp won first, Mark Nikkin got second, Miles Wagner

was third and John Warberg was fourth in the contest. Mrs. Ellen Quessell is Junior high instructor and George Walton is high school instructor in the contest. Both are seen here. Miss Kopp's poster will be judged in state competition later this year.

3 On CSI Housing Board "Fired," Then "Rehired"

Letters of resignation from the three members of the College of Southern Idaho housing commission were accepted Tuesday night — with displays of amusement. The board of trustees had earlier been forced to request that the three members resign and be reappointed.

Giving Up

CHICAGO (AP) — Cornelius Jones has given up on marriage, but not because he has outlived seven wives and not because he's nearly 107 years old. "I don't think I'm too old to get married," Jones said. "But I just decided I'm not going to ask anyone to marry me."

Elks Contest Winners Listed

JEROME — Winners in the Elks' Americanization contest were Michelle McLean for the Junior High School and Marlene Peterson for the high school. They each received a \$50 bond. The subject was "My Responsibility as an American." Other winners who received \$25 bonds were Dain DeLuca, Calvin Humphreys and Gwen Perkins, seventh grade; Nancy Burkhalter, Patty Sonnichsen and Sandra Thibault, eighth grade; Linda Vining, Barbara Merritt and Kris Pharris, ninth grade. Geri Thurston, Judy Blades and Conie Thompson, sophomores; Joyce Putman, Lana Dee Brackenbury and Nancy Williams, juniors; and Pam Garbrandt, Connie Prescott and Mike Haddock, seniors.

Film Shown Glenns Ferry C. of C. Meet

GLENN'S FERRY — Cecil Worthington, Mountain Home, showed a film on Hellen Canyon at the Monday noon meeting of the Glenns Ferry Chamber of Commerce.

Meet Set

JEROME — The Tri-State meet of the Horseless Carriage Clubs to be held May 10-12 at Indian Hot Springs, American Falls, was a go on a c.d. when the Gooding Horseless Carriage Club met at the Twin Falls Idaho Power auditorium. Walter Rudolph, president, said Ralph Sisco showed slides on forestry. Refreshments were served by the Twin Falls group.

ATTACHES ACCUSED MOSCOW (AP)

The government newspaper Izvestia today accused four U.S. military attaches of oversteering the bounds of propriety seeking information and implied that they had spied at a shipyard and a military base.

WORKSHOP BEGINS ELLENSBURG, WASH. (AP)

Forestry leaders and Bureau of Indian Affairs employees from three states began a three-day workshop at Central Washington State College today.

Blue Pencils Won

Blue pencils were won Monday night by Wayne DesPain, Ken Reid, Cheryl Wain and Jandi Dougherty at the regular meeting of Toastmasters Club No. 793.

Next Monday Bill Ringear

a Boise city attorney, will talk on the legal aspects of the desert land entry problems, and answer questions.

Blue Pencils Won

Blue pencils were won Monday night by Wayne DesPain, Ken Reid, Cheryl Wain and Jandi Dougherty at the regular meeting of Toastmasters Club No. 793.

Blue Pencils Won

Blue pencils were won Monday night by Wayne DesPain, Ken Reid, Cheryl Wain and Jandi Dougherty at the regular meeting of Toastmasters Club No. 793.

ALLIED
1
Call your local
WARBERG'S
MOVING & STORAGE
agent 733-7371

TREES SHRUBS
Several Different Varieties
YOUR CHOICE... \$1.29
GARDEN SEEDS
SEED POTATOES... 6c.-LB.
● ONION SETS
● ONION PLANTS
● BULBS
TWIN FALLS FEED & ICE, Inc.
"OPEN 24 HOURS" 7 DAYS A WEEK
135 5th AVE. SOUTH 733-1297

ROPERS' SMART NEW SUITS
For Graduation and College in the Fall

YOUNG IN BUILD
and
CRISPLY FASHIONABLE

Light and zight... with natural shoulder, 3 button style with hook center vent... herringbones... Glen plaids.

CAMPUS TOMS
by Louis Goldsmith
\$55.00 to \$69.95

Manchester Natural SHOULDER SUITS
\$55.00 and \$59.95

HENDRIX SQUARE
\$59.95 and \$65.00

ROPERS' Variety Shops have the best Graduation Gifts... Shirts... Ties... Belts... Jewelry... and many others.

USE YOUR ROPERS' OPTION CHARGE OR BANKAMERCARD OR WALKER BANKARD

ROPERS'
If it's from ROPERS'... It's RIGHT!
TWIN FALLS - BURLEY - RUPERT - BUHL

Year's lowest prices on Ford XL's... Mustang Sprints... Fairlane hardtops!

Ford's See-the-light Sale!

Save on Ford XL's with air conditioning! Talk about detail! You'll see the like of this one again if you wait all year. Our top-of-the-line XL Fastback is now on sale with a Factory-installed air conditioning. Tinted windshield and windows. • 302-cu. in. V-8 • High-performance axle • Disappearing headlamps • Die-cast grille • GT stripes • Dual side air outlets • No extra cost! But hurry! These Mustang Sprints are going fast!

Save on Mustang Sprints! Here's your chance to get the best selling sports car in the world... loaded with special equipment you never could get at this price before! • GT stripes • 200-hp open class 6-cyl. V-8 • 3-spoke steering wheel • 15" wheels • 4-spoke covers • Sport trim • GT V-8 and also save on • Wide-oval tires • Sixty-four wheel covers • "GT" fog lamps • Buckets, floor-mounted stick, carpeting come at no extra cost! But hurry! These Mustang Sprints are going fast!

Save on Fairlane Hardtop! Special savings, too, on America's most popular intermediate! Specially equipped Hardtops with • Vinyl roof • Sporty wheel covers • White side wall tires • Smart accent side moldings • Plaid vinyl upholstery.

FORD
See the Light! The switch is on to Ford. • 1968 • Shows a better deal.

FAIRLANE WINS MOBIL GAS ECONOMY RUN CLASS C, AVERAGING 22.7 MILES PER GALLON.

Use of Mobil Economy Run is approved and certified by the United States Auto Club.



Northwest's #303 cans
APPLESAUCE 3 cans 49¢

Märlene 1-lb. cartons
MARGARINE 5 lbs. 89¢

TABLERITE

MASSIVE Beef Sale!

1/2 BEEF

TABLERITE CUT AND WRAPPED FOR YOUR FREEZER OR LOCKER

53¢ lb.



Chuck Roast



Tablerite U.S.D.A. CHOICE **45¢ lb.**

PUREX.....29¢ SAVE 40c

IGA Quart Pink Liquid **DETERGENT.....69¢**

IGA PIGGY BACK SPECIALS
MEAN MORE SAVINGS TO YOU!
NBC 1-lb. Saltines
CRACKERS.....26¢ box

—WITH THE PURCHASE OF—
Campbell's #1 Can
TOMATO SOUP

2 CANS 29¢

SAVE 11c

COMBINATION MUST BE PURCHASED FOR PIGGY BACK SAVINGS!

Gallon Bottle

New! ADVANCED
all
WITH RACH AIR FRAGRANCE
CONTROLLED LOW SUDS FOR THE CLEANEST CLOVES BY AUTOMATIC WASHING

30c OFF
JUMBO SIZE
Advanced
ALL 1.99

- | | |
|--|--|
| BUIH
Eck Bros. IGA
BURREY
Clark's IGA
CAREY
Don's Food Bank
DIELO
Devle Market
FAIRFIELD
Market Basket
FLECK
Jordan's Market
Pointe's IGA
HAGEMAN
Owley's Market
HANSEN
Anna's IGA | HATZELON
Mike's Market
KIMBERLY
Persch's IGA
JEROME
Meyer's IGA
MURTAUGH
Thomas's IGA
OARLEY
Clark's Far Shopping
RICHFIELD
Piper's Shopping Center
SUPER
Foodland IGA
TWIN FALLS
East Side Market
Marty's Market
WENDELL
Cash Grocery |
|--|--|

25c OFF 3/4 gallon Cold Water
ALL .. 1.99

SAVE!
Cold Water Surf
For COLD or HOT Water Washing

15c OFF Giant Size
SURF .. 69¢

Breeze
Liquor
Giant Size

15c OFF Giant
BREEZE 69¢

15c OFF KING SIZE
LIQUID LUX 65¢

LUX
EXCLUSIVE Hand Care FORMULA
with Dermasil
Luxuriant Softening Detergent

25c OFF GALLON
WISK 2.69

Final Touch
DELUXE FABRIC SOFTENER

20c OFF KING SIZE
FINAL TOUCH 1.19

MEAT POLICY
OUR AIM...
To offer you more pounds and a greater selection of cuts of edible meat for your money consistent with a high level of eating quality.

OUR PRINCIPLES...

1. Every Tablerite meat purchase is guaranteed fresh and wholesome.
2. All Tablerite meat is trimmed of all excess fat, bone, and waste before wrapping to assure you more meat.
3. For your money.
4. All Tablerite meat sold in IGA stores is personally selected by meat experts to meet specifications assuring you eating satisfaction.

OUR RESPONSIBILITIES
To guarantee that each and every Tablerite meat purchase you make at an IGA store is completely satisfactory or we will refund the purchase price you paid and replace your purchase free of charge.

Tablerite USDA Choice BONELESS
CHUCK ROAST Lb.... 69¢

Tablerite USDA Choice LEAN
CHUCK STEAK Lb.... 49¢

Tablerite USDA Choice LEAN
GROUND BEEF 3 Lbs. 1.39

Falls Brand CHUNK
BOLOGNA Lb..... 39¢

corn crinkles
corn crinkles
TOSTADAS 49¢ pkg.

MILK 7 TALL CANS \$1
EVAPORATED (10c OFF)
TANG 41¢
Quart Salad Dressing

TABLERITE ROUND
CHEESEBURGER 8-slice 29¢
CHEESE SLICES pkg.

Tablerite All Flavors 1/2 GAL.
ICE CREAM.... 79¢

RITZ
NBC RITZ CRACKERS
1-lb. box 39c

STRAWBERRIES
RED RIPE **4 CUPS 89¢**
Controlled Atmosphere Washington Red
DELICIOUS APPLES..... 4 L \$1

IDAHO No. 1 RUSSETS 10 lb. bag 39c

FROZEN FOODS
BANQUET 14 OUNCE
CREAM PIES
Your Choice of 6 Flavors
4 FOR \$1.00

- Tablerite 1-lb. Mild MIDGET HORNS 79c
- Tablerite Box, 1000 Island or RUSSIAN DRESSING 31c
- IGA 20-ounce CATSUP 31c
- IGA Carton of 50 BOOK MATCHES 2+29c
- American Beauty 24-oz. ELBO MACARONI 37c
- Hunt's Box TOMATO SAUCE 5 cans 59c
- Meadow Gold — Quart BUTTERMILK 26c

Magic Valley Obituaries

Funeral Services

Funeral services for Glen H. White, Twin Falls, will be conducted at 2 p.m. Friday in White Mortuary Chapel by Bishop G. Brown. Burial will be in Sunset Memorial Park. Friends may call until 1:45 p.m. Friday at the mortuary.

RUPERT — Funeral services for Mrs. Lydia Himmig, 67, Rupert, will be held at 2 p.m. Saturday in the Trinity Lutheran church. The Rev. L. G. Metzner will officiate and final rites will be held at the Rupert Cemetery.

Photographer Is Killed In Student Riots

BOON, Germany (AP) — An Associated Press photographer today became the first fatality from the wave of student riots in West Berlin and West Germany as the government demanded how to calm the militant leftist students.

Cranial surgery failed to save the life of 25-year-old Klaus Frings, a German, who was hit in the head by a stone Monday night while covering a battle between police and student demonstrators in Munich. His condition worsened after the operation, and he died early today.

Wes Gallagher, general manager of The Associated Press, called Frings' widow that her husband "dies many of others of the profession of journalism who have given their lives in peace and war so that the public could be kept informed."

Police said earlier they had arrested 21-year-old Rainer Gohs, who was suspected of throwing the stone from behind a bush in a dark park.

Minister Dies

Funeral services for the late Rev. Paul Minn, reportedly of a heart attack, appear relatives in Clatsop County. The former minister of the Highland Church of Pentecostals, 212 Tyler St., white living in Twin Falls.

Bids Opened For Highway Construction

BOISE (AP) — The State Highway Department opened bids Tuesday on close to \$300,000 worth of highway projects in Owyhee, Fremont and Bonneville counties.

Aslet Construction Co. of Twin Falls was the apparent low bidder on a \$100,000 resurfacing project on Interstate 15 from Bassett to the Bonneville-Bingham County line.

An offer by Kimberly Construction Co. of Kimberly was the apparent low bidder on a construction and surfacing project on the Elkhorn Dam extension between the dam and Daniels' Kennedy Paving Co. of Idaho Falls apparently outbid another firm for the construction in three separate paving projects: \$84 miles of U. S. 101 on Henrys Lake Flat; five miles of Idaho 81 between Mack's Inn and Big Springs; and nine miles on Idaho 87 from U. S. 101 to Reynolds Pass.

CARTOONIST NAMED

SHOSHONE — Verleen Stimpson, daughter of Mr. and Mrs. Veral Stimpson, former Shoshone resident, has been named a cartoonist for the Capitol High newspaper at Boise. She is a sophomore there and recently wrote an article for the paper. She is a granddaughter of Mr. and Mrs. Lee Sullivan and Mrs. Mrs. W. P. Stimpson, Shoshone.

REVENUES INCREASE

PORTLAND (AP) — Pacific Power and Light Co. says an upturn in the lumber and plywood industry has increased operating revenues and net income by about 10 percent in the first quarter of 1968.

Educational TV Network Plans Okayed

BOISE, Idaho (AP) — Plans for a study of possible creation of a multi-state educational television network were approved Thursday by directors of the Federation of Rocky Mountain States.

A two-day meeting of the federation adjourned Tuesday after calling on the National Educational Television network to extend and improve its service to Moscow, Idaho; Las Vegas, Nev.; and Logan, Utah.

In another resolution, the federation appealed to the Interstate Commerce Commission to include an "equitable formula" in any freight rate increases allowed, instead of the flat percentage sought by railroads.

The federation asked for congressional support in implementation of a Rocky Mountain States transportation plan, recognizing "the need for improved north-south services."

Earlier, the federation adopted a resolution approving efforts "to explore the possibilities and practicalities of a plan for solving water supply problems of the 17 western states and western Canada."

The federation heard a proposal by Lewis C. Smith, a Denver engineer, for transporting water from the Great Slave Lake in Canada's Northwest Territories.

The \$75 billion project would divert water to all of the western United States. The water would be transported across the border via the Columbia River system and distributed to the Salmon, Snake, Green, Colorado, Missouri, Rio Grande and other rivers in the West.

The federation on Monday admitted Nevada to membership. Other members are Idaho, Utah, Colorado, Wyoming, Montana and New Mexico.

Television Schedule

Wednesday, April 17, 1968
PROMISING SPECIALS:
 5:30 p.m. 8; 6:30 p.m. 4—Special, "Our Time In Hell." Ex-Marine Lee Marvin narrates this combat log of the Marines landing-hopping Pacific campaign in World War II.
 7 p.m. 7B; 9 p.m. 25L—Julie Andrews Special—Gene Kelly and the New Christy Minstrels join Julie on this award-winning.

5:30 25L—News, Sports
 2B—News, Sports
 3—Love In Space
 4—Lawlike
 5—News
 7B—News, Weather, Spis.
 8—Special, "Our Time In Hell"

11—Lost In Space
 6:00 25L—News, Weather, Spis.
 5—News
 2B—Ernie Kovacs Special
 7B—Garrison's Gorillas
 75L—Let's Speak English
 6:10 75L—Misttengers
 6:30 25L—Virginian
 3—Beverly Hillbillies
 5—Beverly Hillbillies
 11—Beverly Hillbillies
 6—Virginian
 4—Special, "Our Time In Hell"

6:40 75L—Friendly Giant
 7:00 2B—Green Acres
 3—Green Acres
 5—Green Acres
 11—Green Acres
 75L—What's New
 7B—Julie Andrews Special
 3—He and She
 5—He and She
 7B—Ocean House
 75L—Retrospect
 11—Please Don't Eat the Daisies

6:30 25L—Julie Andrews Special
 6—Julie Andrews Special
 4—Movie, "Zazou"
 3—Movie, "Move Over"
 Darling
 2B—Jonathan Winters
 11—Jonathan Winters
 5—Movie, "Sweet Bird of Youth"

For a New Chevrolet of one of our many low used cars
 SEE AL JENKINS
 212 Main St.
 Glen Jenkins Chevrolet

Trustees Okay School Budget At Murtagh

MURTAGH—The fiscal budget for 1968-69 was approved and the budget hearing set for April 30 at the trustee meeting Tuesday night at the high school.

School officials reported that teachers' contracts have been accepted and signed. Mrs. O. E. Wright and Mrs. Gertrude Dreyer both are retiring. Teachers' applications were reviewed.

The schedule for several upcoming events was also with the annual Awards banquet scheduled for April 30 and the Junior-Senior banquet for April 27.

The trustee election was set for May 14 with polls open from 1 to 7 p.m. Trustees will be elected in June. Some representatives by Ken Davis, and zone 5, represented by James Perkins.

4—News
 11:30 4—Joy Bishop
 11:40 25L—Movie, "Pursuit to Algiers"
 12:00 25L—Movie, "Petty Kelly's Blues"

each for a three-year term. The next regular board meeting will be held May 14, because of the high school graduation, with the meeting to convene immediately after the eighth grade graduation.

YOU DON'T HAVE TO BE DUTCH TO ENJOY OUR TULIPS! YOU CAN EVEN BE SCOTCH!

(You'll be surprised how inexpensively you can grow your home with fabulously realistic false flowers.)

Bring Spring into your home with an exquisite arrangement of authentic spring blooms from Fox Floral.

Come In Tomorrow!

fox floral
733-2674

YOUR HOME-TOWN INDEPENDENT DRUG STORE

Crowley

PHARMACY

DOWNTOWN TWIN FALLS 733-9771

- Senior Citizen Prescription Discount
- Our Pharmacists are Always On Call
- CHARGE ACCOUNTS AVAILABLE
- Free Prescription Pick-Up and Delivery
- PERSONALIZED SERVICE
- INDEPENDENT DRUGGIST
- Gold Strike Stamps With Every Purchase

PRICES EFFECTIVE: Thursday, Friday and Saturday. We reserve the right to limit quantities. No sales to dealers.

Not every woman wants to be Blonde.

Some just want their own natural color to be more beautiful. A shade lighter... darker. Or just the gray erased.

For you, there is the new Shampoo-In Technique—the exciting new dimension in haircoloring that takes you just this side of your own color... just this side beyond... as it colors hair effortlessly, conditions luxuriously.

Try new Shampoo-In Technique, a natural in 12 shades for brunettes, redheads... even for blondes!

Mitchum ANTI-PERSPIRANT
 Liquid or Cream 60-day supply Each \$3.00

THIS WEEKS SPECIALS

Assorted flavors liquid
SEGO DIET 4 cans **88¢**
 Reg. 89¢ Prophylactic
TOOTHBRUSHES 2 for **49¢**
 Reg. 3.04 16-oz. bottle
PHISOHEX **\$1.88**

TUSSY DEODORANT
 TUSSY CREAM
 TUSSY ROLL-ON
 TUSSY-STICK
50¢ EACH
 REG. \$1.20 EACH

TUSSY DEODORANT GIVES ALL-DAY PROTECTION.

TUSSY CREAM 6-PACK \$3.00
 REG. \$6.00

plus Big Family Size
TUSSY SPRAY DEODORANT \$1.00
 REG. \$1.50

Run-Pruf Hose ... pair \$1.49
 Like LondonAire & Ricardo, we think they're better!
 Big 12-oz. Reg. 1.49
RIOPAN ANTACID **99¢**

18-oz. mouthwash
MICRIN reg. 1.45 **93¢**
 Kotex 40's, reg.-super
Tampons 1.69 .. **99¢**

STYLE
HAIR SPRAY
 99¢ CAN WHY-PAY MORE?
48¢

Tempo BLUE LAKES SHOPPING CENTER

SHOP WEEKDAYS 9 A.M. TO 5 P.M. SUNDAYS 12 TO 5 P.M.

COUPON SALE!

3 DAYS ONLY! CLIP AND SAVE AT TEMPO!

<h3>TEMPO COUPON</h3> <h4>NYLON BRIEFS</h4> <p>compare at 79¢ 43¢ with coupon</p> <p>White, pink, blue, mint or maize. Sizes: 5-8.</p>	<h3>TEMPO COUPON</h3> <h4>MISSIE'S CAPRIS</h4> <p>regularly 3.88 2.88 with coupon 26% off</p> <p>Belled cotton gabardine slacks in sizes 10-18.</p>
<h3>TEMPO COUPON</h3> <h4>RIGHT GUARD</h4> <p>king-size deodorant \$1.00 with coupon 57¢ with coupon</p> <p>2-second spray gives 24-hour protection. 4-ozs.</p>	<h3>TEMPO COUPON</h3> <h4>2 LBS. COOKIES</h4> <p>\$1.29 size box 88¢ with coupon</p> <p>Fancy assorted cookies packed in paper cups.</p>
<h3>TEMPO COUPON</h3> <h4>SAVE 10¢! POPCORN</h4> <p>regularly 39¢ 29¢ with coupon</p> <p>Temporarily seasoned and ready to eat; 12-oz. bag.</p>	<h3>TEMPO COUPON</h3> <h4>18" BOLSTER</h4> <p>compare at \$1.49 99¢ with coupon</p> <p>Foam filling, print or plain covers. 7" diam.</p>
<h3>TEMPO COUPON</h3> <h4>SAVE 39% NYLONS</h4> <p>regular 2 prs. 78¢ 47¢ with coupon</p> <p>Seamless run-resistant mesh. Nude heel. 8-11.</p>	<h3>TEMPO COUPON</h3> <h4>CLUTCH BAGS</h4> <p>regularly 97¢ 77¢ with coupon 20% off</p> <p>Grained or shiny patent vinyls. Popular colors!</p>
<h3>TEMPO COUPON</h3> <h4>SPORT SHIRTS</h4> <p>compare at \$1.98 \$1.48 with coupon</p> <p>Men's cotton shirts in assorted styles. S-M-L.</p>	<h3>TEMPO COUPON</h3> <h4>SHORTY PJS</h4> <p>compare at \$1.98 \$1.44 with coupon</p> <p>Girls' 4-14 cotton pj's with lace, ruffle trim.</p>

Annual 12 PRICE SALE

It's stock-up time
TUSSY DEODORANT

plus Big Family Size
TUSSY SPRAY DEODORANT \$1.00
 REG. \$1.50

Pick the Tussy Deodorant that suits you best!

STYLE
HAIR SPRAY
 99¢ CAN WHY-PAY MORE?
48¢



SAVE SAVE
HERE!! MORE!!
SAVE SHOP and SAVE HERE
EVERY DAY!!



AD EFFECTIVE APRIL 17th thru APRIL 21st

Store Hours: Weekdays 9 a.m. to 9 p.m. — Sunday 10 a.m. to 7 p.m.
 Limit Rights Reserved — No Sales to Dealers

You Can Depend on Your Osco Pharmacist

RELY ON OUR PHARMACIST'S FRIENDLY SERVICE . . . In our Osco Drug Prescription Department, the first order of business is your good health. Whatever your needs — be it a simple home remedy or a prescription compounded, we are prepared to serve you in a manner that reflects our pride in the profession of pharmacy.



"Always on Duty to Serve Your Family"
 Phone 733-0342

FISHING SUPPLIES

NEW CHEST HIGH STOCKING FOOT WADERS

COMPLETE WITH SUSPENDERS ASST. SIZES **\$2.88**

LIFE JACKETS

\$4.95 Childs Size **\$2.99**
 \$5.59 Adult Size **\$3.49**

GARCIA - MITCHELL ROD AND REEL COMBINATION

Model 304 reel and Model 23208 6 1/2 ft. rod
KIT PRICE \$14.99

SUBURBAN AERO-DYNAMIC Power Mower

- 20" Vacuum Lift Steel Blade
- 3 H.P. 4 Cycle Briggs and Stratton Engine with Recoil Starter
- Aero-Dynamic Wind Tunnel Deck Design

\$38.88

• Leaf Mulcher Model 318-2

It's here!

Twist Board

The FUN new way to exercise for the whole family

- Tones Muscles
- Burns Calories
- Stimulates Circulation

Mfr. List \$4.95 **AT OSCO special 3.99**

GARDEN HOSE

Extra-Long 60 ft. 1/2" Vinyl Plastic

OSCO LOW PRICE \$1.49

Sturdy Plastic **WATERING CAN**

2 gal. size **99¢**

UNIVERSAL PRESSURE SPRAYER

1 1/2 gal. size **\$6.88** 3 gal. size **\$8.88**

Garden Tools. Reg. \$1.49 **YOUR CHOICE 99¢**

OSCO'S SPECIAL PRICE

New Extra Protection **SECRET Deodorant**

7 oz. \$1.49-size **88¢**

OSCO'S SPECIAL PRICE

EFFERDENT DENTURE CLEANSER TABLETS

96 CT. \$2.19-SIZE **\$1.44**

OSCO'S SPECIAL PRICE

HARDWOOD CHARCOAL

10 lb. bag **48¢**

OSCO'S SPECIAL PRICE

WILSON K-28 GOLF BALLS

3 ball pack **\$2.49**

AN INCREDIBLE OFFER. TODAY'S TOP-SELLING LP'S -

Choose from today's best \$3.79-4.79 Monaural records

	Choose From These Top Hits and Many More at Osco only \$1.97				

OSCO'S SPECIAL PRICE

Rifle Shells

Remington - Winchester and CCI Mini-Mags

89¢ BOX OF 50 LONG RIFLE SHELLS **59¢**

OSCO'S SPECIAL PRICE

9 VOLT **TRANSISTOR BATTERY**

13¢

OSCO'S SPECIAL PRICE

All Metal **STEEL SHELVING**

6' high 3' wide, 18" deep **\$7.77**

OSCO'S SPECIAL PRICE

KOTEX SANITARY NAPKINS

\$1.69 box of 48 **99¢**

Stocks

2:30 P.M. SUMMARY NEW YORK (AP)—The stock market put on a mixed performance today with gains outnumbering losses but the Dow Jones Industrial average taking a loss because of weakness in... It was a parallel performance with Tuesday's... It was a parallel performance with Tuesday's... It was a parallel performance with Tuesday's...

Stocks

Table of stock prices including columns for stock names (e.g., ABC, DEF, GHI), prices, and changes. Includes sub-sections for 'NEW YORK STOCK EXCHANGE' and 'Exchange selected late prices'.

Dow-Jones, 2 p.m.

Table showing Dow Jones Industrial Average components: 30 Stocks (905.28 - 1.50), 20 Rails (23.91 + 1.08), 15 Utilities (123.03 + 0.33), 6 Stocks (241.02 + 0.30).

Livestock

JEROME — Slaughter cows were weak to 50c lower during the week. Feeder cattle were fully steady to 50c higher during the Tuesday sale of Producers Livestock Auction...

Table of livestock prices including categories like 'CATTLE', 'HOGS', and 'LAMBS' with various grades and prices.

Grain

CHICAGO (AP) — Corn and soybeans futures advanced as the market reacted to the Chicago Board of Trade today but closed slightly under the top under some late profit taking...

Table of grain prices including 'WHEAT', 'RYE', and 'BARLEY' with prices and changes.

Business

By JOHN CURRIFF AP Business Analyst NEW YORK (AP) — The troubled state of American urban society, and the fears of the business community...

NEW YORK (AP) — The troubled state of American urban society, and the fears of the business community... "No business, including the property insurance business," said T. Lawrence Jones...

Successful Investing

By ROGER E. SPEAR Q. A few years back I was given some first hand knowledge of what it is generally poor to invest in. I was given some first hand knowledge of what it is generally poor to invest in...

S.P.M. QUOTATIONS

Table of S.P.M. quotations for various commodities like 'WHEAT', 'RYE', 'BARLEY', 'CORN', and 'SOYBEANS'.

Over the Counter

Table of over-the-counter market data including 'GRAIN', 'LIVESTOCK', and 'POTATOES'.

Denver

DENVER (AP) (USD)—Cattle 50c higher; hogs 10c higher; sheep 10c higher...

Omaha

OMAHA (AP) (USD)—Hogs 5.00; barrows and gilts 2.50 to 2.50 higher...

Chicago

CHICAGO (AP) (USD)—Hogs 3.50; 12 190-240 lb butchers 19.50-20.50...

Cash Grain

CHICAGO (AP) — Wheat No. 1 hard 1.32 1/2 to 1.33 1/2... No. 2 white 1.26 1/2 to 1.27 1/2...

Cattle Futures

CHICAGO (AP) (USD)—Cattle futures: high clover 1.00 to 1.05... mixed high choice 1.00 to 1.05...

Grain Futures

CHICAGO (AP) — Wheat No. 1 hard 1.32 1/2 to 1.33 1/2... No. 2 white 1.26 1/2 to 1.27 1/2...

Potatoes-Onions

CHICAGO (AP) (USD)—Potatoes arrivals: 80c on truck... Onions: 1.25 to 1.30...

Mutual Funds

Affiliated Fund ... 8.56 9.26 Commonwealth ... 20.27 21.00... Eaton & Howard ... 20.27 21.00...

Sugar

NEW YORK (AP)—Domestic sugar: raw sugar 13 1/2 cents... Raw sugar 13 1/2 cents...

Futures

The following quotations were provided by E. W. McRoberts and Co., Inc. in Minneapolis, Minn.

Over the Counter

Albertson's ... \$14.00 \$14.75... Equify Oil ... \$19.00 20.00...

Portland

PORTLAND (AP) — April 17 close Portland Grain Exchange: Wheat (bid) to arrive market...

Kansas City

KANSAS CITY (AP) — Wheat 1 1/2c higher; hogs 10c higher; sheep 10c higher...

Omaha

OMAHA (AP) (USD)—Hogs 5.00; barrows and gilts 2.50 to 2.50 higher...

Chicago

CHICAGO (AP) (USD)—Hogs 3.50; 12 190-240 lb butchers 19.50-20.50...

Cash Grain

CHICAGO (AP) — Wheat No. 1 hard 1.32 1/2 to 1.33 1/2... No. 2 white 1.26 1/2 to 1.27 1/2...

Cattle Futures

CHICAGO (AP) (USD)—Cattle futures: high clover 1.00 to 1.05... mixed high choice 1.00 to 1.05...

Grain Futures

CHICAGO (AP) — Wheat No. 1 hard 1.32 1/2 to 1.33 1/2... No. 2 white 1.26 1/2 to 1.27 1/2...

Potatoes-Onions

CHICAGO (AP) (USD)—Potatoes arrivals: 80c on truck... Onions: 1.25 to 1.30...

Mutual Funds

Affiliated Fund ... 8.56 9.26 Commonwealth ... 20.27 21.00... Eaton & Howard ... 20.27 21.00...

Sugar

NEW YORK (AP)—Domestic sugar: raw sugar 13 1/2 cents... Raw sugar 13 1/2 cents...

Futures

The following quotations were provided by E. W. McRoberts and Co., Inc. in Minneapolis, Minn.

Over the Counter

Albertson's ... \$14.00 \$14.75... Equify Oil ... \$19.00 20.00...

Editor Unit Raps Administration

WASHINGTON (AP)—A committee of the American Society of Newspaper Editors has rapped the administration for its handling of the Vietnam war...

Butter and Eggs

CHICAGO (AP)—Butter and eggs: wholesale buying prices unchanged; 80 percent of butter...

New Ambassador

NEW YORK (AP)—Wood-Tuff's new ambassador to the Philippines is William McCormick Blair Jr., who resigned...

To Draft Women

TEHRAN (AP)—Iran plans to draft women in the 15-25 age brackets for two-year service...

ANNOUNCING:

We are in the process of remodeling, but we are still open for business. Ice Cream • Punch • Mints • Home Made Candy

FREDERICKSON'S

309 2nd St. East 733-7624

ACTION THE AUCTION WAY!

REGULAR SALE APRIL 19 100 HEAD STEER AND HEIFER CALVES 100 HEAD STEER CALVES WEIGHING 500 LBS.

GOODING LIVESTOCK COMMISSION CO.

in the heart of the good grass country on the U.P. Malheur where you find the largest selection of top quality stocker & feeder cattle in the Northwest

This is in addition to our regular run

2 1/2 lbs. cents a pound, East of 120 lbs. a pound, New York

Time 1 1/4 a pound, New York

Gold 2.25 per Troy ounce, New York

Silver 2.80 per Troy ounce, New York

Quicksilver \$50.00 nominal per flask, New York

SPORTS

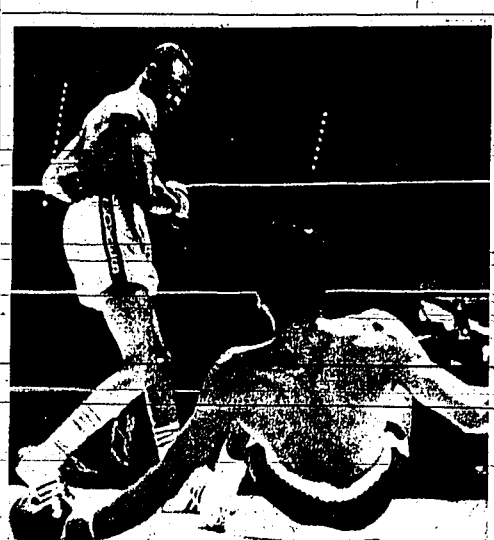

WILLIE LUDICK of South Africa hits the canvas after welterweight Champion Curtis Cokes of Dallas downed him with a thunderous right in the fifth round of their fight in Dallas Tuesday night. Ludick regained his feet but referee Lew Eskine halted the fight after Cokes continued to batter Ludick around the ring. (AP wirephoto)

READ TIMES-NEWS WANT ADS

Kimberly Fills Two Coaching Jobs

Under Research, Kimberly was second in the state A-B basketball tournament a year ago and reached the championship semifinals this spring, losing by one point in overtime to eventual champion, JIM Academy.

Standings

By The Associated Press National League	
St. Louis	W. L. Per. G.B.
St. Louis	5 1 .833 1
Pittsburgh	3 2 .600 1 1/2
San Francisco	3 2 .600 1 1/2
Los Angeles	3 3 .500 2
Chicago	3 3 .500 2
New York	2 4 .333 2 1/2
Cincinnati	2 4 .333 2 1/2
Atlanta	1 6 .143 4 1/2

American League	
Minneapolis	W. L. Per. G.B.
Minneapolis	5 0 1.000 1
Cleveland	3 2 .600 2
Oakland	3 2 .600 2
Baltimore	3 2 .600 2
Boston	3 3 .500 2 1/2
California	3 3 .500 2 1/2
Washington	3 3 .500 2 1/2
New York	1 1 .500 4
Chicago	0 4 .000 4 1/2

S. Haynie Leads Money Winners

CINCINNATI (AP) — Sandra Haynie has won a Women's Golf tournament yet in 1968. But close finishes have boosted her into the lead in money winners on the Ladies Professional Golf Association tour, LPGA headquarters announced today.

Want to Rent Something?

Use Classifieds

Classifications

70 through 89

Granatelli Enters 6 Turbines In '500'

By DALE-BURGESS INDIANAPOLIS, Ind. (AP) — The Granatelli turbine cars, stripped of some muscle by a U.S. District Court decision, will be in the Indianapolis 500-mile race anyway.

Joseph's Paxton Products is a member of the Sudebaker.

INVITATION FOR BIDS

1968 FARMING PRIVILEGES DEPARTMENT LANDS

Notice is hereby given that the Idaho Fish and Game Department will accept bids for farming privileges on approximately 30 acres of irrigated farmland lying within the Silver Creek access area, more particularly described on the SE 1/4 NW 1/4 NE 1/4, Section 20, Township 1 South, Range 20 East, Boise Meridian, from April 25 to December 31, 1968.

Cokes Stops Ludick With TKO In Fifth Round To Keep Welterweight Title

By HAROLD V. RATLIFF DALLAS, Tex. (AP) — Curtis Cokes battered Willie Ludick to bloody defeat with a two-handed attack that left the South African out on his feet in the fifth round Tuesday night as he defended his world's welterweight title.

Track Meet

Jerome and Wood River will have invitational and Gooding State will host the Northwest Conference teams Tuesday night at the area meet.

Packers Swap Two Men For Giants' Peay

GREEN BAY, Wis. (AP) — The National Football League champion Green Bay Packers traded offensive tackle Dave Wright and linebacker Tommy Crutcher to the New York Giants Tuesday for offensive tackle Francis Peay.

Mets, Astros Happy About Day Of Rest

HOUSTON, Tex. (AP) — The New York Mets and the Houston Astros of the National League were thankful Tuesday was a scheduled day off.

TV Chukars Sweep Pair From CSI

Treasure Valley swept a doubleheader from Columbia Valley Saturday Idaho 4-0 and 8-2 Tuesday while Hampton and Stonebreaker went the route for the victories.

Red Sox Haul In Awards At Opening

BOSTON (AP) — Manager Dick Williams and three members of his 1967 champion Boston Red Sox collected awards Tuesday after the American League pennant was raised on the flag pole in left-center for the first time in 21 years.

Huskies Put Trainer On Probation

SEATTLE, Wash. (AP) — Athletic Director Jim Owens said Tuesday he has put on probation, pending the formation of an advisory committee and is arranging for a Negro coach in an effort to improve relations between his staff and the University of Washington's black athletes.

Vandal Came To Be Televised

MOSCOW, Idaho (AP) — The University of Idaho's homecoming football game will be televised regionally Oct. 12. It will be the first stadium clash between the Idaho Vandals and the University of Montana.

Fish Movement

The upstream movement of fish at Columbia River dams April 15:

Skyline Takes Two From Minico

IDAHO FALLS (AP) — FALC's line's Kenny Barrow fanned 13 batters in a seven inning no-hitter and a series of singles in the third game of the third game of the Grizzlies 5-0 and 9-6 doubleheader wins over the Minico Spartans.

WE BUY, SELL & TRADE GUNS

RED'S Trading Post

KING COAL

WARBERG'S 733-7371 for Quality

SALE 3 DAYS ONLY

GOOD YEAR MARATHON TIRE

4 ply nylon cord

EXTRA MILEAGE TREAD RUBBER

8000 GRIPPING EDGES

MODERN WRAP-AROUND TREAD

Our newest and finest economy-priced tire, now offers you — added safety plus extra-mileage at this low, low price...

\$13.50

SIZE	WAS	IS	Plus F.E.T. & old tire
6.50x13	\$15.00	\$13.50	\$1.81
7.75x14	\$17.15	\$15.44	14 - \$2.19
7.75x15			15 - \$2.21
8.25x14	\$19.45	\$17.50	14 - \$2.35
8.5x15			15 - \$2.35
8.5x14	\$21.60	\$19.44	14 - \$2.56
8.5x15			15 - \$2.54
8.85/9.00x15	\$26.05	\$23.44	\$2.81



DICK DeHART

A partner in Gateway, Dick DeHart is in charge of sales and public relations. He has seen the Gateway Trailer Center grow from a lot with a few trailers to the large operation it is today.



Dean Fenstermaker

The other partner in Gateway, Dean is in complete charge of service and maintenance. Therefore when you buy a new or used travel-trailer-pickup-camper or mobile home you know that it is in tip-top shape.

OPEN HOUSE

IDAHO'S LARGEST

Idaho's Largest Dealer Of

Mobile Homes & Travel Trailers

Cordially Invites You

To Their 4th Annual

OPEN HOUSE

FRIDAY - SATURDAY - SUNDAY

9 am to 6 pm

EACH DAY

Meet Our Staff

free LIBBY'S CANNED GOODS

One full case of Libby's canned goods will be given every hour of our OPEN HOUSE CELEBRATION beginning at 10 a.m. and ending at 5 p.m. on Friday, Saturday, and Sunday.

GRAND-OPENING-SUNDAY AT 5 P.M.

10 cases of Libby's canned goods will be given to some lucky person at this drawing.

WINNER NEED NOT BE PRESENT TO WIN.

Extra Savings

USED TRAILERS & CAMPERS
ALSO MOBILE HOMES

Units that folks have traded in on newer models. All in fine shape and discounted for the three days of our open house.

OVER 90 IN STOCK

You will find them a pleasant group to know. Our only purpose in selling is to make sure you have just what you want, and that it is serviced as it should be.

Bigger Values!

CHOOSE FROM THE FINEST

MOBILE HOMES • MARLETTE • TAMARACK
• MAGNOLIA

TRAVEL TRAILERS • ROADRUNNERS
• ARISTOCRAT • TRAVELEZE

PICKUP CAMPERS • MEL-MAR • BEAVER
• NAMPA CHIEF

ALSO THE WINNEBAGO MOTOR HOMES

PICK UP COVERS

Utility covers to make your pickup into a camper or make sure your load is protected from the weather.

CAMPERS

For the sportsman and his family. Go fishing, hunting or skiing. No problems because you have your own quarters for sleeping, eating and warmth.

TRAVEL TRAILERS

You never have to worry about motels or hotels. You have everything you want with you. You save money, too.

MOBILE HOMES

Becoming more popular every day. Just like buying a completely furnished home, except that you pay thousands of dollars less. Put it on your own lot or park in a modern park. Retired couples are finding a mobile home the answer to many of their needs.

ATTENTION MOBILE HOME OWNERS!

REGISTER BEFORE 5 P.M. SUNDAY, APRIL 21

For Two Sets of Deluxe MOBILE HOME STEPS

Winners Need Not Be Present!

Gateway Trailer Center has a complete selection of pickup campers, travel trailers, motor homes and mobile homes. We can fill any need or desire you may have.

ALL-ELECTRIC MODELS ARE ALSO AVAILABLE

You get lower electric rates in one of these homes.

WHAT A WONDERFUL WAY TO GO

Set your own pace when you travel — you have your own home with you if you decide to stop — or you have a gorgeous residence in which to live.

Special Markdowns!

ROADRUNNER 12-FT. TRAVEL TRAILER

- Sleeps four
- 3-burner deluxe gas range
- Sink and pump, 24-gal. water storage
- Electric and gas lighting
- double walls and floors
- Completely fiberglass insulated
- All natural wood interiors.

MARKED DOWN FOR 3 DAYS

ONLY \$920⁰⁰

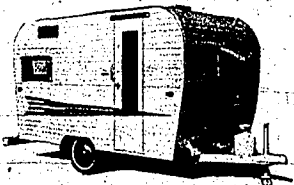

OPEN EVENINGS BY APPOINTMENT

GATEWAY TRAILER CENTER

IDAHO'S LARGEST DISPLAY OF MOBILE HOMES

BLAKE AT ADDISON AVE. W., TWIN FALLS

Happiness Is--Homemade Breads

Ever notice how folks brighten at the sight and aroma of freshly baked breads? It doesn't matter whether these golden loaves are brought out to partner a spring salad or breakfast eggs, to sweeten a tea table array of acid substance to a gardener's lemonade break--hot breads create a happy mood. If you ordinarily consider such delicious nibbling fare too difficult to prepare, read on.

There is really nothing quite so simple to fix, nor so satisfying to serve as a quick bread like this rich Cheddar-Apple loaf. It's almost fool-proof, desired for the new cook and the experienced one as well. That favorite flavor duo for pies, . . . apple and cheese -- has been used in the bread. Canned apple pie filling is beaten into a fluff of shortening and sugar.

The apple filling can be used just as it comes from the can, orchard-fresh and delicately seasoned. The dry ingredients are stirred in and the Cheddar cheese and chopped nuts added and quickly mixed before baking. The apple pie filling helps to make this a wonderfully moist bread, while the flecks of Cheddar add a attractiveness you'll find most appealing.

This is the kind of bread that can be served for breakfast. It's really a bread and a cake all in one. Cut into he-man portions, it would be a dandy entertainment for a steaming chowder. Or it would go equally well, served with a Cheddar cheese spread, as a quick snack with mugs of coffee.

Daintier slices will find a place on party tables for the ladies, served as is or topped with a puff of whipped cream, chest or soft-top margarine. No matter when you serve this delicious bread, be sure it's warm, for the flavor is better when it's hot.

- CHEDDAR APPLE BREAD**
- 1/2 cup shortening
 - 1/2 cup sugar
 - 1 No. 2 can (2 cups) apple pie filling
 - 2 1/2 cups sifted flour
 - 1 teaspoon salt
 - 1 teaspoon baking powder
 - 1/2 cup chopped walnuts or pecans
 - 1/2 cup cream shortening and sugar; add egg. Beat in apple pie filling. Sift together flour, salt, soda, and baking powder. Add sifted dry ingredients, nuts and nuts to batter. Mix quickly. Pour into well-greased 9x5-inch loaf pan. Bake at 350 degrees for one and one-half hours. Makes one loaf.

Women's Golf Association Has Luncheon

BUHL—The Buhl Women's Golf Association held its first luncheon meeting on the season at the Club House, with luncheon served at noon with Mrs. Robert W. Hager, chairman.

Spring flowers were arranged on the serving table by Mrs. Charles Boring.

Members and guests were welcomed by Mrs. Harry Wilson, club president. She appointed Mrs. Edward Novack to serve on the food committee for the year.

The date for the Buhl Women's Golf Association Invitational is set for Aug. 1.

Mrs. David Munro was elected to represent the association at the Best Cook contest.

Mrs. Warren Saunders, secretary -- treasure, read invitations from Hillcrest, Boise, Blackfoot, Pinescrest at Idaho Falls, the Idaho State Women's Amateur at Crane Creek in Boise, Rupert on June 4 and the Magic Valley Open on June 20 and 21 at Jerome.

Mrs. Wilson urged all women who want to qualify for the Best Ball Tournament to do so in the near future, as qualification must be completed by the end of next week.

Twenty-eight women played in the opening game, with Mrs. Wayne Aland receiving the ball for low score and the teens for the least amount of puts. Mrs. Saunders received the ball for special prize.

The women will play each Thursday, teeing off at 1 p.m. Beginners were given instructions in a clinic by Frank Stewart, local pro.

WE DARE YOU TO COMPARE DIAMOND PRICES!

OUR 1/2 CARAT FINE COLOR, FINE CUT

Our Price \$495.00

Compare with rings selling for \$795.00

CREDIT TERMS: NO INTEREST

Summerfield (Next to Yellow Cab)

SHOSHONE at MAIN



FRESHLY BAKED BREAD is indeed a treat for all families and really very simple to prepare. The **CHEDDAR APPLE** loaf is almost fool-proof and is designed for the new cook and the experienced one as well.

Social Calendar

The Baptist Women's Mission Society of the First Baptist Church will meet at 1:30 p.m. Thursday in the chapel. Officers will be installed, special music, presented and love gift. Thomas Allen Circle is the hostess group.

Emanuel Club will meet at 2 p.m. Friday at the home of Mrs. E. L. Rayburn. Fay Sharp is in charge of the program.

SHOSHONE—Baptist Women's Mission will meet at 8 p.m. Thursday at the home of Mrs. Howard Rukins. Mrs. B. Hughes is speaker.

District Meet In Rupert Set For Thursday

RUPERT—About 50 members of the South Central District No. 4, Episcopalian Synod, will gather at the Drift Inn in Rupert Thursday evening for the annual district meeting.

Those attending will represent the Twin Falls, Burley and Rupert chapters of the sorority, and special guests will be Joyce Presby, state president, and her sister, Mrs. Bea Crescenpo, both Boise.

District business during the banquet will include the election and installation of officers for the coming year.

Plans for the event were discussed during the regular meeting of the Alpha Eta Chapter in Rupert recently.

During the meeting of the local chapter, officers were elected. They include Mrs. Dick Irwin, president; Mrs. Guy Neel-erside, majoring in English.

Mrs. Baird was graduated from the University of California at Riverside in March, 1958, with a major in physics. He is employed at the Naval Weapons Center, Corona Laboratories, Corona, Calif.

John Baird Set Garden-Wedding

GLENN'S FERRY—Mr. and Mrs. Robert W. Hager, San Dimas, Calif., announce the engagement and forthcoming marriage of their daughter, Jill Gooding High School and from Elham Hager, to John M. Baird, son of Mr. and Mrs. Melvin Baird, Gooding.

The garden wedding is planned at the Hager home April 20.

Miss Hager graduated from Bonita High School, LaVerne, Calif., and is now attending the University of California at Riverside.

Social Calendar

man, vice president; Mrs. Norman Hutton, recording secretary; Mrs. Domingo Equilator, corresponding secretary; Mrs. Norman Skeen, treasurer, and Mrs. John Simpson, program director.

Local Miss, Permann Wed In Temple Rites

Carol Christensen, daughter of Mr. and Mrs. W. R. Christensen, Twin Falls, became the bride of Steven Permann, son of Mr. and Mrs. Harold Permann, Rockland, at a ceremony performed March 22 in the Idaho Falls LDS Temple.

A reception was held at the Carillon in Twin Falls. The bride wore a "Bridal Original" gown of scalloped, chrysanthemum-patterned Chantilly lace, enhanced with removable scalloped chapel train and long lily-point sleeves, taupe on the wrists with self-covered tiny miniature buttons. Her elbow-length veil of English silk illusion was held in place by organdy and lace petals.

She carried a cascade bouquet of pink Sensation and Better Times roses with leather leaf accents, backed with pink and Better Times velvet ribbon.

Bridesmaids were Gertrude Stout, cousin of the bride, Boise; Jana Permann, sister of the bridegroom; Rockland; and Barbara Christensen and Joyce Christensen, sisters of the bride, Twin Falls. Matron of honor was Mrs. Sherry Call, sister of the bride, Provo, Utah.

Mr. Permann, brother of the bridegroom, served as best man, with John Freeman, cousin of the bridegroom, and Jim Wordworth, brother-in-law of the bridegroom, serving as ushers.

Gwen Call presided at the guest book table which was skirted in a ruffled lace cloth accented with a chrysanthemum and gold beads and sequins. Mary Pat O'Connor was in charge of the gift table. The wedding party received guests in the main hall of the Carillon before a background of white flannel velvet accented with satin bells and ribbon streamers.

The bride's table was enhanced with a white tulle three-tiered skirt topped with white satin draped in ribbons of light pink and hot pink circles and bows.

The table was centered with a four-tiered clover leaf-shaped wedding cake decorated with pink roses and double ribbons and topped with white, satin bells. Quartet tables were covered with white nylon lace over pink

Women's Section



MR. AND MRS. STEVE PERMANN (Southern Idaho Photography)

and centered with light pink tulle around sinners which held clusters of pink satin roses. Pink and white topiary trees were placed throughout the room.

Mrs. David Mendel was soloist during the reception and background music was provided by Mrs. Edna Pack.

Refreshments were served by Mrs. Lyman Christensen, Mrs. Colabelina Mrs. Ver Cox and Mrs. Arthur Clark.

The couple resided in Provo, where the bridegroom attends Brigham Young University.

Out-of-town guests attended from Logan and Salt Lake City, Utah, Rockland and American Falls, Boise and Nampa.

Ladies Of Elks Host Banquet

JEROME—Members of the Ladies of Elks held their Past Presidents Banquet and installation of officers recently at the Elks Lodge.

Gilbert Tilley, exalted ruler, installed the officers, assisted by Bob Meyer, acting chaplain.

New officers to begin their duties in September are: Mrs. Ted Bruckner, president; Mrs. Lovins Smith, vice president; Mrs. Bill Trujillo, secretary, and Mrs. Darwin Sulsten, treasurer.

Let the Profile Bread Plan help prolong your Slender Years.



WOOLWORTH'S NYLON SALE

Phinrose

Two smooth-fitting types

SEAMLESS NYLONS 77¢

Stock up now on perfect-fit Calnece® or Agilon® stretch. In rosestone, sunstone or taupe/stone. Proportioned to fit sizes 84-114.

YOUR MONEY'S WORTH MORE AT WOOLWORTH'S

Penney's REDUCED thru SAT!

ALWAYS FIRST QUALITY

Save on girls' shells, slacks and Jamcoats during our GREAT

SPORTSWEAR CARNIVAL

3 to 6x Orig. \$1.98 NOW 2 F \$3 O R	7 to 14 Orig. \$2.98 NOW 2 F \$5 O R
3 to 6x Orig. \$1.59 NOW 2 F \$3 O R	4 to 6x Orig. \$2.98 NOW 2 F \$4 O R

Girls' Penn-Prest® denim slacks
Girls' never-iron pant tops!

Slacks are a rugged blend of cotton and stretch nylon denim Firm-fit to machine wash, dry or tumble dry, never need ironing.
7 to 14, Orig. 2.98, NOW 2 for \$5

Patterns and styles "shells" in "style-creak" polyester/Aurora rayon, Penn-Prest® to you just wash, tumble dry, wear.

Cotton and stretch nylon denim Penn-Prest® to machine wash, dry or tumble dry never, never need ironing. Pick up plenty.
7 to 14, Orig. 1.98, NOW 2 for \$3

Patterns and styles "shells" in "style-creak" polyester/Aurora rayon, Penn-Prest® to you just wash, tumble dry, wear.

Few colors to mix or match! Choose cream, loaf or pink styles In machine washable Auron® nylon. Stock up for now.
7 to 14, Orig. 2.98, NOW 2 for \$5

CHARGE IT AT PENNEY'S, TWIN FALLS

Vans

FASHION in the ABSTRACT

The Jones Girl

An abstract print goes wild on Summer-New season . . . skillfully fashioned in the shift silhouette that's as comfortable as it is attention-getting. Black and White. Sizes 10-18.

\$12.00

MBS SECURITY BANKAMERICAN

Walker Bank and

Vans DEPARTMENT STORE IN THE LYNWOOD



DICK DeHART

A partner in Gateway, Dick DeHart is in charge of sales and public relations. He has seen the Gateway Trailer Center grow from a lot with a few trailers to the large operation it is today.



Dean Fenstermaker

The other partner in Gateway, Dean is in complete charge of service and maintenance. Therefore when you buy a new or used travel trailer, pickup camper or mobile home you know that it is in tip-top shape.

OPEN HOUSE

IDAHO'S LARGEST

HOUSE

Idaho's Largest Dealer Of
Mobile Homes & Travel Trailers
 Cordially Invites You
 To Their 4th Annual
OPEN HOUSE

FRIDAY - SATURDAY - SUNDAY

9 am to 6 pm
 EACH DAY
Meet Our Staff

free LIBBY'S CANNED GOODS

One full case of Libby's canned goods will be given every hour of our OPEN HOUSE CELEBRATION beginning at 10 a.m. and ending at 5 p.m. on Friday, Saturday and Sunday!

GRAND OPENING SUNDAY AT 5 P.M.

10 cases of Libby's canned goods will be given to some lucky person at this drawing.

WINNER NEED NOT BE PRESENT TO WIN

Extra Savings

USED TRAILERS & CAMPERS
 ALSO MOBILE HOMES

Units that folks have traded in on newer models. All in fine shape and discounted for the three days of our open house.

OVER 90 IN STOCK

You will find them a pleasant group to know. Our only purpose in selling is to make sure you have just what you want, and that it is serviced as it should be.

Bigger Values!

CHOOSE FROM THE FINEST

MOBILE HOMES • MARLETTE • TAMARACK
 TRAVEL TRAILERS • MAGNOLIA • ROADRUNNERS
 PICKUP CAMPERS • ARISTOCRAT • TRAVELEZE
 • MEL-MAR • BEAVER
 • NAMPA CHIEF

ALSO THE WINNEBAGO MOTOR HOMES

PICK UP COVERS

Utility covers to make your pickup into a camper or make sure your load is protected from the weather.

CAMPERS

For the sportsman and his family. Go fishing, hunting or skiing. No problems because you have your own quarters for sleeping, eating and warmth.

TRAVEL TRAILERS

You never have to worry about motels or hotels. You have everything you want with you. You save money, too.

ATTENTION MOBILE HOME OWNERS!

REGISTER BEFORE 5 P.M. SUNDAY, APRIL 21

For Two Sets of Deluxe MOBILE HOME STEPS

Winners Need Not Be Present!

Gateway Trailer Center has a complete selection of pickup campers, travel trailers, motor homes and mobile homes. We can fill any need or desire you may have.

MOBILE HOMES

Becoming more popular every day. Just like buying a completely furnished home, except that you pay thousands of dollars less. Put it on your own lot or park in a modern park. Retired couples are finding a mobile home the answer to many of their needs.

ALL-ELECTRIC MODELS ARE ALSO AVAILABLE

You get lower electric rates in one of these homes.

WHAT A WONDERFUL WAY TO GO

Set your own pace when you travel — you have your own home with you if you decide to stop — or you have a gorgeous residence in which to live.

Special Markdowns!

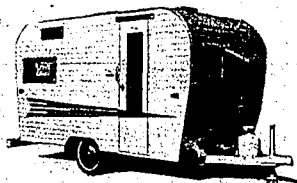

ROADRUNNER 12-FT. TRAVEL TRAILER

- Sleeps four
- 3-burner deluxe gas range
- Sink and pump, 24-gal. water storage
- Electric and gas lighting
- Completely fiberglass insulated
- double walls and floors
- All natural wood interiors.

MARKED DOWN FOR 3 DAYS

ONLY \$920⁰⁰

OPEN EVENINGS
 BY APPOINTMENT

GATEWAY TRAILER CENTER

IDAHO'S LARGEST DISPLAY OF MOBILE HOMES

BLAKE AT ADDISON AVE. W., TWIN FALLS

Happiness Is---Homemade Breads

Ever notice how folks brighten at the sight and aroma of freshly baked breads? It doesn't matter whether these golden loaves are brought out to partner a spring salad or breakfast eggs, to sweeten a tea table array or add substance to a gardener's lemonade break--hot breads create a happy mood. If you ordinarily consider such delicious ribbiting fare too difficult to prepare, read on.

There is really nothing quite so simple to fix, nor so satisfying to serve as a quick bread like this rich Cheddar Apple loaf. It's almost fail-proof, designed for the new cook and the experienced one as well. That favorite flavor duo for pies--apple and cheese--has been used in the bread. Canned apple pie filling is beaten into a fluff of shortening and sugar.

The apple fillings can be used just as it comes from the can, or fresh and delicately seasoned. The dry ingredients are stirred in and the Cheddar cheese and chopped nuts added and quickly mixed before baking. The apple-pie-filling helps to make this a wonderfully moist bread, while the chunks of Cheddar add a sharpness you'll find most appealing.



FRESHLY BAKED BREAD is indeed a treat for all families and really very simple to prepare. The Cheddar Apple Loaf is almost fail-proof and is designed for the new cook and the experienced one as well.

Social Calendar

District Meet In Rupert Set For Thursday

The Baptist Women's Mission Society of the First Baptist Church will meet at 1:30 p.m. Thursday in the chapel. Officers will be installed, special music presented and love gift, Thelma Allen Circle is the hostess group.

Emmanuel Club will meet at 2 p.m. Friday at the home of Mrs. Royburn. Fay Sharp is in charge of the program.

THIRDSOME Baptist Women's Mission will meet at 8 p.m. Thursday at the home of Mrs. Howard Adams. Mrs. B. Hughes is speaker.

Jill E. Hager, John Baird Set Garden Wedding

GLENN'S FERRY -- Mr. and Mrs. Robert W. Hager, San Dimas, Calif., announce the engagement and forthcoming nuptials of their daughter, Jill E. Hager, to John M. Baird, Riverside in March, 1958.

A garden wedding is planned at the Hager home April 20. Miss Hager graduated from Bonita High School, LaVerne, Calif., and is now attending the University of California at Riverside.

man, vice president; Mrs. Norman Hutton, recording secretary; Mrs. John Simpson, corresponding secretary; Mrs. Norman Simpson, program director.

Those attending will represent the Twin Falls, Burley and Rupert chapters of the sorority, and special guests will be Joyce Presby, state president, and her sister, Mrs. Bea Creveson, both Boise.

District business during the banquet will include the election and installation of officers for the coming year.

Plans for the event were discussed during the regular meeting of the chapter--Eta-Chapeta in Rupert recently.

During the meeting of the local chapter, officers were elected. They include Mrs. Dick Irwin, president; Mrs. Guy Meule-aside majoring in English.

Mr. Baird was graduated from the University of California at Riverside in March, 1958, with a major in physics. He is employed at the Naval Weapons Center, Corona Laboratories, Corona, Calif.

WOOLWORTH'S NYLON SALE

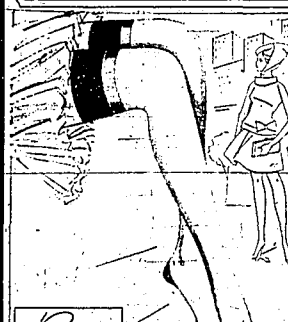

Two smooth-fitting types SEAMLESS NYLONS

Stock up now on perfect-fit Cantreco® or Agilon® stretch. In rosestone, sunstone or taupestone. Antipositioned to fit sizes 8-14.

77¢ Reg. 98¢ pr.

YOUR MONEY'S WORTH MORE AT WOOLWORTH'S

Women's Golf Association Has Luncheon

Buhl -- The Buhl Women's Golf Association held its first luncheon meeting of the season at the club Tuesday. Lunch was served at noon with Mrs. Robert Weaver, chairman.

Spring flowers were arranged on the serving table by Mrs. Charles Doring.

Members and guests were welcomed by Mrs. Harold Wilson, club president. She appointed Mrs. Edward Novack to serve as the food committee for the year.

The date for the Buhl Women's Golf Association "Invitation Dinner" for 1958 is Tuesday, Mrs. David Munroe was elected to represent the association at the Best Cook contest.

Mrs. Warren Saunders, secretary - treasurer, read invitations from Hillcrest, Boise Blackfoot, Placerest at Idaho Falls, the Idaho State Women's Amateur at Crane Creek in Boise, Rupert on June 4 and the Magic Valley Open on June 20 and 21 at Jerome.

Mrs. Wilson urged all women who want to qualify for the Best Ball Tournament to do so in the near future as qualifying must be completed by the end of next week.

Twenty-eight women played in the opening game with Mrs. Wayne Aland receiving the ball for low score and the fees for the least amount of putts. Mrs. Saunders received the ball for special prize.

The women will play each Thursday, teeing off at 1 p.m. Beginners were given instructions in a clinic by Frank Stewart, local pro.

WE DARE YOU TO COMPARE DIAMOND PRICES!

OVER 1/2 CARAT FINE CUT OUR PRICE \$495.00

Compare with rings selling for \$795.00

CREDIT TERMS NO INTEREST

Summitfield B/B

SHOWROOM AT MAIN (Just to Yellow Cab)

Local Miss, Permamm Wed In Temple Rites

Carol Christensen, daughter of Mr. and Mrs. W. R. Christensen, Twin Falls, became the bride of Steve Permamm, son of Mr. and Mrs. Harold Permamm, Blackland, at a ceremony performed March 22 in the Idaho Falls LDS Temple.

A reception was held at the Carillon in Twin Falls. The bride wore a "Bridal-Original" gown of scalloped chrysanthemum-patterned Chantilly lace, enhanced with removable scalloped chapel train and long fifty-point sleeves, caught at the wrists with self-covered tiny miniature buttons. Her elbow-length veil of English silk illusion was held in place by organza and lace petals.

She carried a cascade bouquet of pink Sensation and Better Times roses with leather leaf accents, backed with pink and Better Times velvet ribbon.

Bridesmaids were Gertrude Stout, cousin of the bride, Boise; Jana Permamm, sister of the bridegroom, Rockland; and Barbara Christensen and Joyce Christensen, sisters of the bride, Twin Falls. Matron of honor was Mrs. Sherry Call, sister of the bride, Bronco, Idaho.

Merrill Permamm, brother of the bridegroom, served as best man, with John Freeman, cousin of the bridegroom, and Jim Woodworth, brother-in-law of the bridegroom, serving as ushers.

Given Call presided at the guest book table which was skirted in a ruffled lace cloth accented with a cherub fountain and gold beads and sequins.

Mary Pat O'Connor was in charge of the gift table. The wedding party received guests in the main hall of the Carillon before a background of white flocked velvet accented with satin bells and ribbon streamers.

The bride's table was enhanced with a white tulle three-tiered skirt topped with white satin draped in ribbons of light pink and hot pink circles and bows. The table was centered with a four-tiered clover leaf-shaped "curtain" centerpiece with pink roses and double hearts, and topped with white satin bells.

Women's Section

Ladies Of Elks Host Banquet

JEROME -- Members of the Ladies of Elks held their first Presidents Banquet and Installation of officers recently at the Elks Lodge.

Gilbert Tilley, exalted ruler installed the officers, assisted by Bob Myer, acting chaplain.

New officers to begin their duties in September are Mrs. Ted Buckner, president; Mrs. Lynn Smith, vice president; Mrs. Bill Trujillo, secretary, and Mrs. Darwin Shulsen, treasurer.



MR. AND MRS. STEVE PERMAMM (Southern Idaho Photograph)

The table was centered with light pink tulle around sinners which held clusters of pink satin roses, pink and white topary trees were placed throughout the room.

Mrs. David Mead was soloist during the reception and background music was provided by Mrs. Edna Peck.

Refreshments were served by Mrs. Lyman Christensen, Mrs. Lou Soboschal, Mrs. Ver Cox and Mrs. Arthur Clark.

The couple resided in Provo, where the bridegroom attends Brigham Young University.

Courtesy guests included from Logan and Salt Lake City, Utah, Rockland, American Falls, Boise and Nampa.

Let the Profile Bread Plan help prolong your Slender Years.

USE TIMES-NEWS WANT ADS FOR FAST-SELLING RESULTS

Penney's REDUCED thru SAT.!

ALWAYS FIRST QUALITY

Save on girls' shells, slacks and Jambalos during our GREAT

SPORTSWEAR CARNIVAL

3 to 6x Orig. \$1.98 NOW	2 F 3 R	7 to 14 Orig. \$2.98 NOW	2 F 5 R
Girls' Penn-Prest® denim slacks!		Girls' never-iron pant legs!	
Slacks are a rugged blend of cotton and stretch nylon denim... Penn-Prest® is machine washable, dries or tumble dry, never need ironing.		Patterns and styles galore in easy-care polyester/Acrylic rayon, Penn-Prest®... to you just wash, tumble dry, wear.	
7 to 14, Orig. 2.98, NOW 2 for \$5			
3 to 6x Orig. \$1.59 NOW	2 F 3 R	4 to 6x Orig. \$2.98 NOW	2 F 4 R
Girls' Penn-Prest® denim Jambalos!		Girls' shell and headband sets!	
Cotton and stretch nylon denim... Penn-Prest® is machine wash, dry or tumble dry... never, never need ironing. Pick up slacks!		Pow colors to mix or match choice crew, boat or V-neck styles... in machine washable Antero® nylon. Stock up now!	
7 to 14, Orig. 1.98, NOW 2 for \$3		7 to 14, Orig. 2.98, NOW 2 for \$5	

CHARGE IT AT PENNEY'S, TWIN FALLS

Vans FASHION in the ABSTRACT

The Jones Girl

An abstract print goes wild on Summer-New satens... skillfully fashioned in the shift silhouette that's as comfortable as it is attention-getting. Black and White. Sizes 10-18.

\$12.00

FIRST SECURITY BANK/AMERICAN

Walker Bank/AMERICAN

Vans DEPARTMENT STORE IN THE LYNWOOD

Mrs. David Teeter Is Named For "Key Woman" Award

RUPERT — Mrs. David Teeter, state director, Rupert, is named "Key Woman of the Year" by Officers for the Jay-C-ettes. The Rupert Jay-C-ette Chapter, during a joint Jaycee-Jay-C-ette initiation program recently in Rupert.

Mrs. Teeter was honored for 165 hours of service to the local organization, and for serving eight chairmanships and three co-chairmanships. Also honored during the event was Mrs. Cary Mae, who was named Mrs. Constance and Mrs. Willing To Work.

Preceding the election of officers for the two clubs, Mal Ngo, Milico exchange student from Vietnam, spoke to the group of the customs of her native country.

Newly elected officers for the Jaycees are Cary Mae, president; Gary Allen, first vice president; Barry Bruner, second vice president; Dean Wilson, secretary; and Vaughn, treasurer; Larry Mettler, county director.



MRS. DAVID TEETER

Women's Club Hosts Breakfast

RUPERT — The annual Easter breakfast was held by the Cedar Grove Community Club, with Mrs. Kirby Pipal and son as hosts.

Each person who did not bake a pie for the John Bingham Park sale was asked to donate a pie to the Harrah Nursing Home.

Hostesses for the next meet- Home.

Women's Section

Magic Valley Favorites

MRS. BRUCE C. KUNKEL
Star Kaver, Twin Falls

- Delicious Oatmeal Biscuits
- 1/2 cup oil
- 1/2 cup oatmeal (quick cooking)
- 1/2 teaspoon salt
- 2 teaspoons sugar
- 1/2 teaspoon baking powder
- 1/2 teaspoon baking soda
- 1/2 tablespoons butter or margarine
- 1-3 cup buttermilk
- 2 eggs, beaten

This dry ingredients and cut in butter. Add and mix in buttermilk and eggs. Knead slightly on floured board. Roll out and cut into rounds. Place close together on baking sheet and bake in a 400 degree oven for 14 minutes or until lightly browned. Serve hot, buttered and spread with honey or jam.

ATTEND WEDDING
KING HILL — Mr. and Mrs. C. E. Spence attended the wedding of their grandson, Charles Max Long, Boise, and Sheila Marie Swigert, Caldwell, recently at the LDS Church in Caldwell. Mr. Long is the son of Mr. and Mrs. Charles Long of Twin Falls, and Miss Swigert is the daughter of Mr. and Mrs. Charles Swigert, Caldwell.

Area Couple Recites Vows

Buhl — Charlene Eggleston, daughter of Mr. and Mrs. Robert Eggleston, Buhl, became the bride of Gary Whiteley, son of Mr. and Mrs. Monroe Whiteley, Castleford, in a double-ring ceremony March 20 at the home of the bride's parents.

The evening ceremony was performed by Rev. Paul V. LaRue of the Buhl First Methodist Church before a festive bank of white chrysanthemums and carnations. The mantel was centered with three double crystal holders with blue tapers.

Given in marriage by her father, the bride wore a street-length gown of white wool, fashioned with a rounded neckline and long sleeves. The gown was made by the bride's mother. Her shoulder-length veil, which was borrowed from Mrs. Ralph Nelson, Twin Falls, consisted of three tiers of white tulle and a pearl train. She carried a colonial bouquet of white carnations and pink roses.

The bride was maid of honor and Mary Whiteley, Eggleston, Declo, and Mrs. Henry Eggleston, Buhl, both aunts of the bride.

Kathy Vittek was in charge of the gifts.

Wedding guests were present from Nebraska, Declo, Oakley, Castleford, Boise, Twin Falls and Kimberly.

After the ceremony, a reception was held at the Eggleston home, with Doris Eggleston, Declo, cousin of the bride, presiding over the guests.

The bride's table was covered with an ecru lace cloth over a blue and centered with a three-tiered wedding cake which was decorated and decorated by Leonard Walcott. The cake featured accents of blue and white topped with a miniature bride and groom. Blue and white flowers flanked the cake. Other appointments included a blue and white service and a crystal punch bowl.

Mrs. Eggleston and Mrs. Carlsson poured coffee and Mrs. Wilma Uetersy served the punch. The cake was cut and served by Mrs. George ER-

FREE!

Call Twin Falls WATER ANALYSIS 733-2421

We'll Check Your Water

SALE

WE BUY DIRECT FROM FACTORY

All of our hose & most of our sprinklers and we have LOWERED prices accordingly.

WALKING SPRINKLERS

Regularly \$26.95
NOW \$21.22

We stock all repair parts.

TRUE TEMPER

1/2" HOSE REEL AND UTILITY CART

Includes bracket, no outside hose reel can be mounted to house. Cart can be used in country, garden, fertilizer, etc. Accurate and safe.

\$13.89

TRUE TEMPER

6'2" LAWN RAKE

heavy duty
22" cutting blades
steel teeth
22" aluminum handle

\$2.99

WISS

HEDGE SHEARS

Perfectly balanced. Super cutting power requiring a minimum of effort. Sharp blades of most cutting steel, hardened and tempered. Round tapered natural grip handles.

Reg. 8.95
NOW \$5.88

DIAL-A-RAIN

SPRINKLER

REG. 14.95

SEE NEW VALUE

- UNIFORM COVERAGE
- 10 PRECISION CUT NOZZLES
- COVERS 3,000 SQ. FT.
- GUARANTEED 5 YEARS

\$10.88

Water Timer

For carefree watering control. Dial amount of watering needed... leaves timer running out water. Turns off sprinkler automatically. Gentle splash action. "Hold" position for continuous watering.

\$6.95

SHRUB & HEDGE TRIMMER

U-172

1 1/2" SHARP STEEL BLADES
1 1/2" SHARP STEEL BLADES
1 1/2" SHARP STEEL BLADES
1 1/2" SHARP STEEL BLADES

\$19.99

TORO

10" WHIRLWIND

Yes, Toro's lowest price money, yet it contains most of the features of higher priced mowers!

To help make mowing easy, the 10" Whirlwind features:

- 4 horsepower starting and 3.5 horsepower 4-cycle engine
- "Auto Oil" Vane Oil Filler
- Water Clean-out Port

OTHER ROTARY MOWERS
Reg. 69.95 with 3 H.P. Briggs & Stratton Motor

\$48.88

LAWN TRIMMER-EDGER

U-272

Save \$11.62 Regularly \$41.50
Black & Decker's specially fitted

Also Save \$11.62 Regularly \$44.50
Complete with easy-to-use wheels

U-276 LAWN TRIMMER-EDGER
W/ Wheels \$32.88

\$29.88

FARMER'S SPECIAL!

TRUE TEMPER
IRRIGATING SHOVEL

Reg. 7.39
\$4.44

PROPANE TORCH TANK

Reg. 1.79
99c

THERMOGRIP

Electric Glue Gun Kit

SAVE \$1.95

STEEL TAPE

WHITE CLAD

50 Foot

Reg. 4.95
NOW \$2.99

SWAN RUBBER HOSE

5/8" by 50 ft.
Regularly \$10.45
\$7.99

OUR BEST HOSE BUY!

5/8" by 50' NYLON REINFORCED, REG. 8.95 - NOW **\$4.99**

SUPER KEM TONE

REG. \$7.89
NOW \$5.87 gal.
REG. \$2.60
NOW \$1.92 qt.

SUPER KEM GLO

REG. 3.03
NOW \$1.56 pint
REG. 3.28
NOW \$2.54 qt.
REG. 10.59
NOW \$7.72 gal.

Solid Colors Only

FOR RENT

POWER LAWN RAKE

YOUR LAWN DESERVES IT... PHONE 733-5477

PRICE HDWE. CO.

147 Main Ave. W.
TWIN FALLS

DIRECT FROM FACTORY PURCHASE

MELMAC

Ideal For Campers, Trailers, Homes, Clubs and Churches.

DINNER PLATE

Decorated
Reg. 2.50, Sale Price... **97c**

SOUP-CEREAL

Large 20-oz.
Reg. 1.50, Sale Price... **48c**

VEGETABLE BOWL

40-oz.
Reg. 2.50, Sale... **89c**

CUP

Reg. Price 1.00, Sale Price... **39c**

SAUCER

Reg. Price 65c, Sale Price... **19c**

CORNING WARE PRODUCTS

SAUCEPAN SET
Consists of 1/2, 1 1/2, 3 qt. covered saucepans, 1 cradle, 1 detachable handle. Reg. \$14.95. SPECIAL \$12.85

STANLEY STAINLESS BOTTLES

QUART SIZE

Reg. 18.95... **10.99**

2 qt. Reg. 21.95... **13.99**

Magnalite ROASTER

15-IN.
REG. \$16.95
NOW \$12.95

IDEAL TO GIVE WONDERFUL TO HAVE

REVERE SAUCE PAN

2 QUART

Regular \$9.50... **\$5.22**

WERNER ALUMINUM Extension Ladder

SPIN PROOF RUNGS*

Patented ALFLO* RUNG JOINT

20-ft.
Reg. 31.95
NOW \$22.50

PAINT ROLLER and TRAY

\$1.69... 88c

"I prefer to RENT a Blue Lustro ELECTRIC CARPET SHAMPOER. I SAVE a lot, and get lovely results!"

ONLY \$1 A DAY with purchase of Famous Blue Lustro Carpet Shampoo

Home of Scott's Products

Now Is the Time to Fertilize and Kill Weeds with Scott's

TURF BUILDER plus 2

WE CARRY ALL SCOTT'S & LAWN CARE PRODUCTS

Dear Abby

By ABIGAIL VAN BUREN

DEAR ABBY: This is for that person who writes in to say that anyone who gives others free rides to and from work on a regular basis is a "sucker." If the driver charges for the service...

ded fannies. Women of today who use the various artifices are lucky they were born 200 years ago. The following is an excerpt of an Act of Parliament, passed in 1770:

"That all women, of whatever age, rank, profession or degree, whether virgins, maids or widows, shall from and after such Act, impose upon, seduce, and betray into matrimony any of His Majesty's subjects by the means of counterfeit wench, artificial teeth, false hair, Spanish wool, iron stays, hoops, high-heeled shoes, bolstered hips, shall incur the penalty of the law in force against witchcraft and like misdemeanors and that the marriage, upon conviction, be null and void."

DEAR WISER: My insurance experts tell me that if a driver accepts money from his riders on a "share-expenses" basis only, and NOT for profit, his liability to his riders is not increased. However, policies differ in different states, so better check yours out with your insurance agent.

CONFIDENTIAL TO B.L. OF

Everybody has a problem. What's yours? For a personal reply write to Abby, Box 67900, Los Angeles, Cal. 90069 and enclose a stamped, self-addressed envelope.

DEAR ABBY: Should a gentleman walk his date to the ladies' room? And if so, should he wait for her and escort her back to the table?

DEAR ABBY: I have had dates who did, and dates who didn't, and I must say I felt "pleasantly pampered" by those who did.

The reason I am asking is this. A friend of mine said if a date ever started to walk her to the ladies' room she would tell him she knew the way, and to please stay put. Who is right? CYNTHIA

DEAR CYNTHIA: It all depends on where you are. If the place is crawling with creepily-looking characters I can understand why you would appreciate the escort service. But in respectable places, a lady can usually make it to the ladies' room and back on her own.

DEAR ABBY: I howled when I read your column about paid escorts.

Pattern Marian Martin

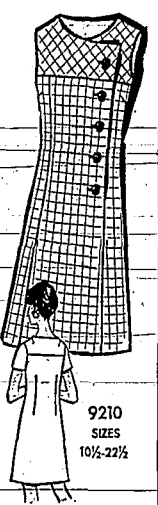

9210 SIZES 10 1/2-22 1/2

FOR HALF SIZES Isn't marvelous to look feminine, feel fresh? Step into this slide - buttoned skimmer, then step out briskly on spring and summer days.

Printed Pattern 9210: New half sizes 10 1/2, 12 1/2, 14 1/2, 16 1/2, 20 1/2, 22 1/2. Size 14 1/2 (bust 37) takes 3 1/2 yards 35". Sixty-five cents in coins for each pattern - add 15 cents for each pattern. Contact rules for mailing and special handling. Send to Marian Martin, Times-News, 385, Pattern Dept., 222 West 18th St., New York, N.Y. 10011. Print name, address with zip, size and style number.

Let the Profile Bread Plan help prolong your Slender Years.

Selling Flowers? Use Classifieds Classification 6



PREPARING TO MAKE candy to be sent to servicemen are members of the VFW Auxiliary, seated from left, Mrs. Addie Radakovich, Mrs. David Visser and Mrs. Ivan Walters, and standing from left, Mrs. Max Gardoski, Mrs. John Price and Mrs. Harold Billings. "Operation Gift Package" is the current project undertaken by the auxiliary in observance of Loyalty Day which is May 1. Packages will be sent to servicemen serving at home and overseas. The candy, made at the home of Mrs. Price, is just one of the items that will be included in the packages.

Ballots Cast By Sorority Unit

GLENN'S FERRY — "Girl of the Year" was chosen by ballot at the April meeting of Alpha Delta Chapter, Beta Sigma Phi, and her name will be revealed at the traditional Mothers' Day Tea May 5.

Mrs. Joan Woods was hostess for the meeting held at the home of Mrs. Nancy Montgomery. Mrs. Elvina Willis, president, was chosen as the "girl of the year" to attend the national convention in Reno May 24 through 26.

A public party was held recently at the Moose Hall to raise funds to send another member to the convention, which is planned for May 24. Mrs. Gloria Swall, owner of the City Florist Shops in Glenn's Ferry and Mountain Home, was the guest speaker. The lady how to keep-cut flowers, loquet and demonstrated arranging flowers.

Mrs. Linda Smitck won a special prize. Mrs. Norma Severson and Mrs. Betty Weir will present the program at the Thursday meeting at 8 p.m. The place of the meeting will be announced.

Beverly Park, Pacione Plan May Wedding

Mr. and Mrs. Kenneth Park, Filer, announce the engagement and forthcoming marriage of their daughter, Beverly Jean, to Joseph S. Pacione, son of Mr. and Mrs. Edson Johnson, Twin Falls.

Miss Park, a graduate of the High School, is attending the College of Southern Idaho and is employed by Mountain States Telephone Co.

Mr. Pacione is a graduate of Twin Falls High School and is attending the College of Southern Idaho. He is employed by Albertson's Food Center.

A May 11 wedding is planned at St. Edward's Catholic Church, Twin Falls.

Area WOTM Enrolls Member

BUHL — Mrs. Ernest Covey was enrolled as a new member when the Women of the Moose held their regular meeting with Mrs. Tom Novacek, senior reporter, presiding. Balloting was held on five new candidates and the five were approved for membership.

Mrs. Chet Wigington of the building committee presented an estimate for carpentry of the Moose Hall. It will be acted upon by the building committee. A committee will be appointed to explain the "Light the Way" project to the members before a decision on letting the project is reached. Mrs. Darrel Loos was appointed to investigate the program of sending a "Girl to Girls' State."

Members consented to the purchase of a large coffee percolator for the kitchen. Consent was also given to get dispensations to enroll two new members. Committee reports were heard from publicity, social service, Moosechance and the academy of friendship. Hosts for the evening were Mr. and Mrs. Clifford Brown. Mrs. Bill Hass and Mr. and Mrs. Emil Bernardi.

"Operation Gift Package" Is Project For VFW Unit

Mrs. Dave Visser, president of the Ladies Auxiliary to the Veterans of Foreign Wars, announced today that her auxiliary has chosen "Operation Gift Package" as a project for the observance of Loyalty Day on May 1. Packages are to be sent to servicemen serving at home and overseas.

"This will emphasize home-front special interest in and support for our fighting men on the line in Vietnam," Mrs. Visser stated. The packages will contain unperishable food items, candy, powdered fruit drinks, stationery, books, cards, comics, shoes, jackets and toiletry articles.

Mrs. Harold Billings and Mrs. John Price are co-chairmen of the project. Anyone wanting to donate items can call 733-7105 or 733-3847.

Members of the auxiliary met at the home of Mrs. Price recently to make tally for the packages. It was reported that several decks of playing cards have been donated by a business firm in Jackpot. A local business donated books. Names of veterans serving overseas are

T. F. Hosts 100 Women At Spring Presbyterial Meet

More than 100 women registered for Spring Presbyterial of three churches. Southern Idaho which was held recently in the Fireside Lounge of the Presbyterian Church, conducted a discussion on Christian education at the afternoon session. Mrs. Key Barney, Rexburg, and Jeanette Pool, Idaho Falls, reported on program. National Missions, and Synodical President Isabel Shaw, Idaho Falls, special guests. Mrs. Mary Brown, Twin Falls, welcomed visitors to the meeting.

80th Birthday Is Observed

MALTA — Mrs. Floeste Smith, MALTA, was honored at an open house reception recently at the home of her son and daughter-in-law, Mr. and Mrs. Nancy Smith, Rupert, in observance of her 80th birthday anniversary. Mrs. Smith has been a Maltese resident for 60 years and has been active throughout her life. "I have had dates who did, and dates who didn't, and I must say I felt 'pleasantly pampered' by those who did."

HOT WATER SALE

**WATER HEATERS
GLASS LINED -- 10 YEAR GUARANTEE
QUICK RECOVERY**

Reg. \$79.95	42 gal.	Now \$54.95
Reg. \$89.95	52 gal.	Now \$59.95
Reg. \$119.95	42 gal. Table Top	Now \$89.95

● U-Haul ● Delivery ● Available

*EASY CREDIT TERMS
GREENAWALT'S
JEROME STORE ONLY
Jerome, Idaho Phone 324-4831

Colorful Carpeting

10-Year Wear Guarantee
Exceeds FHA Requirements

- Choose from several colors
- Easy-to-clean Nylon

SPECIALLY PRICED

\$5.95

ONLY — Sq. Yd.

CLAUDE BROWN'S
OVER 80 ROLLS FOR YOUR SELECTION

Why buy from small sample swatches — buy from the roll and you can see what your rug will look like in your home.

CARPET IS OUR SPECIALTY

Claude BROWN'S

143 Main Ave., E. Twin Falls

Shop this newspaper for a low paint price...

then forget it and give your home

Bennett's Tender Loving Care

...an Extra Year or Two of Wear

Bennett's Colorize® Paints last from 1 to 2 years longer than most bargain-priced paints — inside or outside. People who use Bennett's Paints say it's worth it. For outside, ask for Bennett's VIKO Latex House Paint. For inside, get Bennett's Rubber Latex Wall Paint. Made for people who don't like to paint, so often.

BENNETT'S TWIN FALLS GLASS & PAINT CO.
1863 ADDISON AVE. EAST, TWIN FALLS

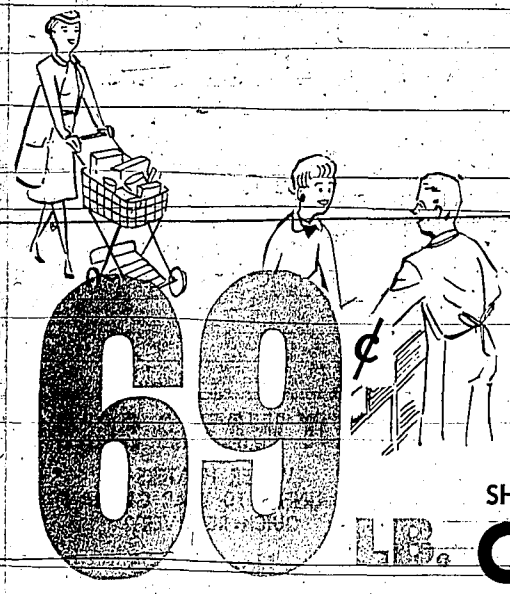

69¢

CHALLENGE SHARP AGED CHEDDAR **CHEESE**

Cut from Jumbo 1200 lb. Blocks
SPECIALLY MADE FOR BUTTREYS
FREE SAMPLES FRIDAY AND ALL DAY SATURDAY

DEL MONTE GARDEN SHOW

AT BUTTREY FOODS

DEL MONTE TOMATO
CATSUP ... 3 26-OZ. BTTL. 98¢

DEL MONTE
SPINACH ... 5 303 TINS 98¢



WE FEATURE IDAHO BEEF
SATISFACTION GUARANTEED OR MONEY BACK

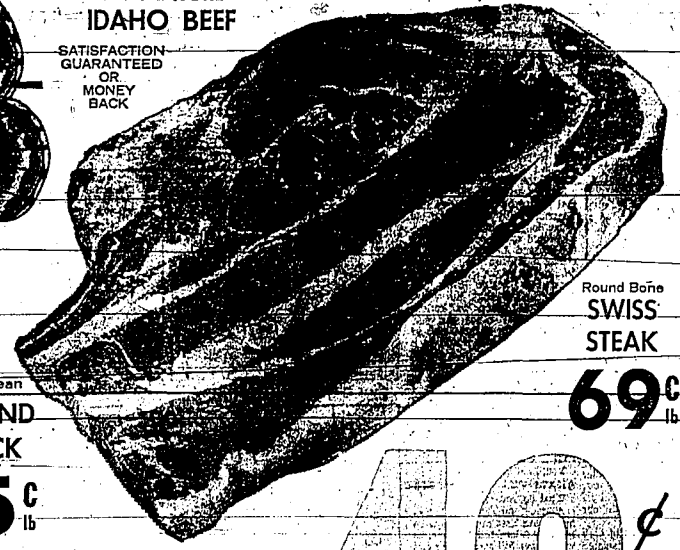

Round Bone SWISS STEAK **69¢ lb**

SKINLESS FRANKS
FALLS BRAND **89¢**
2 ... lb. pkg.

SLICED BACON
PIERCE'S PENNYWISE **59¢**
LB.

LIVER SAUSAGE
FALLS BRAND **39¢**
LB.

Fresh - Lean
GROUND CHUCK 65¢ lb

U.S.D.A. CHOICE
CHUCK STEAK 49¢ lb

DEL MONTE - CREAM STYLE OR
WHOLE KERNEL CORN ... 4 303 TINS 98¢

DEL MONTE
Fruit Cocktail ... 4 303 TINS 98¢

DEL MONTE
Krinkle Cut Beets 3 303 JARS 59¢

DEL MONTE - DICED OR
Sliced Carrots ... 4 303 JARS 89¢

BUTTREYS DELISHUS
HOT DOG OR HAMBURGER
BUNS 39¢
DOZEN

DEL MONTE
Sauerkraut 5 303 TINS 98¢

DEL MONTE - SECTIONS
Grapefruit ... 3 303 TINS 89¢

BEST FOODS
Mayonaisse Qt. JAR 69¢

BUTTREYS DELISHUS
COOKIES 4 doz. \$1.00

BUTTREYS DELISHUS BOSTON CREAM
PIE EA. 79¢



DEL MONTE "ASSORTED"
FRUIT DRINKS 3 46 oz. tins 89¢

DEL MONTE ASSORTED PICKLES
• 12 oz. Dill Chips
• 15 oz. Cucumber Chips
• 14 oz. Hot Dog Relish
• 14 oz. Hamburger Relish
• 14 oz. Sweet Relish
3 Jars 98¢



PINK - DISHWASHING LIQUID
LUX 59¢
REG. 93¢ VALUE
32 oz. bottle
Reg. Size Bar Soap
PINK LUX ... 3 bar 29¢
Home Laundry Size
ALL DETERGENT ... ea. \$4.09
7¢ off label - 20 oz. packages
DISHWASHER ALL ... pkg. 39¢

FREE!
ZENITH PORTABLE SOLID STATE STEREOPHONIC RECORD PLAYER
NOTHING TO BUY - JUST REGISTER EACH TIME YOU ARE IN OUR STORE! YOU DON'T HAVE TO BE PRESENT TO WIN ...
To Be Given Away Sat. Night, 4/20/68 at 6 p.m.
LAST WEEKS WINNER ...
RANDY KING
235 MADRONA

MONEY ORDERS
FEE **10¢**

DEL MONTE - SWEET
EARLY GARDEN PEAS ... 4 303 TINS 98¢

DEL MONTE - FRENCH STYLE OR
Cut Green Beans 4 303 TINS 98¢

DEL MONTE
Peas And Carrots 3 303 TINS 69¢

DEL MONTE
Tomato Sauce ... 9 8-OZ. TINS 98¢

DEL MONTE - TOMATO
Juice ... 3 46-OZ. TINS 98¢

DEL MONTE
Applesauce 4 303 TINS 89¢

YELLOW MARGARINE
Blue Bonnet ... 3 1 LB. PKGS. 89¢

DEL MONTE - REG. OR PINK

PINEAPPLE GRAPEFRUIT
DRINK 3 46 oz. tins 89¢



FRESH CRISP
HEAD LETTUCE 4 \$1.00
heads for

2-lb. Cello Bag
FRESH **CARROTS 4 \$1.00**
BAGS

CABBAGE 4 heads \$1.00



NEW STORE HOURS
9 A.M. - 9 P.M. WEEKDAYS
10 A.M. - 7 P.M. SUNDAYS

IN TWIN FALLS WHERE THRIFTY THOUSANDS SHOP

Beekeeper, Bees Home From Winter In South

BETHLE, Pa. (AP)—Lois of south to south for the winter...

Paul Zeigler and his estimated 17 million bees recently returned from Florida...

"Everything went fine this time," he said, "partly because it rained just about all the way home..."

Zeigler has taken bees from this southeastern Pennsylvania community to Florida for 22 years...

National Product Is At New High

WASHINGTON (AP)—The government reported Tuesday a record dollar increase in the nation's economy during the first three months of this year...

BERRY'S WORLD



© 1954 by NEA, Inc. "It's yours an old button, too?"

Government Faced With Unusual Suit

WASHINGTON (AP)—The government was faced with the threat of an unusual lawsuit Tuesday following charges that the nation's school lunch program is failing to feed millions of children too poor to buy a hot lunch...

Western Man Growing Too Big For Good

ATLANTIC CITY, N.J. (AP)—A Nobel Prize-winning chemist from Finland said Tuesday that Western man is eating too well and growing too big for his own heart and his own good...

Western Man Growing Too Big For Good

her away from the pumping source. He suggested that the leaner diet of Asians may be best, and asked, "Is the Asian type of man of a small size more fit to survive in due course of time?"

Editor Takes Look At Red Viet Industry

MIAMI, Fla. (AP)—In a journey through the country provinces of North Vietnam, editor William C. Baggs of The Miami News says he saw "the most difficult war" the United States has ever fought...

Let WANT ADS Work for You



convert unwanted items into cash for as little as \$1.15 Now is the time to fatten your bank account with WANT AD profits!

Let WANT ADS Work for You

convert unwanted items into cash for as little as \$1.15 Now is the time to fatten your bank account with WANT AD profits!

Table showing advertising rates per word for 1 Day, 4 Days, 7 Days, and 10 Days. Includes columns for 'Words' and 'Chg. Cash'.

THE TIMES-NEWS, CLASSIFIED-DEPT., TWIN FALLS, IDAHO Starting Date... Run My Ad For... Days

CLASSIFIED DEADLINE 5:00 P.M. PREVIOUS DAY Monday: 12 Saturday: 5 P.M. Friday

CLASSIFIED OFFICE HOURS 8:30 a.m., till 5:00 p.m. Monday thru Friday Saturday: 8:30 a.m. till 12:00

Classified

TO PLACE YOUR WANT AD PHONE 733-0931 ASK FOR "Classified" Other Major Valley Residents In: Buhl, Castleford, Rupert, Burley, Declo, Paul and Norland, Wendell, Gooding, Hagerman, Jerome, Dial 536-2535 Filer, Hollister, Rogerson, Jackpot, Nevada, Dial 326-5375

DEADLINES

Monday thru Friday 5:30 Day Before Publication Saturday for Monday Publication 12:00 Noon Words 2 4 7 Month To 19 3.25 4.50 9.50 To 21 4.5 5.60 11.95 To 25 4.85 5.75 14.30

DIRECTORY ANNOUNCEMENTS

Classification 1 through 15 EMPLOYMENT Classification 18 through 24 FINANCIAL Classification 30 through 38 SCHOOLS-INSTRUCTION Classification 40 through 46 REAL ESTATE Classification 50 through 62 RENTALS Classification 70 through 88 AGRICULTURE Classification 90 through 95 LIVESTOCK Classification 100 through 116 MISCELLANEOUS Classification 120 through 160 AIRCRAFT AND BOATS Classification 165 through 173 AUTOMOBILE Classification 180 through 200

Personals-Special Notices

EXPERIENCE the easy way. Rent a car. Massage roller. Hot vibrator. Bicycles. Danter Furniture, 733-0931. SRINGLES adult club 733-8333. Residential-Car Pools 10 NEED someone to give new Volkswagen to L. A. in next 3 days. We will pay \$1. Write or come to 1245 Broadway, Twin Falls.

HELP WANTED

Must be rest. attractive, 21-30 years of age. No experience necessary. *Also opening for food waitress. APPLY IN PERSON Guy Keep Cactus Pete's Jackpot, Nevada

WANTED

PLASTERING - stucco - peck-tank cement - plaster - patch work. Contact Christopher, 733-0931. BOYS Applications being taken for general instruction, discipline, and work habits. Contact Jim Robinson, Cactus Pete's, Jackpot, Nevada.

PERSONALS

EXPERIENCE the easy way. Rent a car. Massage roller. Hot vibrator. Bicycles. Danter Furniture, 733-0931. SRINGLES adult club 733-8333. Residential-Car Pools 10 NEED someone to give new Volkswagen to L. A. in next 3 days. We will pay \$1. Write or come to 1245 Broadway, Twin Falls.

FORM WORK WANTED

OWNER seeking nearly new apartment building. Write to 733-0931. RENTAL purchase plan. Write to 733-0931. PIANO LESSONS Beginning and intermediate call Mrs. Barbara Sackett 733-8333.

Form Work Wanted

OWNER seeking nearly new apartment building. Write to 733-0931. RENTAL purchase plan. Write to 733-0931. PIANO LESSONS Beginning and intermediate call Mrs. Barbara Sackett 733-8333.

MANURE HAULING

LEO'S CUSTOM FARMING Filer 326-4703 CUSTOM MANURE HAULING Twin Falls 733-8333 CUSTOM FARMING FLOWING, DISCING Merle Kowitman 733-8315

THE LAND OFFICE OF IDAHO

Water Kaskas and springs New Split-Level 2 bedrooms, 3 baths, large living room, dining room, kitchen and breakfast room. Call 733-0931.

SHAW REALTY

BEAUTIFUL 1 bedroom brick home with patio, fireplace and garage. Call 733-0931.

NEW HOME

3 bedrooms, 2 baths, large living room, dining room, kitchen and breakfast room. Call 733-0931.

Homes For Sale

2069 RANCHO VISTA This beautiful landscaped home has 3 bedrooms, full bath, tile floor, living room and carpeting. Call 733-0931.

SHAW REALTY

BEAUTIFUL 1 bedroom brick home with patio, fireplace and garage. Call 733-0931.

NEW COMPACT

3 bedrooms, large living room, dining room, kitchen and breakfast room. Call 733-0931.

HIGH STYLE

New 2 bedroom home. Richly carpeted throughout. Call 733-0931.

MUSIC LESSONS

Beginner and intermediate call Mrs. Barbara Sackett 733-8333.

MAGIC VALLEY TOLL FREE NUMBERS
Dial, Castleford,
Hogsett, Jerome,
Dial 536-255
Burley, Rupert, Declo,
Paul, Norland
Dick, New, Dial 536-5375

A-8 Twin Falls Times-News April 17-18, 1968 Homes for Sale 50 Compers 52 Mobile Homes 63 Apartments-Furnished 64 Apartments-Unfurnished 71 Farm Implements 90 Cattle 102

WANTED-TRADER BUY...
KAMPVAAY CAMPERS AND PICKUP COVERS
Magic Valley Mobile Homes
COMPLETE MOBILE HOME and Travel Trailer Service
BAKER'S MOBILE HOMES

WANTED-TRADER BUY...
KAMPVAAY CAMPERS AND PICKUP COVERS
Magic Valley Mobile Homes
COMPLETE MOBILE HOME and Travel Trailer Service
BAKER'S MOBILE HOMES

WANTED-TRADER BUY...
KAMPVAAY CAMPERS AND PICKUP COVERS
Magic Valley Mobile Homes
COMPLETE MOBILE HOME and Travel Trailer Service
BAKER'S MOBILE HOMES

WANTED-TRADER BUY...
KAMPVAAY CAMPERS AND PICKUP COVERS
Magic Valley Mobile Homes
COMPLETE MOBILE HOME and Travel Trailer Service
BAKER'S MOBILE HOMES

USED BUYS REGISTERED HEREFORDS Service Area BULLS
Edward C. Eakin & Sons
Route 1, 104 2nd, Jerome
WE-SLAUGHTER
On Farm Slaughtering
Lamb
North Main Lockers
For sale, service, call 733-952
LIVING 733-952

WANTED-TRADER BUY...
KAMPVAAY CAMPERS AND PICKUP COVERS
Magic Valley Mobile Homes
COMPLETE MOBILE HOME and Travel Trailer Service
BAKER'S MOBILE HOMES

WANTED-TRADER BUY...
KAMPVAAY CAMPERS AND PICKUP COVERS
Magic Valley Mobile Homes
COMPLETE MOBILE HOME and Travel Trailer Service
BAKER'S MOBILE HOMES

WANTED-TRADER BUY...
KAMPVAAY CAMPERS AND PICKUP COVERS
Magic Valley Mobile Homes
COMPLETE MOBILE HOME and Travel Trailer Service
BAKER'S MOBILE HOMES

WANTED-TRADER BUY...
KAMPVAAY CAMPERS AND PICKUP COVERS
Magic Valley Mobile Homes
COMPLETE MOBILE HOME and Travel Trailer Service
BAKER'S MOBILE HOMES

USED BUYS REGISTERED HEREFORDS Service Area BULLS
Edward C. Eakin & Sons
Route 1, 104 2nd, Jerome
WE-SLAUGHTER
On Farm Slaughtering
Lamb
North Main Lockers
For sale, service, call 733-952
LIVING 733-952

WANTED-TRADER BUY...
KAMPVAAY CAMPERS AND PICKUP COVERS
Magic Valley Mobile Homes
COMPLETE MOBILE HOME and Travel Trailer Service
BAKER'S MOBILE HOMES

WANTED-TRADER BUY...
KAMPVAAY CAMPERS AND PICKUP COVERS
Magic Valley Mobile Homes
COMPLETE MOBILE HOME and Travel Trailer Service
BAKER'S MOBILE HOMES

WANTED-TRADER BUY...
KAMPVAAY CAMPERS AND PICKUP COVERS
Magic Valley Mobile Homes
COMPLETE MOBILE HOME and Travel Trailer Service
BAKER'S MOBILE HOMES

WANTED-TRADER BUY...
KAMPVAAY CAMPERS AND PICKUP COVERS
Magic Valley Mobile Homes
COMPLETE MOBILE HOME and Travel Trailer Service
BAKER'S MOBILE HOMES

USED BUYS REGISTERED HEREFORDS Service Area BULLS
Edward C. Eakin & Sons
Route 1, 104 2nd, Jerome
WE-SLAUGHTER
On Farm Slaughtering
Lamb
North Main Lockers
For sale, service, call 733-952
LIVING 733-952

WANTED-TRADER BUY...
KAMPVAAY CAMPERS AND PICKUP COVERS
Magic Valley Mobile Homes
COMPLETE MOBILE HOME and Travel Trailer Service
BAKER'S MOBILE HOMES

WANTED-TRADER BUY...
KAMPVAAY CAMPERS AND PICKUP COVERS
Magic Valley Mobile Homes
COMPLETE MOBILE HOME and Travel Trailer Service
BAKER'S MOBILE HOMES

WANTED-TRADER BUY...
KAMPVAAY CAMPERS AND PICKUP COVERS
Magic Valley Mobile Homes
COMPLETE MOBILE HOME and Travel Trailer Service
BAKER'S MOBILE HOMES

WANTED-TRADER BUY...
KAMPVAAY CAMPERS AND PICKUP COVERS
Magic Valley Mobile Homes
COMPLETE MOBILE HOME and Travel Trailer Service
BAKER'S MOBILE HOMES

USED BUYS REGISTERED HEREFORDS Service Area BULLS
Edward C. Eakin & Sons
Route 1, 104 2nd, Jerome
WE-SLAUGHTER
On Farm Slaughtering
Lamb
North Main Lockers
For sale, service, call 733-952
LIVING 733-952

WANTED-TRADER BUY...
KAMPVAAY CAMPERS AND PICKUP COVERS
Magic Valley Mobile Homes
COMPLETE MOBILE HOME and Travel Trailer Service
BAKER'S MOBILE HOMES

WANTED-TRADER BUY...
KAMPVAAY CAMPERS AND PICKUP COVERS
Magic Valley Mobile Homes
COMPLETE MOBILE HOME and Travel Trailer Service
BAKER'S MOBILE HOMES

WANTED-TRADER BUY...
KAMPVAAY CAMPERS AND PICKUP COVERS
Magic Valley Mobile Homes
COMPLETE MOBILE HOME and Travel Trailer Service
BAKER'S MOBILE HOMES

WANTED-TRADER BUY...
KAMPVAAY CAMPERS AND PICKUP COVERS
Magic Valley Mobile Homes
COMPLETE MOBILE HOME and Travel Trailer Service
BAKER'S MOBILE HOMES

USED BUYS REGISTERED HEREFORDS Service Area BULLS
Edward C. Eakin & Sons
Route 1, 104 2nd, Jerome
WE-SLAUGHTER
On Farm Slaughtering
Lamb
North Main Lockers
For sale, service, call 733-952
LIVING 733-952

WANTED-TRADER BUY...
KAMPVAAY CAMPERS AND PICKUP COVERS
Magic Valley Mobile Homes
COMPLETE MOBILE HOME and Travel Trailer Service
BAKER'S MOBILE HOMES

WANTED-TRADER BUY...
KAMPVAAY CAMPERS AND PICKUP COVERS
Magic Valley Mobile Homes
COMPLETE MOBILE HOME and Travel Trailer Service
BAKER'S MOBILE HOMES

WANTED-TRADER BUY...
KAMPVAAY CAMPERS AND PICKUP COVERS
Magic Valley Mobile Homes
COMPLETE MOBILE HOME and Travel Trailer Service
BAKER'S MOBILE HOMES

WANTED-TRADER BUY...
KAMPVAAY CAMPERS AND PICKUP COVERS
Magic Valley Mobile Homes
COMPLETE MOBILE HOME and Travel Trailer Service
BAKER'S MOBILE HOMES

USED BUYS REGISTERED HEREFORDS Service Area BULLS
Edward C. Eakin & Sons
Route 1, 104 2nd, Jerome
WE-SLAUGHTER
On Farm Slaughtering
Lamb
North Main Lockers
For sale, service, call 733-952
LIVING 733-952

WANTED-TRADER BUY...
KAMPVAAY CAMPERS AND PICKUP COVERS
Magic Valley Mobile Homes
COMPLETE MOBILE HOME and Travel Trailer Service
BAKER'S MOBILE HOMES

WANTED-TRADER BUY...
KAMPVAAY CAMPERS AND PICKUP COVERS
Magic Valley Mobile Homes
COMPLETE MOBILE HOME and Travel Trailer Service
BAKER'S MOBILE HOMES

WANTED-TRADER BUY...
KAMPVAAY CAMPERS AND PICKUP COVERS
Magic Valley Mobile Homes
COMPLETE MOBILE HOME and Travel Trailer Service
BAKER'S MOBILE HOMES

WANTED-TRADER BUY...
KAMPVAAY CAMPERS AND PICKUP COVERS
Magic Valley Mobile Homes
COMPLETE MOBILE HOME and Travel Trailer Service
BAKER'S MOBILE HOMES

USED BUYS REGISTERED HEREFORDS Service Area BULLS
Edward C. Eakin & Sons
Route 1, 104 2nd, Jerome
WE-SLAUGHTER
On Farm Slaughtering
Lamb
North Main Lockers
For sale, service, call 733-952
LIVING 733-952

WANTED-TRADER BUY...
KAMPVAAY CAMPERS AND PICKUP COVERS
Magic Valley Mobile Homes
COMPLETE MOBILE HOME and Travel Trailer Service
BAKER'S MOBILE HOMES

WANTED-TRADER BUY...
KAMPVAAY CAMPERS AND PICKUP COVERS
Magic Valley Mobile Homes
COMPLETE MOBILE HOME and Travel Trailer Service
BAKER'S MOBILE HOMES

WANTED-TRADER BUY...
KAMPVAAY CAMPERS AND PICKUP COVERS
Magic Valley Mobile Homes
COMPLETE MOBILE HOME and Travel Trailer Service
BAKER'S MOBILE HOMES

WANTED-TRADER BUY...
KAMPVAAY CAMPERS AND PICKUP COVERS
Magic Valley Mobile Homes
COMPLETE MOBILE HOME and Travel Trailer Service
BAKER'S MOBILE HOMES

USED BUYS REGISTERED HEREFORDS Service Area BULLS
Edward C. Eakin & Sons
Route 1, 104 2nd, Jerome
WE-SLAUGHTER
On Farm Slaughtering
Lamb
North Main Lockers
For sale, service, call 733-952
LIVING 733-952

NEED AN EXPERT? USE THIS HANDY DIRECTORY AS A GUIDE TO FAST, RELIABLE SERVICE, PHONE TODAY FREE ESTIMATES.

24 HOUR ANSWERING SERVICE
If The Telephone of Any Advertiser in This Directory is Not Answered, Dial 733-2866.
The Advertiser Will Be Notified to Call You.

Listed here in easy-to-find alphabetical order, are service offers you can use every day. Contact one of these firms or individuals for better service and first quality products.

Air Conditioning, Heating and furnace cleaning. For the best service call the "Pumpac Company"-733-3261.

For the Best in Aluminum Siding, Call the "Aluminum Siding Co."-733-2506.

George's Kennel, Boarding all breeds, training all breeds. 227 West 4th, Jerome, Idaho 83421.

Building Contractors: Steel, frame or masonry, commercial or residential buildings. Free estimates. Call Hamilton Insurance and Roofing, 733-2506.

Medical: Ruptures cured without hospital, surgery. Insurance accepted, send for literature. Appointments only. Dr. A. Turka M.D., 820, Phone 866-773, Box 386, Idaho Falls, Idaho 83402.

Milking Equipment: Bulk milk tank and pipeline system - call Lawler & Jerome, 733-4291.

Ornamental Iron: Ornamental iron, cast and wrought iron. Free estimates. Call "Ornamental Iron", 733-2506.

Painting: Stain Brothers interior and exterior, commercial and residential. Sand blasting, 733-1184 or 733-1948.

Plumbing: Plumbing Service & Repair, 224 S. 2nd, Jerome, Idaho 83401, Main 50, 733-2523.

Rentals: FOLDING chairs and tables, any number. Also, lawnmower sharpener. Call "Rentals", 733-2506.

Septic Tank: Would like doctor, sanitarians, and grader work. Call A. Farrell, Phone 733-2506.

Excavation: Would like doctor, sanitarians, and grader work. Call A. Farrell, Phone 733-2506.

Fuel Oil: Give quote and furnace oil, call Gene Stale, Oil 733-952, OR DELIVERY warm inside.

Gun Repair: Jerry's Gun Shop, Complete gun repair, 733-2506.

Homeowner: Experienced electric, home wiring, 733-2506.

Advertisement in the BUSINESS DIRECTORY sends new and old clients to you every day reaches 22,000 homes (7,000 readers), and saves on your pocket cash.

PHONE 733-0931

Published under the heading of your choice... Every day DELIVERED TO 21,000 MAGIC VALLEY HOUSEHOLDS DAILY PHONE YOUR AD TODAY 733-0931

MAILED BY MAIL A TRAINED AD-WRITER WILL HELP YOU

Published under the heading of your choice... Every day DELIVERED TO 21,000 MAGIC VALLEY HOUSEHOLDS DAILY PHONE YOUR AD TODAY 733-0931

MAILED BY MAIL A TRAINED AD-WRITER WILL HELP YOU

Published under the heading of your choice... Every day DELIVERED TO 21,000 MAGIC VALLEY HOUSEHOLDS DAILY PHONE YOUR AD TODAY 733-0931

MAILED BY MAIL A TRAINED AD-WRITER WILL HELP YOU

Horses 104
SOUTHWEST HENS, high production Appaloosa Stallion Integrate Appaloosa point yearly yielding high point yearly yield. Standing at 1900 New York Ave., Boise, Idaho 83724.

Cut Flowers 138
LILIES, Mums, Asters, cut flowers for occasions. Phone 733-2113.

Autos For Sale 200
1967 RAMBLER Rebel V8, 4-door Sedan, Like new, Radio, heater, power steering and automatic. Only \$2295

Autos for Sale 200
1966 CHEVROLET V8 Impala, 2-door hardtop, with factory air conditioning. Now \$1997

Autos for Sale 200
1965 PONTIAC Catalina 2-door hardtop. Sharp \$1895

Antiques 139
ACTUAL - MINTS
On this fine edition, 2 year new issue and up. Phone 733-2113

Autos For Sale 200
1965 DODGE Dart, 4-door Sedan, Extra Clean. \$1295

Autos For Sale 200
1964 CHEVROLET 4-door Sedan with factory air conditioning. \$1197

Autos For Sale 200
1964 CHEVROLET V8 4-door with factory air conditioning. \$1197

Autos For Sale 200
1964 CHEVROLET V8 4-door with factory air conditioning. \$1197

Antiques 139
KOPPEL'S BROWNEVILLE
FURNITURE and Trade: Paints, oil, varnish, wallpaper, etc.

Autos For Sale 200
1966 CHEVROLET 4-door Sedan, Like new, Radio, heater, power steering and automatic. Only \$2295

Autos For Sale 200
1966 CHEVROLET V8 Impala, 2-door hardtop, with factory air conditioning. Now \$1997

Autos For Sale 200
1965 PONTIAC Catalina 2-door hardtop. Sharp \$1895

Autos For Sale 200
1965 DODGE Dart, 4-door Sedan, Extra Clean. \$1295

Autos For Sale 200
1964 CHEVROLET 4-door Sedan with factory air conditioning. \$1197

Autos For Sale 200
1964 CHEVROLET V8 4-door with factory air conditioning. \$1197

Autos For Sale 200
1964 CHEVROLET V8 4-door with factory air conditioning. \$1197

Autos For Sale 200
1964 CHEVROLET V8 4-door with factory air conditioning. \$1197

Autos For Sale 200
1964 CHEVROLET V8 4-door with factory air conditioning. \$1197

Autos For Sale 200
1964 CHEVROLET V8 4-door with factory air conditioning. \$1197

Autos For Sale 200
1964 CHEVROLET V8 4-door with factory air conditioning. \$1197

Autos For Sale 200
1964 CHEVROLET V8 4-door with factory air conditioning. \$1197

Autos For Sale 200
1964 CHEVROLET V8 4-door with factory air conditioning. \$1197

Autos For Sale 200
1964 CHEVROLET V8 4-door with factory air conditioning. \$1197

End Of The Month CLEARANCE
1964 CADILLAC 1965 FALCON
\$2315 \$1285
1964 CONTINENTAL 1965 FORD
\$2165 \$1285
1965 PLYMOUTH 1962 FORD
\$1835 \$1185
1964 BUICK 1960 CORVAIR
\$1565 \$128

NO NEED TO WATCH THE CARS GO BY!
HUGE USED CAR SALE
1-348 1963 CHEVROLET Suburban \$1095
1-131 1963 CHEVROLET Impala sedan \$1035
1-107 1961 CHEVROLET Impala Sedan \$795
1-107 1963 CHEVROLET BelAir Sedan \$950

As Always Dodge City
Offers You The Best 112 Top Quality Cars
Trucks Pickups
BOB REESE'S DODGE CITY

Don't Buy Anything Until You Have Shopped At YOU'RE MOTORS
1966 IMPALA 4-door Sport Sedan. V8 motor, power Glide transmission, powersteering. New tires. ONLY \$2195
1965 FORD Galaxie 500 4-door Sedan. V8 motor, Cruiseomatic transmission, power steering, factory air conditioning, new tires. VERY SHARP \$1535

WILLS Spring Clearance
WILLS USED CARS
Both Locations open Mon, thru Fri, 'til 9
Truck Lane West Office Phone 733-7385
DICK ROYD GEORGE DEE
NICK NICHOLSON STEVE MILLER

WILLS Spring Clearance
WILLS USED CARS
Both Locations open Mon, thru Fri, 'til 9
Truck Lane West Office Phone 733-7385
DICK ROYD GEORGE DEE
NICK NICHOLSON STEVE MILLER

WILLS Spring Clearance
WILLS USED CARS
Both Locations open Mon, thru Fri, 'til 9
Truck Lane West Office Phone 733-7385
DICK ROYD GEORGE DEE
NICK NICHOLSON STEVE MILLER

Women's Section

Betty Canary's Wonderful World

I try to keep an open mind about it, but I tend toward the belief that anybody can make mistakes—everybody who tags themselves An Authority.

But, although Julie's achievements were her own, I couldn't help wondering if it were all made possible because her mother helped her along the way.

Buhl Firemen Are Honored

Buhl—Five Buhl firemen were honored at the regular April meeting of the Firemen and Auxiliary. Receiving badges for faithful service to the City of Buhl were Al Davis, Darrel Leonard, Emil Haugum and Howard White, all ten year badges.

Valley Couple Celebrates 50th Wedding Anniversary

Over 300 guests attended the open-house honoring Mr. and Mrs. Don Durfee and Mrs. Lyle Putter in observance of their Golden Wedding Anniversary.

Official Visit Made To Area Old Timers Club, Auxiliary

GLENN'S TERRACE—A special General Committee, was also present. Others introduced included Mr. and Mrs. George and Mrs. Gertrude Bybee, Mrs. Willis, president of the local Junior Old-Timers Auxiliary, and Mc. Bybee president of the Junior Old-Timers meeting.

Matrons Meet

April Fool and Easter excitement were met by members of the Cheerful Matrons Club at a recent meeting.



HOME ECONOMICS instructor at Wood River High School, Janet Ambrose, right, presents Susie Johnson, member of the Junior class, the Sweepstakes Award during the home economics and Future Homemakers of America fashion show.

"Fashion Fling" Presented by Wood River Students

HAILEY—"Fashion Fling" was presented recently at the high school auditorium as the annual style show for beginners and advanced students in home economics and Future Homemakers of America classes.

Janet Ambrose, class instructor, was presented a corsage and gift from the 35 members who modeled clothing they have constructed during the year under her guidance.

Mary O'Donnell, president of the F.H.A. Chapter, gave the welcome. Styles were divided into four categories: Caters 5 to 14, modeled a Grecian robe for that period, Janis Bird was model for the Victorian age and Susan Goble wore a Charleston costume to represent the 1920's.

April Coffee Hour Scheduled

A coffee hour will be held at 1 p.m. April 24th was announced when members of the Home Extension Club met recently at the YWCA building.

Advertisement for Farm Auction Calendar, featuring a tractor illustration and details about the calendar's content and availability.

When you know the end of the story, don't you? Rosalie not only was a validation of her class but is now doing graduate work and plans to be a college physicist.

Special Offer: 4th Tire FREE. Limited time only! When you buy 3 at our low everyday trade-in price!

SAVE \$38 TO \$51 ON A COMPLETE SET. Here's the sale you've waited for! Now you can own a set of famous Firestone Wide Oval tires for about the same price.

Firestone SUPER SPORTS WIDE OVAL. The original WIDE OVAL... the most widely copied tire ever built!

NO MONEY DOWN. YOU'RE THE WINNER WHEN YOU BUY FROM THE FIRESTONE "SAFE TIRE" MAN IN THE CHECKERED SHIRT! TAKE MONTHS TO PAY. Credit established in minutes!

NICKLAUS GOLF BALLS. Autograph model by 1967 U.S. Open Champion Jack Nicklaus. 3 For \$1.33. Additional balls \$1.00 each.

ROPER'S GIVES YOU SLAX-APPEAL!



Every man needs more trim, slim, properly fitted slacks. At your Roper's store you can choose from the largest and best collections of the smartest new slacks for Spring.

CHAMPION "REGENCY 100". Clasp Press permanently used in wool dress slacks, permanently treated for better shape retention, continued freshness and wearability.

ROPER'S advertisement listing various slax styles and prices, including 'Forever Pressed' and 'BOBBY BAFFLES'.

Colossal 3-Day Sale Starts Thursday, April 18

Sears Sears Days SALE

A SALE AS GREAT AS ITS NAME!

SEE BACK PAGE FOR THURSDAY NIGHT SPECIALS

TWIN FALLS, IDAHO

Shop Daily
9:30 A.M. to 6 P.M.
Open Thurs., Fri., Mon.—Till 9 P.M.

Girls' Shifts or Pant Dresses

2 97

your choice

Choose from pretty, practical shifts or pant dresses in spring prints, stripes or dots for young charmers. In sizes 7 to 14. Washable 100% cotton in many styles.

Jamaica Sets

2 for \$5

Colorful print tops are sleeveless and matched with solid color, boxer-back shorts. All cotton, sizes 7-14.



Framed Pictures

your choice

\$7

Choose from a wide variety of mountain, seascape, Spanish, Early American, and provincial pictures. 12x18-in. to 30x54-in.

CHARGE IT on Sears Revolving Charge

Pocket T-Shirt

97¢

All cotton crew neck pocket T-shirt. Many bright colors to choose from. Sizes small to extra-large.

CHARGE IT on Sears Revolving Charge

SAVE \$3.02

***7.99 Electric Repeat Alarm Clocks**

Automatic alarm repeats every few minutes... allows you 12 wake-up calls. Top bar shut-off. White, blue or brown plastic case.

4 97

CHARGE IT on Sears Revolving Charge

Fun Loving, Sudz Loving

JEEPERS

For Women and Children

Long-wearing blend of 65% Dacron® Polyester and 35% cotton uppers. Nylon stitched seams and sturdy bindings. Full-cushioned insoles. Built-in arch for greater support. Crepe-type composition soles. Women's sizes 4-9, misses' 12 1/2-4. Children's sizes 4-12 medium. In a full rainbow of colors.

2 \$5

Pair

CHARGE IT on Sears Revolving Charge

SALE ENDS SATURDAY!

SAVE 25% to 55%

Housewares Fair

Your Choice **66¢**

- 89c Kenmore Laundry Detergent in huge 3-lb. Box 66c
 - 89c Kenmore Dish Detergent, 1-qt. 66c
 - 99c Acrylic Floor Wax, 1-qt. 66c
 - \$1.49 Plastic Single Turntables 66c
 - Teflon Ironing Table Cover 66c
 - 29c Aluminum Foil 3 rolls 66c
- CHARGE IT on Sears Revolving Charge

SAVE 28%

10W-30 Motor Oil

Regular 45c a Quart Allstate All-Weather Multi-grade motor oil. Stock up now at this low, low price.

3 97¢

1 qt. 39¢

CHARGE IT on Sears Revolving Charge

SAVE 22%

99¢ Rose Bushes

1 1/2-Grade Roses in a wide variety of colors. Easy-to-grow and care for. Popular breeds. Don't Miss Out.

77¢ ea.

CHARGE IT on Sears Revolving Charge

Sears Garden Tool Sale

For a More Beautiful Yard!

YOUR CHOICE

66¢

- 99c Craftsman Hand Weeder 66¢
- 99c Craftsman Hand Trowel 66¢
- 99c Craftsman Garden Trowel 66¢
- 99c Craftsman Culti-Hoe 66¢

CHARGE IT on Sears Revolving Charge

SHOP AT SEARS AND SAVE Satisfaction Guaranteed or Your Money Back

Sears

OPEN DAILY 9:30 a.m. to 6 p.m. SHOP MON., THURS., FRI. 'TIL 9 P.M.

PLENTY OF FREE STORESIDE PARKING

403 MAIN AVE. W. TWIN FALLS, IDAHO

SEARS, ROEBUCK AND CO.

sale! cross-country classics

Sears has every kind of shirtdress • A-lines • pantdresses • shifts • full-skirted styles • more!

greater style selection than ever!
more new fashion looks than ever!

Sears

SAVE
17% TO 25%

Everything's
Comin' Up
Roses...

Wild Rose Lingerie

Regular \$3.00
Pail Pant **2²⁷**

Regular \$4
Mini-Slip
and Pail Slip **2⁹⁷**

White and
assorted colors.

Regular \$6
Nylon Slip **4⁹⁷**

This coordinated intimate
apparel is exquisitely de-
signed to give you an aura
of feminine luxury. "Wild
Rose" lace adorns each
lovely garment of nylon
tricot. Frosty White.

Slip—sizes 32-38S, 32-
40A.

Mini-Slip—Short... S-M
Average S-M-L

NOW **6⁹⁷**

stock up now! hurry in!

Shirtresses priced so low you can collect a closet
full. Here in every version from classic to up-to-the-
minute stylings. Choose yours trimly tailored with
ticks or ruffles and feminine. Details of buttons,
collars, collars, sleeves, ruffles, hems, long-sleeved.
Cottons, polyester and cotton blends in the group.

sizes for everyone

- Misses 8-20
- Half sizes 14½-24½
- Miss Petite 8-16

variety plenty

- soft color solids
- attractive stripes
- dainty florals
- bold 'n' mini checks
- pert paisleys

- plenty of fitting rooms
- extra sales help
- friendly, efficient service

CHARGE IT on Sears Revolving Charge

CHARGE IT
on Sears Revolving Charge

**SALE
ENDS
SATURDAY**

SAVE \$1.72
**Natural or
Contour Bras**

A,B,C
Regular **2⁹⁷**
\$4.69

D CUP
REG. \$5.69 **3⁹⁷**

Take action... this bra follows your
every movement. Elastic (nylon, spandex)
side and back panels. Elastic
front bands cross to separate. Adjustable
stretch straps. Nylon lace cups.
A,B,C,D—Contour-Bra-hes-Wonder-Fit®
shopping to fill out in between sizes.
A,B,C,D.

SAVE OVER \$2
**Natural-Fit
Panty**

Regular **7⁹⁷**
\$10

Feel at ease in this powerful
elastic panty of nylon. Lycra
spandex. Elastic inner
control bands lift and firm
the tummy. Satin elastic
panel shapes the derriere.
Sizes medium to extra-large.

CLING-ALON® STRETCH NYLONS
They fit any leg, any leg, any leg, any leg

SAVE 50% a pair on Proportioned-Fit

Sears
**Semi-Annual
Proportioned-Fit
Hosiery Sale**

Regular **99^c**
\$1.49
Pair

Now, during Sears Semi-Annual Sale, save lots on our exclusive
Cling-Alon stretch nylons. Proportioned to fit in length and width
... contoured at all the vital areas. Four superb leg patterns: petite,
shapely, classic and tall. Over 200% stretch which means a comfier
fit, a smoother look. Seamless mesh knit with reinforced heel. Many
other styles to pick in fashion shades.

Sears Sells Only First Quality Hosiery... No Seconds, No Irregulars.

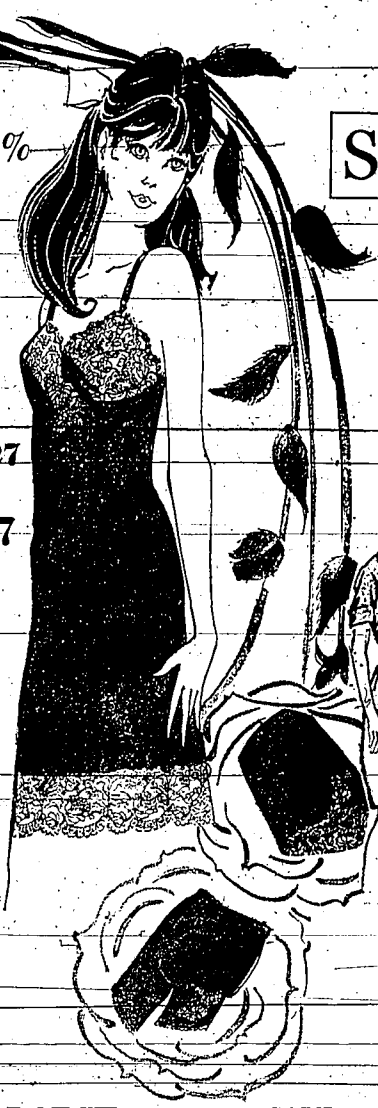
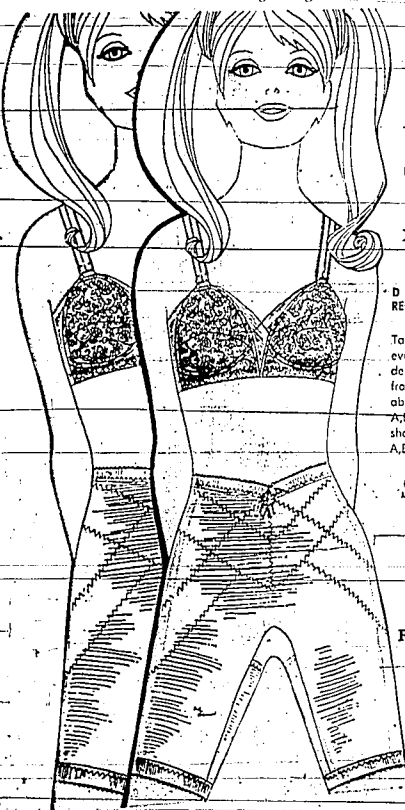

Sears

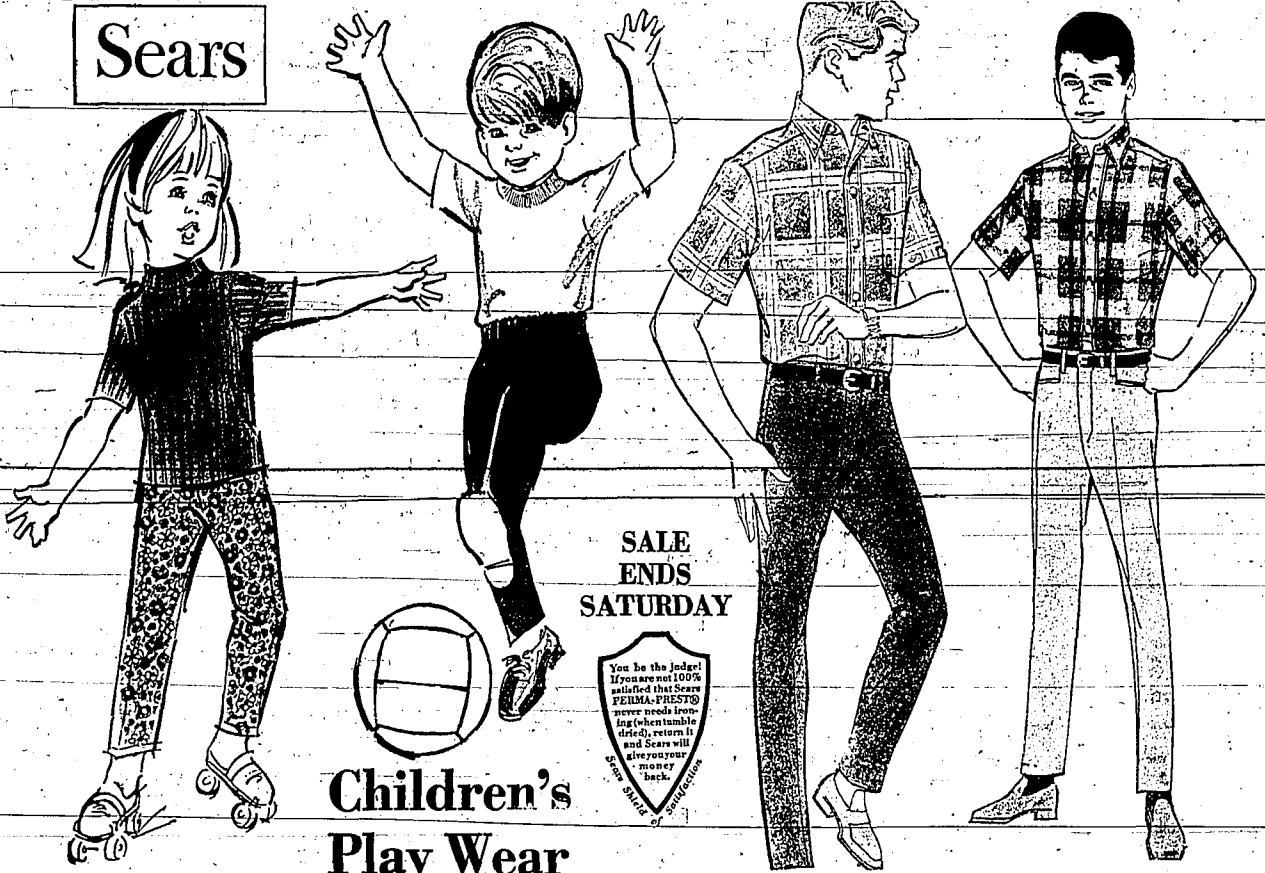

SALE
ENDS
SATURDAY

You be the Judge!
If you are not 100% satisfied that Sears PERMA-PREST® never needs ironing (when tumble dried), return it and Sears will give you your money back.
Sears, Roebuck & Co. Chicago, Ill.

Children's
Play Wear

SAVE 15% Regular \$1.89 Cotton Poor Boy Top—
Color coordinating wide-rib poor boy style tops. Sizes small, medium, large in solid pink or green.

SAVE 17% Regular \$1.79 Floral Print Pants—
Flower-sprinkled fine cotton gabardine pants have band-front, elastic back for comfy fit. Color coordinates with tops. Sizes 3-6y.

Boys' PERMA-PREST® Knit Tops and Slacks—
Short-sleeve PERMA-PREST® mock turtle-neck pullover is easy to care for, never needs ironing when tumble dried. Resistant to pillage. Assorted colors in sizes S(2-3), M(4-5), LG(6-8). Snap-front elastic knee waist keeps little boys neat. Medium weight polyester and cotton, never needs ironing when tumble dried. Choose from the season's newest fashion shades. Sizes 2-6.

1.47
1.47
Your Choice
3\$4

Boys'—Students' Shirts and Slacks

SAVE UP TO \$1.02 on The Shirts—
make the scene in new burnished colors and plaid. Fit like stained glass. Perfectly color-coordinated to slacks and sport coats. Smart blend of Fortrel® polyester and cotton tumble-dries smoothly and neat. Authentic Ivy styling with top-center plaid. Boys' sizes 6-12, Students' 13-16. Regular \$3.50.

SAVE \$1.02 on The Slacks—
complete the superlative four-color-teams in Ivy or Continental model with fashionable slash pockets and tailored back. Pressed the day they were made, they'll never need pressing again. Fortrel® polyester and cotton allows greasy stains to be washed right out. Boys' sizes 6-12, Students' 20-34.

* 2.77
BOYS \$3.99 Students' 2.97
Reg. \$4.99
Boys' 3.97
\$3.99 Students' 4.97

CHARGE IT
on Sears
Revolving
Charge

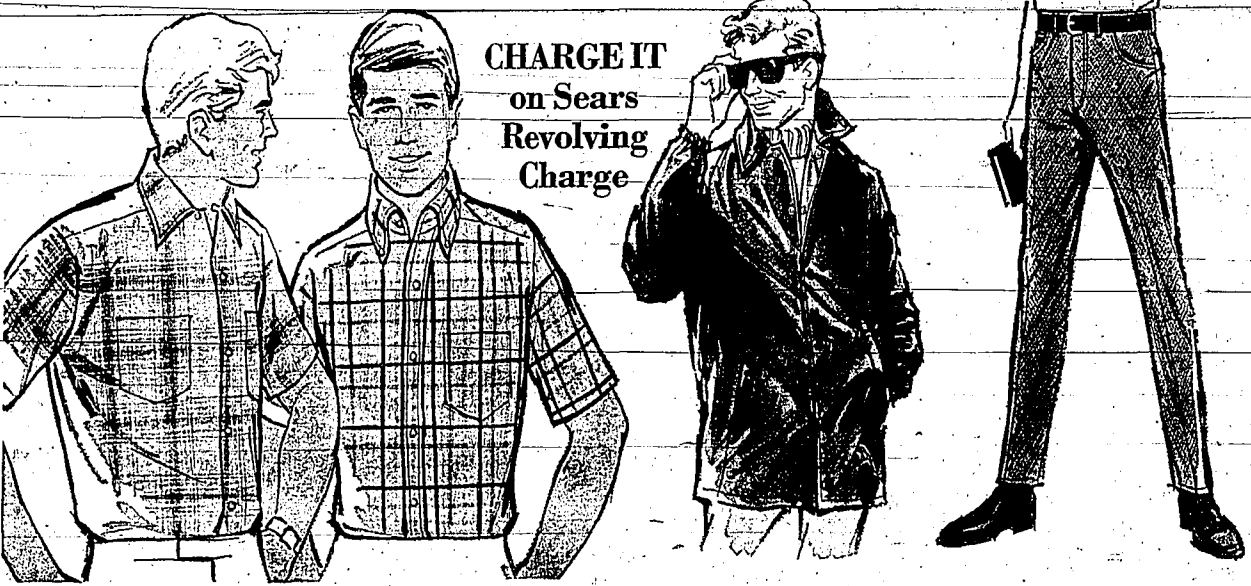

Men's Short-Sleeve
Sport Shirts

Try on this crisp look for Spring. The fashionable all-cotton shirts keep you cool and comfortable all day long. Short-sleeve style with Classic or Ivy collars. Young choice of plaids or stripes in bright Spring colors. Sizes small to large. Stock up now at this low price.

3 for \$5

Men's Casual Wear

SAVE \$1.02 ... Men's \$5.99 Warmup Jacket—
Here's real athletic styling in a thick extra heavy nylon oxford fabric with water repellent finish. Drawstring waistband, elastic cuffs, snap front. Popular hip-length. Choice of medium blue, red or navy blue. In small to extra large sizes.

SAVE \$1.02 ... \$5.99 PERMA-PREST® JEANS—
50% Fortrel® polyester, 50% cotton in a heavyweight Hopsack weave... specially treated so that the center crease stays in, wrinkles stay out... never needs ironing when tumble dried. Your choice of Loden, Whiskey, Light Tan, Medium Blue in sizes 29-30.

4.97
4.97

Sears

Sears Days SALE

A SALE AS GREAT AS ITS NAME!

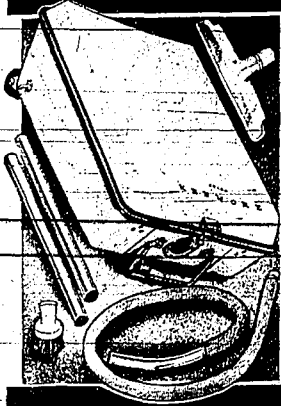

Kenmore Canister Cleaner

- Includes 5-piece set of home cleaning attachments
- Uses disposable paper dust bags for your convenience
- Light in weight and small in size, easy to carry and store

8720

Your Choice

\$24

No Trade-In Required

NO MONEY DOWN
on Sears Easy Payment Plan

Kenmore Rug Shampooer

- It's easy to shampoo all your carpets and area rugs
- Now scrub, wax, buff and polish all your floors

8040



Kenmore Upright Cleaners

Sears Low

\$29

- Revolving brush plus suction gets up lint, dirt and dust
- Handy throw-away paper dust bags for convenient cleaning
- Off-set design glides under furniture; handle cord storage

8400

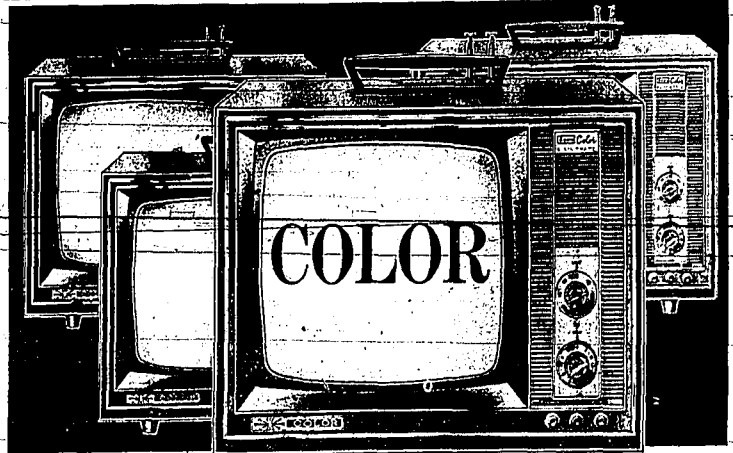

U-8161

SALE ENDS SATURDAY!

117-Sq.-In. Viewing Area Portable Color Television

\$299

No Trade-In Required

15-inch diagonally measured screen combined with a stylish cabinet to give you exciting color viewing plus true portability. It features a powerful 18,500-volt chassis for a constantly sharp picture and a big 3x5-in. oval speaker.

NO MONEY DOWN
on Sears Easy Payment Plan

Up to 3 FULL YEARS to Pay.
Ask Sears Salesman for Details

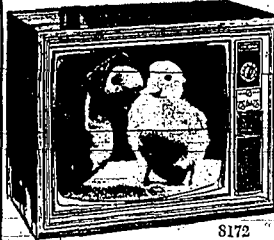

8172

295-Sq.-In. Viewing Area
Console Color TV

No Trade-In Required

\$429

Contemporary style cabinet has a giant 23-in. diagonally measured picture. Has Color-guard feature and bonded etched picture tube.



170-Sq.-In Viewing Area
Color TV

\$339

No Trade-In Required

18-in. diagonally measured screen for realistic color viewing. Sturdy walnut grained cabinet and no-glare screen.

7165



2820

Coldspot 15.8-Cu.-Ft. Upright Freezer

No Trade-In Required

\$179

- 15.8-cu.-ft. capacity holds over 550 lbs. of food
- Three spacious grille-type freezing shelves

NO MONEY DOWN
on Sears Easy Payment Plan
Up to 3 FULL YEARS to Pay
Ask Sears Salesman for Details

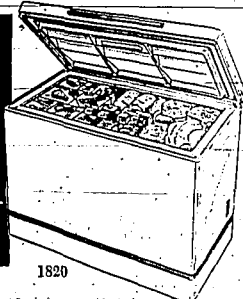

1820

Coldspot 15-Cu.-Ft. Chest Freezer

No Trade-In Required

\$179

- Holds over 520 pounds of food
- Total contact freezing
- Easy-lift lid with magnetic gasket

14.1-Cu.-Ft. Coldspot Refrigerator-Freezers

\$199

No Trade-In Required

- Spacious 11.0-Cu.-Ft. capacity bottom-mount refrigerator
- Top freezer section holds over 105 pounds of food
- Refrigerator features 2 full-width shelves plus crisper

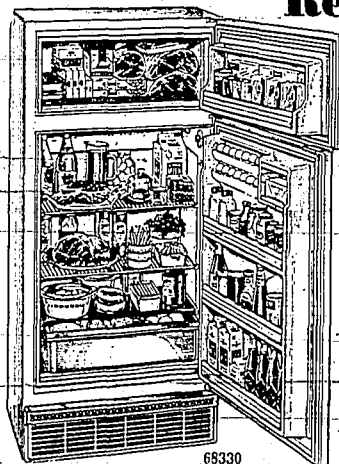

68330

Kenmore Washer and Dryer

Sears

SALE

Kenmore Automatic Washers

SALE ENDS SATURDAY

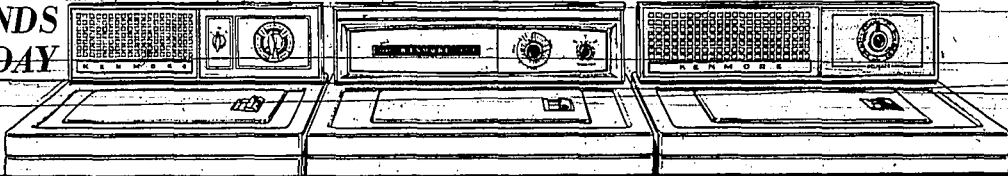

Your Choice

\$159

3 Cycles

3 Temperatures

2 Speeds

7411

8440

7350

Kenmore Compact 24-in. Automatic Washer Has 3 Cycles for All Fabrics

- 3 wash-rinse water temperatures
- Permanent Press-Wash 'n Wear cycle has water cool-down process to reduce spin-set wrinkles.
- 6-vane agitator loosens stubborn dirt
- Special Order

Washes Clothes Automatically At a Low, Low Price

- Choose Hot, Warm or Cold water temperatures
- Single-cycle operation
- Built-in lint filter
- 6-vane agitator loosens stubborn dirt

Kenmore 2-Speed Automatic Washer

- Washes, rinses, spin dries, shuts off
- Regular speed for vigorous washing action; slow speed gives gentle agitation to get dirt out of delicate fabrics
- 2 cycles for Regular and Delicate Fabrics

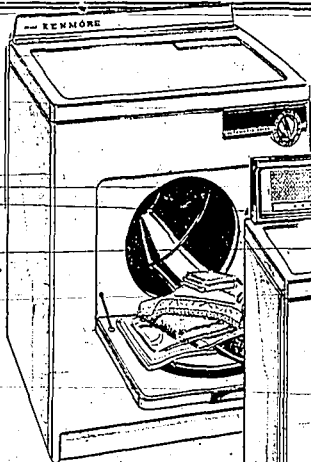

71740

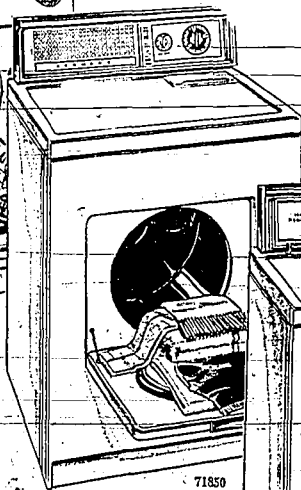

71850

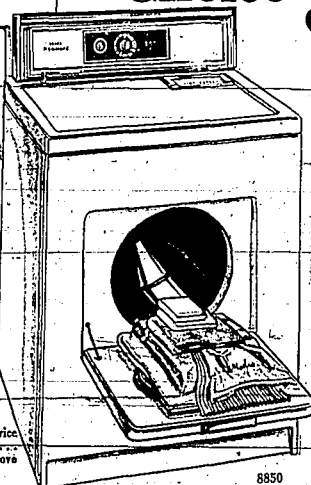

8850

Kenmore Dryers

Choose Two Temperatures, 3 Cycles, Permanent-Press Cycle Dryer

Your Choice

\$129

Kenmore 2-Temperature Gas Dryer

- Simple, durable and easy-to-operate dryer
- Use "Heat" for drying . . . "Air Only" for drying plastics such as wet rainwear and shower curtains
- Special Order

6-Temperature . . . 3-Cycle Electric Dryer

- 5 variable heat selections - warm to high
- "Air Only" setting for fluffing
- Top-mounted lint screen
- Load-A-Door folds down to make a shelf. #71850

3-Temperature . . . 2-Cycle Electric Dryer

- Just set cycle and temperature . . . your work is done
- Cycles for Regular and No-Iron fabrics
- Top-mounted lint screen #8850

NO MONEY DOWN
on Sears Easy Payment Plan
Up to 3 FULL YEARS to Pay
ASK Sears Salesman for Details



Sears Care Service Protects the Value of Your Appliance
Sears Highly-Trained Technicians Assure You Service Satisfaction with Personalized, Professional Care
We Service What We Sell, Wherever You Live or Move in the U.S.A.

Sears

Sears Days SALE

A SALE AS GREAT AS ITS NAME!

Lawn and Garden Care Sale

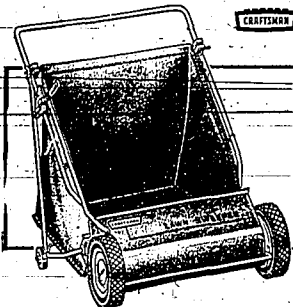

SAVE 6.02

Craftsman 25-in. Lawn Sweeper

Regular \$35.99 **29⁹⁷**

- Lift-out basket for easy clean-up; has big 6 1/2 bushel capacity.
- Wheels have fingertip adjusters with 13 positions, minus 1/4 to 2 1/2-in.

SALE ENDS SATURDAY

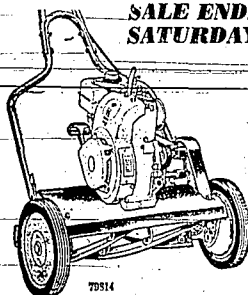

Sears 18-in. Power Reel Lawn Mower

69⁹⁹

Recoil start, 2-HP, 4-cycle engine powers this lawn mower to cut an 18-in. swath. The five-blade reel is on ball bearings for a smooth performance. Belts and chains are protected.

Save \$13⁰²

Sears 22-in. Push-Type Rotary Mowers

Regular \$72.99
4 Days Only

59⁹⁷

Mighty 9.0-cu. in., 3.5-HP engine has top-mounted, fast recoil starter. Choke, run, off-drive controls are placed on engine housing. Fingertip wheel adjusters change cutting height from 1 1/4 to 3 1/4 in. Non-sag loop handle avoids catching in bushes, makes storing easier. With right-side discharge chute and leaf mulcher. Strong 14-ga. steel housing.

Model 91184

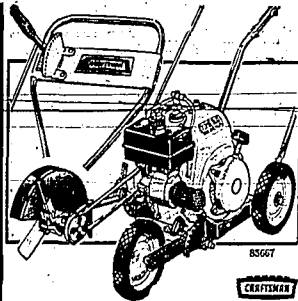

SAVE 10.02
Craftsman 3-Wheel Edger-Trimmer

Regular \$79.99 **69⁹⁷**
Push-type edger trimmer lets you adjust blade angle and cutting weight. Easy recoil-start engine for fast starts. Front wheel hops curb for better cut. Non-sag loop handle stores easier.

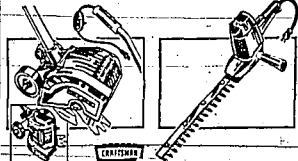

SAVE \$6.02 SAVE \$5.02
Craftsman 1/4-HP Edger-Trimmer **12-in. Electric Hedge Trimmers**

Regular \$31.99 **25⁹⁷** Regular \$21.99 **16⁹⁷**
Electric, 100% ball bearing motor. Cuts up to 1 1/2-in. deep. 110-120-V., 60-cycle AC. Single edge 16-tooth blade cuts 1 1/2-in. swaths. Fixed 120° handle. Ground blades.

SAVE \$14.98

Craftsman 18-Inch Power Reel Mower

Regular \$104.95

89⁹⁷

SALE ENDS SATURDAY

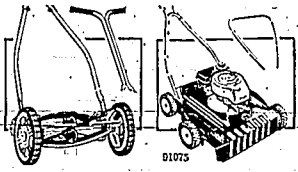

14-in. Hand Reel Lawn Mowers **Sears 20-in. Rotary Mower**

15⁹⁹ **32⁹⁹**

Four steel blades cut 1 1/2 to 1 1/2-in. high. Cast iron construction. Wood roller. 5.5-Cu.-In., 2.5-HP, engine has easy rope pull starter. Non-sag loop handle. 2-cycle.

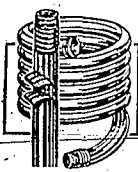

SAVE \$1.52
Craftsman 3/8-in. Plastic Hose
Regular \$8.49 **6⁹⁷**



3-Cubic-Foot Wheelbarrow
\$6⁹⁹

Finely balanced, tubular steel frame, 1-pc. steel tray. Topped 14-inch wheel.

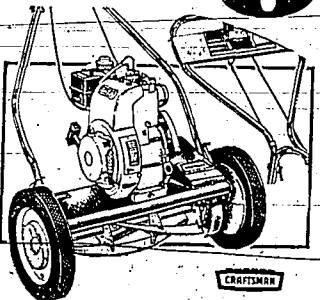

Delivers positive traction even in the thickest grass. Fuel primer gets gas into the engine quickly for fast, easy starts. Finger-tip lever control makes changing of cutting height fast and simple.



\$3.99
Craftsman Bow Rake
3.47

Bows, head, teeth 1-pc. forged steel.



SAVE \$1.02
Craftsman Round Point Shovels
Regular \$4.47 **4⁴⁷**

Our finest. Heat-treated 1 1/2-in. blade. Lightweight but has unusual strength.

SHOP AT SEARS AND SAVE!

SHOP MONDAY, THURSDAY and FRIDAY NIGHTS 'TIL 9 P.M.

Lawn and Garden Sale



**Giant 40-lb. Bag
6-10-4 Fertilizer**

Limited QUANTITY **2.97** BAG

Fortify your lawn and garden with this all-purpose fertilizer. A balanced plant food with all the necessary nutrients to assure vigorous, lush growth. Covers 2,000 sq. ft.

CHARGE IT
on Sears Revolving Charge



SAVE \$2.02

Sears 12-inch Redwood Tub
Regular \$3.99 **1.97**
Perfect decor indoors or in your patio. Heavy for your price plants. Sturdy, too.



SAVE 30%

Insecticide and Fungicide Sprays
Regular \$2.79 **1.97**
All-purpose product made to control insects, mites, diseases on trees, others.



SAVE \$4.02

Wipe-Out Garden Pests and Weeds, 2 1/2-Gal. Sprayers
Regular \$14.99 **10.97**

Open top design for easy cleaning and filling. Brass-finished components. Adjustable nozzle. Resists rust and corrosive action of chemicals. Easy to handle, use.

SAVE 3.02

\$7.99 Interior Latex Flat Paint

GUARANTEED 4 WAYS

4.97
Gallon



This smooth, dripless latex features quick, one-coat coverage—saves you time, energy and money. It dries to a completely washable, stain-resistant surface. Spots and smudges wipe easily away. Color won't fade with age. Backed by Sears exclusive 4-way guarantee. Buy now and save!

\$3.02 PRICE CUT

Latex Satin Semi-Gloss Wall 'N Trim Paint

Regular \$9.99 **6.97** Gallon

Ideal for kitchens, bathrooms, all woodwork and trim, furniture and toys. Fast one-coat coverage. Fade-resistant and scrubable. Easy to apply, dries in 1/2 hour. Soap, water clean-up.

16-Ft. Aluminum Extension Ladder

SAVE \$7.02
Regular \$24.99 **17.97**

Strong yet lightweight, this aluminum ladder will handle most jobs around the house. Has flat rungs for comfort. With rope and pulley; 3-in. rails, 1 1/2-in. rungs.

20 Ft. REG. \$31.99 \$23.97
24 Ft. REG. \$39.99 \$30.97

6-Ft. Aluminum Stepladder

SAVE \$6.02
Regular \$19.99 **13.97**

Easily handles most jobs around the house. Has big 3-in. steps; 9x11-in. pail shelf. Folds easily for storage.

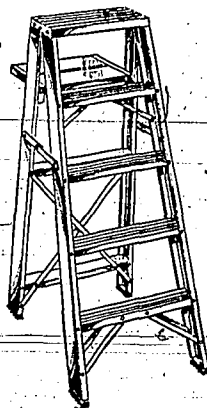

Fashion Lighting SALE

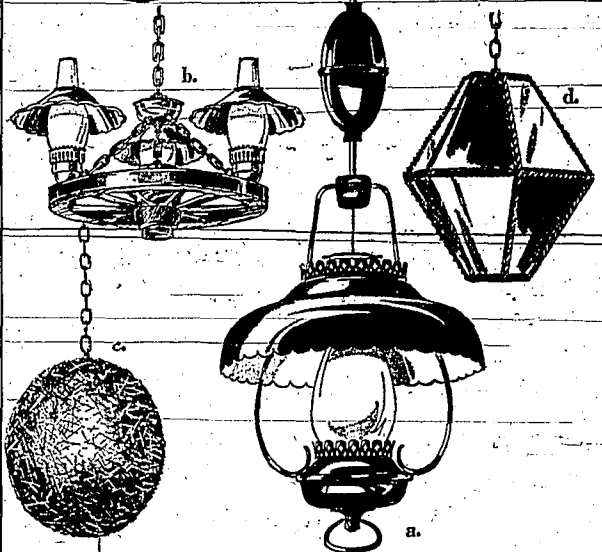

SAVE 7.02 to \$18.03

Swag Chain, Hanging Lamps

16.97 TO 34.97

- a. \$23.99 Four-lt. pulley fixture in black and white, 3-way switch 16.97
- b. \$42.99 Three-lt., 30-in. wagon wheel. Frosted glass chimneys 34.97
- c. \$38.00 One-lt. translucent 13-in. ball. Woven acrylic in purple, amber, blue, crystal or green 19.97
- d. \$32.99 One-lt., swag. Diamond-shaped fiberglass shade 24.97

NO MONEY DOWN on Sears Easy Payment Plan

Sturdy Vent-O-Top Ironing Tables

\$4.49

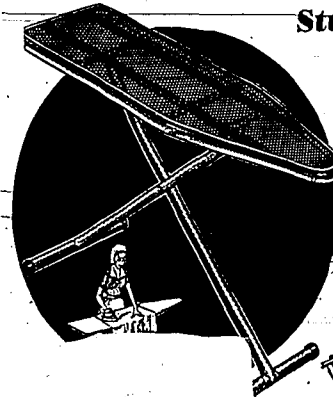

Now, iron quicker, easier, cooler! Sears open mesh ironing board lets steam through fast, cover-pad stays dry. Sturdy steel construction; rubber-tipped, non-scratching feet. Adjust the board to sitting or standing position... from comfortable, conveniently!

Teflon Ironing Board Cover.....



SAVE \$6.02

SALE ENDS SATURDAY

\$3.59 15-lb. Box Kenmore Detergent

SAVE **2.99**
60¢

Super-concentrated detergent that gets clothes truly clean, remarkably white and bright. Extra low suds prevent machine clogging. Economical because you use 1/2 cup less per wash.

Folding Aluminized Steel Outdoor Dryer

Regular **17.97**
\$23.99

A washday wonder... holds 5 average loads! So easy-to-clean plastic liner. Aluminized steel center post won't rust. It's extra sturdy and strong. Folds compactly for easy storage.

Sears

Sears Days SALE

A SALE AS GREAT AS ITS NAME!

Sears

QUALITY
INSTALLATION
BY
EXPERT
INSTALLERS

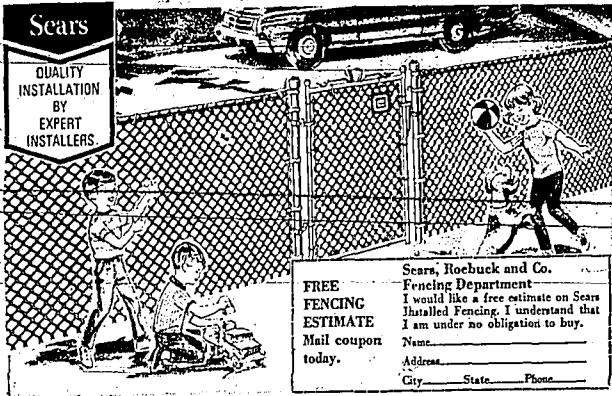

FREE
FENCING
ESTIMATE
Mail coupon
today.

Sears, Roebuck and Co.
Fencing Department
I would like a free estimate on Sears
Installed Fencing. I understand that
I am under no obligation to buy.
Name _____
Address _____
City _____ State _____ Phone _____

Chain Link Fence Material

Attractive, practical, strong. Sears laboratory tested chain link is galvanized after weaving to give you maximum rust protection. Use it all around your property, children and pets can play where you know they'll be safe. Includes: top rail, fabric, line posts, loop caps and tie wires. Terminal posts and gates extra.

Regular 96c Ft.

79^c
4 1/2 in. Thick
Complete
Material
Running Ft.

NO MONEY DOWN

Up To 5 Years to Pay on Sears Modernizing Credit Plan

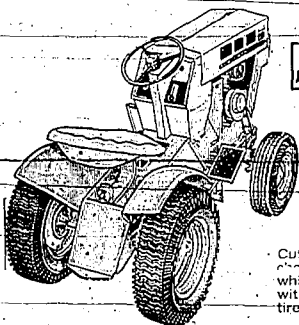

Sears New 10-HP.
Suburban Tractor

SAVE \$50.95

\$629⁰⁰

Regular \$679.99

Cut the time spent doing lawn and garden chores. Big 10-hp tractor mows, plows, hauls, while you enjoy the ride. Cast-iron engine with solid state ignition, over sizes turf-saver tires.

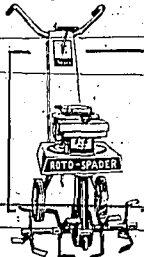

Sears 3 1/2-HP.
Roto Spader

109⁹⁷

Vertical drive spade offers power for your yard and garden chores. Engine weight over tines makes cutting and digging easier. Cuts a 22-inch wide swath.

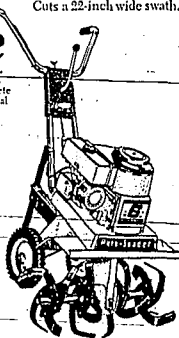

Powerful 6-HP.
Roto Spader

169⁹⁷

Sears deluxe spader gives the extra power and thrust needed for the big jobs.

With Power Reverse

Roofing Sale

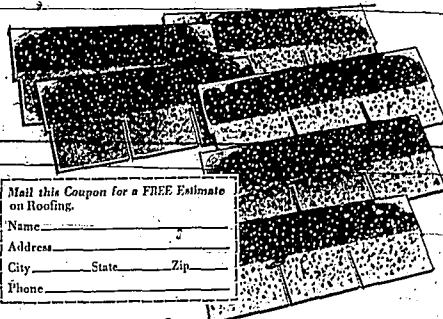

Mail this Coupon for a FREE Estimate on Roofing.

Name _____
Address _____
City _____ State _____ Zip _____
Phone _____

Deluxe 3-in-1 Asphalt Shingles

QUALITY
INSTALLATION
BY
EXPERT
INSTALLERS

15% OFF

Sears 3-in-1 asphalt shingles will add years of new beauty and weather protection to your home. Superior quality felt base is heavily saturated with asphalt, thickly coated again with asphalt and then with colorfast mineral granules. Shingles weigh 235-lbs. per 100 sq. ft.

No Monthly Payments Until October 1st on Sears Easy Payment Plan on Installed Roofing.

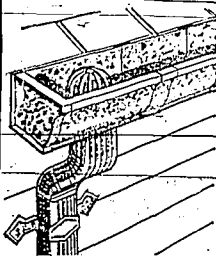

Galvanized Steel
Rain Gutting

10-Foot
Gutter

1²⁷
Regular \$1.99

This sturdy guttering is heavily galvanized to protect against rust and wear from all kinds of weather. Resists bending even when a ladder is leaned against it. In 10-ft. box type lengths.

NO MONEY DOWN on Sears Easy Payment Plan

Sears Central Air Conditioning

SAVE \$63

**\$492 - 28,000 BTU
Air Conditioner**

NO MONEY
DOWN Up To
3 Years To
Pay on Sears
Modernizing
Credit Plan

\$429

No more hot, sleepless nights with Sears central air conditioning. Your whole home is cooled and dehumidified when you need it... all at the touch of a button. Included high efficiency outdoor condenser, indoor cooling "A" coil, 25-ft. pre-charged refrigerant tubing plus heating, cooling thermostat.

SAVE \$73 Regular \$612 -
38,000 BTU System **\$539**

SAVE \$73 Regular \$662 -
42,000 BTU System **\$589**

SAVE \$63 Regular \$412.95 -
24,000 BTU with Slope Coil **\$349**

Plenty of FREE-StoreSide Parking

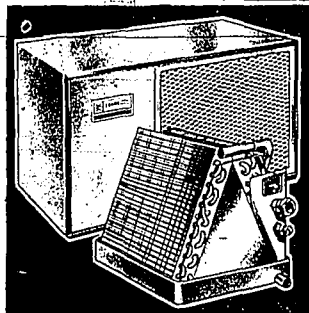

Services You can count on Sears for service anywhere you live in the U.S.A.

Installation Sears will arrange for quality installation by expert installers at a reasonable fee.



\$219.95 Electronic
Air Cleaner

SAVE \$30.95

\$189

Traps odors, dust, dirt and pollen—Your whole home looks and feels cleaner, air is fresher.



Kenmore Dishwashers

Convertible Front-
Load Dishwasher

SAVE \$39.98

189⁹⁷
Regular \$229.95

NO TRADE-
IN REQUIRED

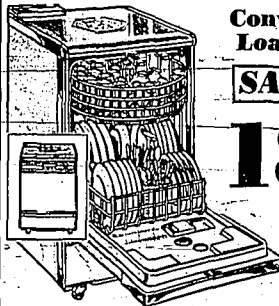

- Portable convenience... or custom-look built-in.
- 2 automatic cycles... "hot" 145 degree wash and rinse.
- Insulated... stays cool, quiet, holds heat inside.
- 2-level wash action permits true random loading.
- Handsomely styled in shaded avocado, white or shaded copertone to compliment your decor.

Kenmore Top-Loading
Portable Dishwasher

NO TRADE-
IN REQUIRED

99⁹⁷

- Porcelain-finish interior.
- Automatic one-cycle economy.
- Durable white enamel-finish.
- Kenmore quality... no pre-rinse.

NO MONEY DOWN
on Sears Easy Payment Plan

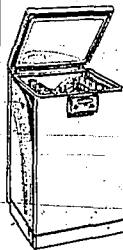

Sears

Spring Automotive and Recreation

SALE

\$169.95 Auto Air Conditioner

\$147

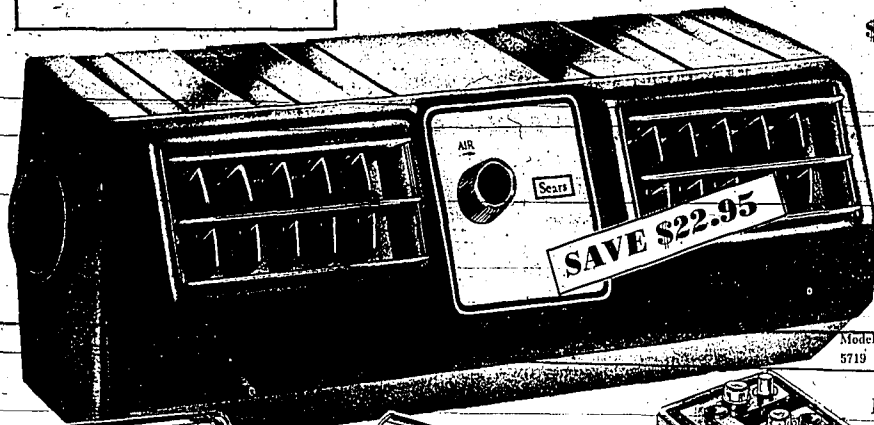

Attention-all you drivers who would rather sweat than switch! How many times have you said to yourself: "Sure Auto Air Condition's nice, but it costs too much." Look again. Now you can enjoy hot-weather protection for an average cost of less than \$1.30 per day, May through September. You'll travel cool and dry with a Sears Air Conditioner.

Model 5719

Installation Arranged at Your Convenience

NO MONEY DOWN on Sears Easy Payment Plan

6-Volt Battery

Guaranteed 12 Months

Regular \$9.99

SAVE \$2.02 **797**

NO TRADE REQUIRED GROUP 1

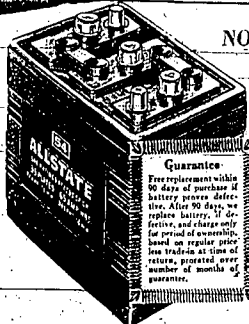

Guarantee:
Free replacement within 90 days of purchase if battery proves defective. After 90 days, we replace battery, if defective, and charge only cost of freight. Based on regular price less trade-in allowance of return, prorated over number of months of guarantee.

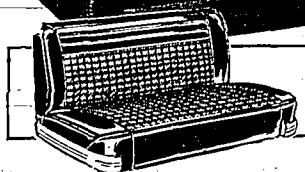

\$21.95 Woven Seat Cover

SAVE \$3.98 **1797**

We Can Fit Most Any Car At This Low Price!

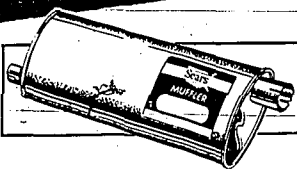

\$8.98 Double Wall Muffler

SAVE \$2.51 **647**

Fits 1954-'64 Chev., 1960-'66 Dodge, Valiant, 1960-'63 Falcon and Comet.

Regular \$9.98 Muffler fits 1962-'65 Dodge, Plymouth, 1960-'65 Ford, Merc., Fairlane, 1962-'67 Chevy II, Chevelle.

747

Dress up your car's interior with these handsome seat covers. Woven plastic back-rest and cushion for easier riding comfort. Durable. Installation Available.

\$12.99 12-Volt Battery

Guaranteed **1097**

18 Months GROUP 2A

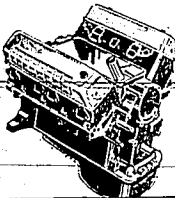

Complete Remanufactured Engine

Expert Low Cost Installation Available
NO MONEY DOWN
on Sears Easy Payment Plan

Clip This Coupon
25% OFF
Any Complete 6 or 8 Cylinder Engine
One Coupon Per Customer
Expires April 29th

SALE ENDS SATURDAY

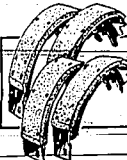

\$6.99 4 Heavy Duty Brake Shoes

SAVE \$1.82 **517** each

Precision dual-friction linings give effective, balanced braking action. Resist heat fade.



Sears Regular \$4.99 Shock Absorbers

SAVE \$1.52 **347**

Sears shock absorbers provide equal to original equipment performance. Get a seal.

Make Sears Your Recreation Headquarters!

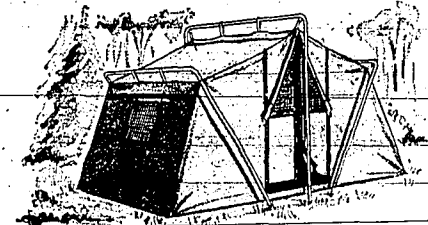

*\$69.99 8x11-Ft. Highway Tent

SAVE \$10
5997

After a long day on the road you'll like the way this tent sets up in a hurry and stands up strong and sturdy in almost any kind of weather. The all-aluminum frame is lightweight for easy handling; stands completely outside the tent for more usable inside space.

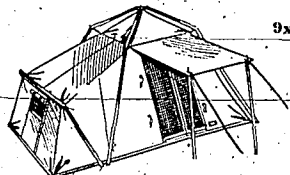

9x12-Ft. Sideroom Tent

SAVE \$20.02 Regular \$89.99 **6997**

Fast-pitching outside aluminum frame, nylon screen windows, 6-ft. center cave height, 4-ft. sideroom eaves. 6.74-oz. cotton drill. Green color.

SALE ENDS SATURDAY

CHARGE IT!
on Sears Revolving Charge



4-lb. Vycron® Fill Sleeping Bag

Multi-layered bag keeps you more comfortable. 100% cotton duck cover, cotton liner. 33x75-in. size, single mattress pocket, separating zipper. Green.

1397

Plenty of FREE Storeside Parking



For Him or Her... Signature 11-Pc. Golf Outfit

3897

Ideal for beginners, fine enough for experienced golfers! Includes 3, 5, 7, and 9 irons; putter; 1-and 3 woods; package of three golf balls; bag of 10 tees; vinyl stretch glove; black golf bag for men or red bag for women.

NO MONEY DOWN
on Sears Easy Payment Plan

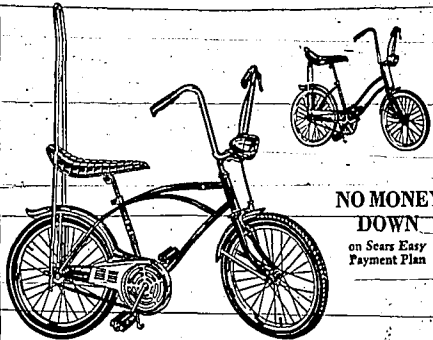

Fully Equipped and Rarin' to Rally Boys' and Girls' Spyder Bikes

NO MONEY DOWN
on Sears Easy Payment Plan

- 20x2.125-in. Road gripping rear tire
- Two cell headlight and 3-in. reflector
- Coaster brake with front hand brake

Boys' and girls' spyder bike sport pack gear includes color coordinated outfit, seats and grips, fitted chrome-plated fenders, power grip handlebars and 4-position adjustable seat. See them today.

Your Choice

3997 Each



\$6.99 Little League Baseball Shoes

Black vinyl uppers with full-grain leather tips for rugged wear. Long-wearing hard rubber soles with molded spikes. "D" width in full sizes 3 to 10.

597



Steerhide Fielders Glove

4 1/2" shaped heel for better feel and glove balance. All lacing of tough rawhide. **447**

Sears

3 HOUR SALE

THURSDAY NIGHT 6 P.M. TO 9 P.M.

Three-Hour Bargains Priced So Low That We Can't Offer Them For Longer Than Three Hours!

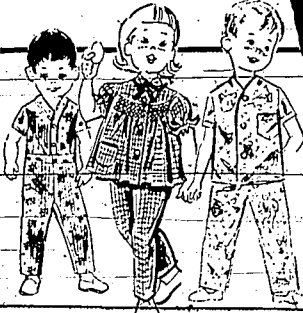

Children's Sleepers

100% cotton sleepwear for the sample set. Two-piece sleepers. Sizes 1 to 4. Limited Quantity.

97¢

CHARGE IT on Sears Revolving Charge

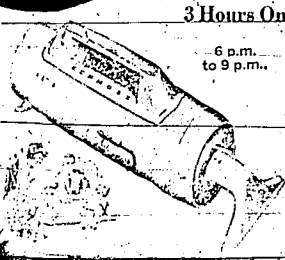

3 Hours Only

6 p.m. to 9 p.m.

Kenmore Hand Vacuum

Great for small cleaning chores. For carpets, upholstery. Uses paper dust bags. Limited Quantity.

8⁹⁷

CHARGE IT on Sears Revolving Charge

Men's Sweatshirts

SAVE 16%

1.66

THURSDAY 6 p.m. to 9 p.m.

\$1.99 short-sleeve sweatshirts with ready-for-action raglan sleeves. Soft cotton fleece. Rib knit collar, waist and cuff. Small to extra large.



CHARGE IT on Sears Revolving Charge

THURSDAY EVENING

6 p.m. to 9 p.m.



49¢ Stair Treads

Heavy rubber treads with nosing anchors firmly in front of stair for extra safety. Black or Brown.

49⁷¢

CHARGE IT on Sears Revolving Charge

Thursday Evening

Women's Cotton Sateen SHIRTS

1.97

Ideal daywear for the at-home woman. Easy-care cotton sateen shirts. Rush in while limited quantity lasts. Small to large sizes.



Gladiolus Bulbs

Lovely flowers for your yard and garden. Plant now for early blooming. 1 1/2-in. bulbs.

3[¢]

CHARGE IT on Sears Revolving Charge

SAVE \$1.03 Girls' \$4 Stretch Jeans

3 Hours Only **2.97**

Every girl in the action set needs these jeans. Pick out your favorite color. Cotton and nylon stretch denim in sizes 7-14.

Girls' Knit Striped Tops

1.17

Crew-neck striped cotton knit tops in wide choice of colors. Sizes 7-14. Don't miss.



Shower Curtains

6 p.m. to 9 p.m. THURSDAY NIGHT

1.27

Shower curtains to "roll-up" your bath. All in wipe-clean vinyl plastic that won't burden or crack. Completely colarfast.



CHARGE IT on Sears Revolving Charge

3-DAY TIRE SALE

3-YEAR GUARANTEE

Free ALLSTATE Tire Mounting and Rotation



4-Ply Nylon Cord Supertred Tires

1.835

6.50x13 Tubeless Blackwall Plus Tax and Your Old Tire

- ALLSTATE Supertred... built with rugged 4-ply nylon cord
- Contour safety shoulders give you improved steering
- Guaranteed by Sears to wear for a full 36 months

ALL STATE Supertred Tubeless Blackwall	Regular Price With Your Old Tire	Sale Price With Your Old Tire	Fed. Exc. Tax
6.50x13	23.95	19.35	1.81
7.35x14	26.95	21.75	2.06
7.75x14	28.95	22.35	2.19
8.25x14	30.95	24.95	2.35
5.60x15	23.95	19.55	1.74
7.75x15	28.95	23.35	2.21

Whitewalls, on Sale at Similar Savings

Large Selection of Other Sizes Also on Sale!

NO MONEY DOWN

on Sears Easy Payment Plan

ALLSTATE Passenger Tire Guarantee

Tread Life Guarantee
Guaranteed against all full coverage of the tread from normal wear and tear in material of workmanship.

For How Long? For the life of the original tread.

What Sears Will Do: If you notify us within 90 days of the date of failure, in exchange for the tire, we will give you the amount of current regular selling price plus a \$1.00 allowance.

Tread Wear-Out Guarantee
Guaranteed against Tread wear-out.

For How Long? The number of months specified.

What Sears Will Do: In exchange for the tire, replace it, charging the current regular selling price plus Federal Excise Tax and the following allowance:

Months Guaranteed Allowance
12 to 24 \$1.00
25 to 36 \$2.00

Heavy-Duty Panel, Pickup, Camper Tires

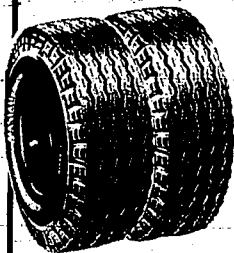

ON SALE!
6.00x16 Tube-Type Blackwall Tires

16⁸⁵ Plus \$2.78 F.E.T.

Century "21" 6-ply rated nylon cord small truck tires. No trade-in required. Large selection of sizes available.

SALE ENDS SATURDAY!

SUPPLEMENT TO THE

Times ~~and~~ News

WEDNESDAY, APRIL 17, 1968

SALE PRICES END
SATURDAY, APRIL 20, 1968

Sears

Home Fashions SALE

*Sears-Blueprints-Fashion
for Your Home...with Prices
Scaled to Fit Small Budgets*

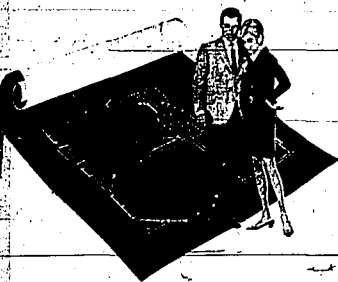

NO MONEY DOWN on Sears Easy Payment Plan

SAVE *40.07 to *69.07 on Designer Sofas **199⁸⁸**

Designer styling, meticulous tailoring and luxurious comfort . . . at sensational low prices. Choose the charm of authentic Colonial styling, the elegance of Traditional or the sleek look of the Contemporary style. Sofa fabrics are treated to resist stains.

199⁸⁸
to
279⁸⁸

Regular \$259.96 to \$329.96



SAVE
14%

Mediterranean or Colonial Tables

Cocktail tables, end tables, lamp and step tables . . . in solid maple. Colonial styling or rich peach finished hardwood Mediterranean style. **Your Choice** **\$34** Regular \$39.95 Each

Shop at Sears and Save



Twin Falls, Idaho

403 Main Ave. W. | Phone 733-0521

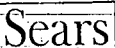

STORE HOURS

Tues., Wed., Thursday. Mon., Fri. 9:30 a.m. - 6 p.m. 9:30 a.m. - 9 p.m.
Saturday - 9:30 a.m. - 6 p.m.

SEARS, ROEBUCK AND CO.
Satisfaction Guaranteed or Your Money Back

Satisfaction Guaranteed or Your Money Back

Sears Our Largest Dinnerware SALE

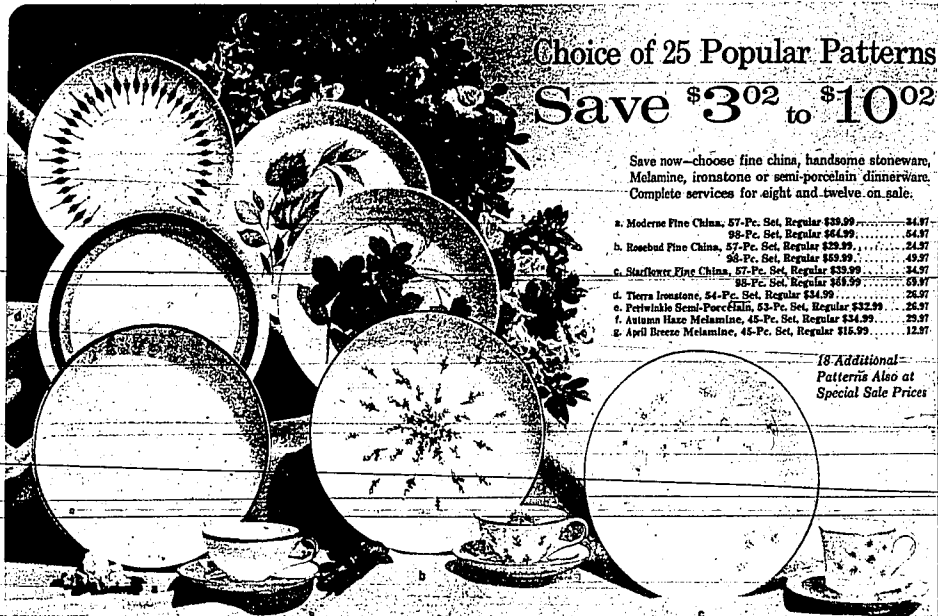

Choice of 25 Popular Patterns

Save \$3⁰² to \$10⁰²

Save now—choose fine china, handsome stoneware, Melamine, ironstone or semi-porcelain dinnerware. Complete services for eight and twelve on sale.

- a. Moderne Fine China, 57-Pc. Set, Regular \$39.99 \$4.97
- 98-Pc. Set, Regular \$64.99 \$4.97
- b. Roosevelt Fine China, 57-Pc. Set, Regular \$29.99 \$4.97
- 98-Pc. Set, Regular \$59.99 \$4.97
- c. Stafforder Edge China, 57-Pc. Set, Regular \$39.99 \$4.97
- 98-Pc. Set, Regular \$69.99 \$9.97
- d. Tierra Ironstone, 54-Pc. Set, Regular \$54.99 \$6.97
- e. Festivals Semi-Porcelain, 52-Pc. Set, Regular \$32.99 \$4.97
- f. Autumn Haze Melamine, 45-Pc. Set, Regular \$34.99 \$2.97
- g. April Breeze Melamine, 45-Pc. Set, Regular \$16.99 \$2.97

18 Additional Patterns Also at Special Sale Prices

The Coordinated Look in Decorator Lamps

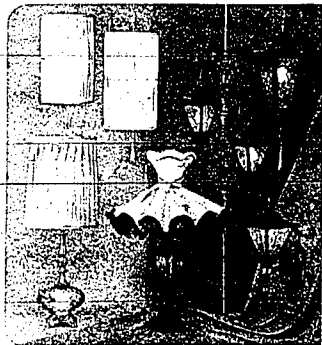

Classic Collection with Beautiful Pleated Shades

Choose white or beige shade on chain and wall lamps. Table lamp has amber or green glass.
 \$24.99 Table Lamp...\$18
 \$14.99 Chain Lamp...\$11
 \$14.99 Wall Lamp...\$11

The Early American Country Look

Blending the warmth of Salem finished hand-crafted wood with amber glass for beauty.
 \$54.99 Table Lamp...\$42
 \$29.99 Pole Lamp...\$24
 \$21.99 Chain Lamp...\$18
 \$19.99 Wall Lamp...\$28

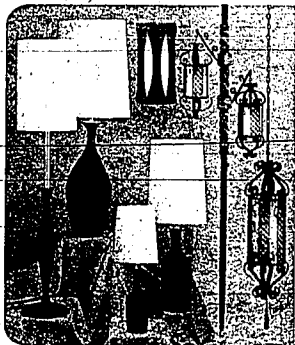

Contemporary Cork Collection

The clean textured look of cork and wood. Ideal for the living room, den, office or bedroom.
 \$14.99 Table Lamp...\$18
 \$49.99 Table Lamp with full range dimmer-control switch...\$38
 \$14.99 Boudoir Lamp \$12
 \$21.99 Floor Lamp...\$28
 \$21.99 Chain Lamp...\$28

Spanish Inspired Fashion Lamps

Shades of Old Spain... black iron scrollwork blended with amber translucent panels.
 \$39.99 Chain Lamp...\$28
 \$39.99 Pole Lamp...\$28

Sears Rugs for Every Taste... Every Budget

a. Festive Floral Decorator Rugs

Luxuriously deep, dense rug of hand-hooked rayon pile will bring warmth and vibrance to your home. Decorative floral motif in 4 gay color schemes resist fading. In 4 other sizes, round and oblong shapes.

Regular Low Price
89⁹⁹
62x104 in.

b. SAVE \$15.11

Colonial Tubular Braided Oval Rugs

Colonial charm and modern practicality are paired in this reversible rug. 80% acrylic, 20% modacrylic outer surface is easy to care for; long wearing. 6 colors, 8 other sizes. Other Colonial Rugs as low as \$5.88

Regular \$49.99
54⁸⁸
102x138 in.

c. SAVE \$10.11

Casual Textured Tweed Area Rugs

Durable nylon pile rug with cushion backing is ideally suited for homemakers that want both beauty and economy. Nubby textured pile resists soil, stains... spot cleans easily. In 8 tweed mixes, 4 other sizes.

Regular \$59.99
49⁸⁸
8x12 ft.

d. SAVE on Bold-Toned Accent Rugs

Add a colorful finishing touch to any room with these striped accent rugs. Easy-care rayon and acetate pile with skid-resistant backing is machine washable. Choose from 10 radiant colors... 4 other sizes.

Regular \$4.49
3⁷⁷
21x36 in.

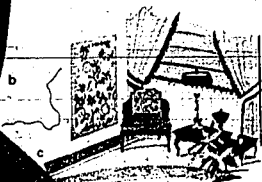

Consider hanging a decorative rug on your wall for an interesting focal point... an attractive accent.

NO MONEY DOWN on Sears Easy Payment Plan

PHONE SEARS to Order These Beautiful Decorator Rugs

Sears

Beautiful Bedrooms at Big Savings

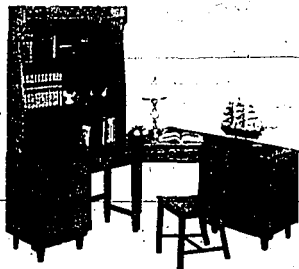

Student Desk,
Regular \$89.95...**69.88**

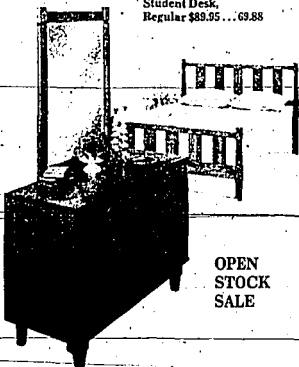

**OPEN
STOCK
SALE**

Rugged Ranchero Oak

- Single Dresser Base
- Bachelor Chest
- Panel Bed
- 42" Twin, Deck
- Corner Desk

Your Choice

69⁸⁸

Regular \$74.95 to \$94.95

Warm brown tone solid oak tops and fronts... with hammered metal hardware. All beds are solid oak. Dust proof, dovetailed drawers.

Chair, Regular \$29.95... 27.88
Single Dresser Mirror... \$30



4-Drawer Chair, Regular \$79.95... \$6.88
Twin with Bath Bed, Regular \$79.95... \$6.88
6-Drawer Double Dresser Base, Regular \$124.95... \$89.88
2-Drawer Night Stand, Regular \$34.95... \$4.88

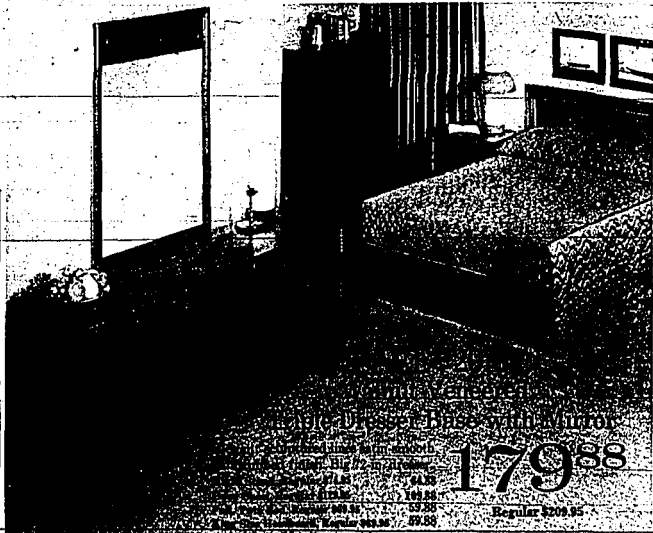

Elegant 3-Pc. Suite with Mirror
179⁸⁸
Regular \$209.95

All Mirrors are Plate Glass



SAVE \$35.01
Elegant 3-Pc. Suite with
Triple Dresser

Exquisite contemporary lines crafted of satin-smooth walnut veneers. Includes 60-in. triple dresser with mirror, chest and full or twin bed. Night Stand... **199⁸⁸**
Regular \$234.89

ADOWN on Sears Easy Payment Plan

Regular \$234.89

Sears Sleep Shop Favorites Now On Sale



SAVE \$10.07
SEARS-O-PEDIC
 Mattress Scientifically
 Built for Extra Support

Regular \$74.95
 Twin or Full **64⁸⁸**

Matching Posture-Mate
 Foundation, Twin or Full
 Regular \$74.95 **64.88**

Designed for deep, firm support with luxurious quilt-top comfort: 897 coils in full and 615 in twin. Crush-resistant borders and no-sag corners. Rayon damask cover.

Our Salem Maple Finish
 Colonial Style Headboards
 Twin Size, Regular \$19.95 14.95
 Full Size, Regular \$24.95 19.95
 Queen Size, Regular \$29.95 24.95
 King Size, Regular \$39.95 34.95

SAVE \$26.07, 2-Pc. King Set: Mattress Plus 2 Foundation Units
 Regular \$79.95 **53.88**

Metal Bedframes,
 Regular \$9.95 **6.99**

SAVE \$26.07, 2-Pc. Queen-Set: Mattress Plus Foundation Unit
 Regular \$74.95 **48.88**



SAVE \$19.97
8-Pc. Bunk Bed Outfits

Artistically crafted of maple finished hardwood. Includes 2 beds, 2 Serofoam polyurethane bunk units, 2 pair rails, ladder, guard rail.

9988
 Regular \$119.85

NO MONEY DOWN on Sears Easy Payment Plan

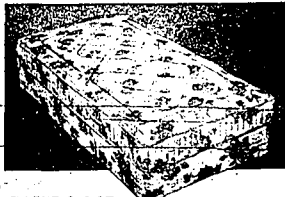

SAVE \$10.07
432-Coil Innerspring Mattresses

Firm innerspring construction - no-sag borders. Luxurious scroll quilted cover. 432 coils in full size and 297 coils in twin. Matching Foundation Unit, Regular \$49.95 **39.88**

3988
 Regular \$49.95
 Full or Twin



SAVE \$10.07
6-in. Foam Latex Mattresses

Sears exclusive dimple-top foam latex won't sag... supports you firmly. Luxurious quilted top and floral print rayon cover. Matching Foundation Unit, Regular \$79.95 **69.88**

6988
 Regular \$79.95
 Full or Twin

Sale! Draperies, Curtains and Spreads

Save \$3.02 to \$5.02 on "Petit Plume" Thermogard Insulated Draperies

There are several sides to this drapery story. First of all there's the design... rayon and cotton jacquard-woven for a two-tone damask look. Then, too, the fabric is Perma-Smooth... you don't really need an iron to keep it looking lovely. But best of all, this drapery is self-lined... a coating of 100% acrylic is permanently bonded to the back to help insulate your rooms. Green, gold, or white.

Regular \$10.99

797
50x84 inches

Regular \$9.99 50x54-in...	6.97	Regular \$21.99 76x84-in...	18.97
Regular \$17.99 76x54-in...	14.97	Regular \$29.99 100x84-in...	25.97
Regular \$23.99 100x54-in...	18.97	Regular \$34.99 125x84-in...	29.97
Regular \$39.99 150x84-in...		34.97	

"Sutton" Bedspreads

Sears Regular
Low Price

999
Twin
or Full

Create a new mood in your bedroom with a luxurious "Sutton" quilted-to-the-floor bedspread. Acetate satin in iridescent colors. With puffy polyester and Estron[®] fiberfill.

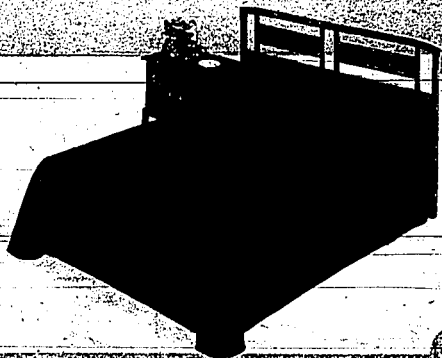

Sheer Dacron[®] Ninon Panels in Jewel-Tone Colors

Smooth and Sheer
When Used Alone

Regular \$1.99

Or Use Them
Under Draperies

97
62x81-in.

Add richness to your windows... no matter how you use them. Dacron[®] poly... machine washable, no-iron Gold... this makes...

Extra Wide (white only)	
Panel 22x81-in.	1.97
Panel 32x81-in.	1.97
Panel 42x81-in.	1.97

SAVE \$1.00 Non-Slip "Regency" Throws

Regular \$1.99

497
70x81-in.

Heavyweight fabric. Gold, brown, olive, blue, melon.
\$1.99 70x81-in... 7.97
\$11.99 76x124-in... 11.97

SAVE on "Miles" Velveton Pillows

Regular \$1.99

Color...
100%...
Anti...

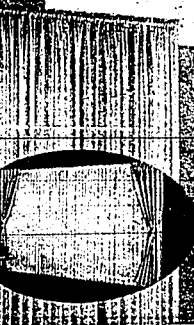

Sears SALE! Fashionables for Bed and Bath

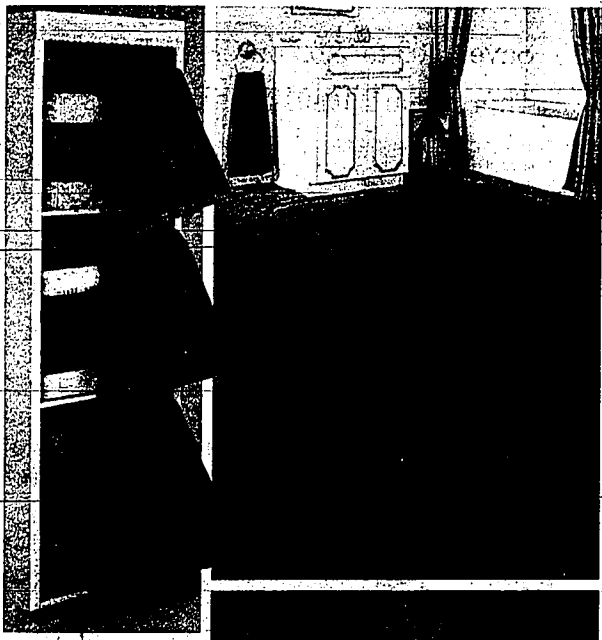

DuPont Nylon Bath-Carpeting **13⁹⁷**
 Regular \$17.99 4x6 ft.

Regular \$4.49 Nylon Pile Bath Rugs, 24x36-in. Size **347**

Luxury that's deep enough to sink your toes into! Scott Securi-Tee® polyurethane foam backing for extra cushion comfort and skid resistance. Machine washable, dryable. Easy to install! Just measure, cut with scissors, and fit.

5x8-ft. Carpeting, Regular \$21.99 17.97
 5x8-ft. Carpeting, Regular \$29.99 24.97
 27x48-in. Bath Rug, Regular \$6.49 4.97
 Standard Lid Cover, Regular \$2.49 1.87
 2-Piece Tank Set, Regular \$4.99 3.97

©1981, Product of Scott Paper Company

21% Off on Super-Absorbent Bath Towels

Regular \$2 Bath Towel

157

Towels styled with fashion flair to perk up your bath! Extra fluffy, with fringed ends, pucker-proof borders.

Hand Towel, Regular \$1.20, 97c Washcloth, Regular 60c, 47c
 Fingertip Towel, Regular 70c, 57c

Stock up and Save Now on Fashion Sheets

Regular \$3.49
 Floral Percale

314
 Twin Flat or Fitted

Bring the freshness of Spring to your bedroom year 'round with colorful fashion sheets from Sears. Delicate pastels, perky prints, dainty florals. Fine-quality smooth-combed-cotton-percale. Elasto-Fit-corners for easy bed-making. Choice of flat or fitted.

2/\$2.69 Pillowcases, 2/2.44 \$4.49 Full Size 4.14

Solid Pastel Percale	2.77	Feltt Point Percale	
\$2.98 Twin Size	2.97	\$3.49 Twin Size	3.14
\$3.29 Full Size		\$4.49 Full Size	4.14
2/\$1.69 Pillowcases	2/1.57	2/\$2.69 Pillowcases	2/2.44

Sears

MONEY SAVERS

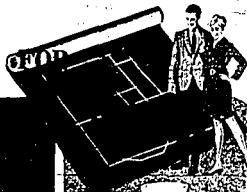

Ballerina Styled
Lamp Shades

Sears Regular \$24.95
Low Price **19⁹⁵**
Nylon fabric lamp shade gives the enhance any bedroom decor. White or pastel.



Save \$4.95 on Unupainted
6-Drawer Dresser
Regular \$24.95
Low Price **19⁹⁹**

Authentic Colonial style in smoothly grained knotty pine. 24 x 17 1/2 x 23 in. high.
\$27.95 Unpainted Dresser \$22.99



Save \$3.95 on Unupainted
6-Drawer Dresser
Regular \$27.95
Low Price **19⁹⁸**
Sturdy, clean, easy to finish. 24 x 17 1/2 x 23 in. high.
\$34.95 16-Drawer Style \$30.99



Save \$17.96 on Full-Size Cribs
Regular \$38.95
Low Price **21⁹⁹**

Down on Sears Easy Payment Plan



Heavy-Gauge Vinyl
Carpet Runners

Sears Regular \$2.00
Low Price **1⁵⁰**

Protect carpeting with these acid and puncture-resistant runners. Clear, Gold & colors.



3x58-In. Rugs in Seven Bright Colors

Sears Regular \$2.00
Low Price **1⁴⁷**

Washable rayon and cotton rug has diamond pattern.
36x58-In.Rug 2.47



Flagstone Pattern Vinyl Asbestos Tile

Sears Regular \$2.00
Low Price **5⁰**

Quality 9x9-in. tile at budget prices. Choose smoothly enameled pattern in 3 colors.



Easy-Care Vinyl Window Shades

Sears Regular \$2.00
Low Price **99⁰⁰**

So easy to keep fresh looking - wipe clean. Won't crack, ravel. White. 37 1/4 in. x 6 ft.



Decorator Pillows in Favorite Accent Colors

Sears Regular \$2.00
Low Price **99⁰⁰**

Add beautiful antique rayon 24-in. tufted pillow to your decor. Kappa Blue.

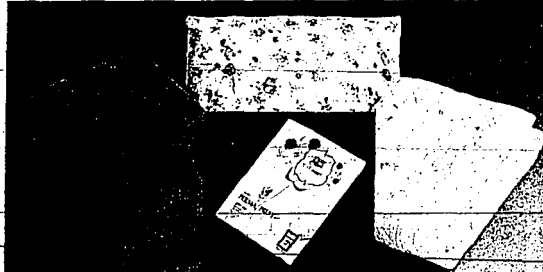

Any 2 for 3

Down-Filled Pillows
Regular \$3.99 Each - Luxuriously comfortable. Down polyester. Non-allergic. Seal-Gard treated. Floral cotton cover, neat corded edges.

Cozy Sheet Blanket
Regular \$3.99 Each - An extra-warm sheet in winter, lightweight blanket in summer. Softly-napped cotton.

PERMA-PREST® Sheets
Regular \$3.19 Each Twin. Just wash, tumble dry. Polyester, cotton percale.
Regular \$4.19 Each, Full Size 3 for 7.55

Mattress Pads
Regular \$3.29 Each Twin. Reinforced cotton cover, nylon-cotton fill. Band.
Regular \$4.29 Full, Band Style 3.55
Regular \$4.29 Twin, Fitted Style 3.55
Regular \$5.29 Full, Fitted Style 4.55



Your Choice of Handsome

GIFTWARE

Sears Regular \$24.95
Low Price **88⁰⁰**

Over a hundred unique gift ideas for bridge parties, birthdays or "thank you's". There's everything from salt and pepper sets to vases, compotes, goblets and brassy mixers. Hurry in now for your best selection.

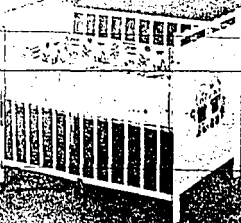

SAVE \$7.96 on Full-Size Cribs

Regular \$38.95
Low Price **21⁹⁹**

Double-dropside crib has toothed rails and heavy-duty casters. Includes mattress with quilted natural finish. 6 1/2 in. Crib Mattress. Regular \$12.99. \$10.99. 4 in. Crib Mattress. Regular \$21.99. \$19.99. Down. 6 1/2 in. Bed Size \$21.99. \$19.99.