

Inside today

Hemingway: Jack scores success - D1

Times-News Classifieds Garage Sale Special: 5 lines 2 days \$7 CALL 733-0626

10 27 86 195 KALVAR CORP 3522 S 3RD E SALT LAKE CITY UT 84115

helpful - B1

The Times-News

81st year, No. 171

Twin Falls, Idaho

Friday, June 20, 1986

Copyright 1986 Magic Valley Newspapers Inc.

25¢

Reagan says Soviets move on arms control

By SUSANNE M. SCHAFER The Associated Press

GLASSBORO, N.J. — President Reagan, in his first formal response to Soviet leader Mikhail Gorbachev's latest arms control offer, said Thursday "it appears that the Soviets have begun to make a serious effort" toward negotiating an agreement.

Reagan, in a speech delivered at a New Jersey high school near the site of a 1967 U.S.-Soviet summit, said the Soviet offer cannot be accepted without change, but could be the basis for serious negotiations.

"Until recently, the Soviet response has been disappointing in a number of ways," Reagan said. But citing what he called "fresh developments" in several areas, the

Stick to SALT, House resolution advises

By TIM AHERN The Associated Press

WASHINGTON — The House voted approval Thursday of a resolution urging continued U.S. adherence to SALT II, the unratified nuclear arms control treaty that President Reagan says he will not use in the future to guide decisions on weapons deployment.

The Democratic-controlled House

approved the non-binding resolution on a 256-145 vote after five hours of debate and following 227-187 defeat of a Republican-backed proposal that would have basically endorsed Reagan's decision.

Before final passage, the House voted 406-9 approval of another Republican-sponsored proposal saying the chamber supports the efforts of U.S. arms control negotiators in Geneva to reduce superpower nu-

clear arsenals.

On the final vote, 219 Democrats and 37 Republicans voted for the resolution. It was opposed by 17 Democrats and 123 Republicans.

Idaho's congressmen, Democrat Richard Stallings and Republican Larry Craig, both cast "no" votes.

At about the same time, the Republican-controlled Senate Armed Services Committee voted 109-5 to support the resolution.

See SALT on Page A2

come of the 1967 summit between President Lyndon B. Johnson and Soviet Premier Alexei Kosygin at nearby Glassboro State College.

"I have come here today to say that the Glassboro Summit was not enough, that indeed the Geneva Summit was not enough — that talk alone, in short, is not enough. I have come here to invite Mr. Gorbachev to join me in taking action — action in the name of peace," Reagan said.

The president noted that he recently wrote Gorbachev to press for high-level talks on summit preparations. No response has been received. White House officials have said.

The school gymnasium was jammed to its capacity of 1,200 people and a crowd gathered outside listened to

the president's speech over a public address system.

After the president spoke, he shook each senior by the hand as the student came forward to receive his or her diploma. Some of the girls gave him a kiss on the cheek.

The president was presented with a varsity jacket in maroon and gold, the school colors, and an honorary diploma. He said he was grateful for the diploma, but quipped, "I have always nursed a sense of guilt that the first one I received was honorary."

Before boarding his Marine Corps helicopter for the flight back to Washington, Reagan told the crowd of several thousand on a grassy field outside that his trip to Glassboro was "a lesson in the greatness and

See REAGAN on Page A2

Of the Soviet offer made in Geneva, Reagan said, "We cannot accept these particular proposals without change, but it appears that

the Soviets have begun to make a serious effort.

In his speech to graduating seniors, Reagan noted that little had

Senate votes partial sales tax deduction

By JIM LUTHER The Associated Press

WASHINGTON — The Senate on Thursday approved a partial deduction for some state and local sales taxes and agreed to a final vote next week on a radical plan for overhauling the federal income tax.

To help pay for the sales tax amnesty, the Senate agreed to require that every person age 5 or older who is claimed as a dependent have a Social Security card, in an effort to slow tax cheating by falsely claiming exemptions.

"We're in the home stretch," Majority Leader Bob Dole, R-Kan., said near the end of the 10th day of debate on the bill. A few hours earlier, facing a stack of 209 or more amendments that had stalled final action on the bill, Dole had threatened a weekend session — even the pending holiday recess — unless senators got moving.

As the day wore on, amendments

prize amendments behind closed doors while the bill was being written but that other senators had to carry on their fight on the Senate floor and find a way to pay for provisions they proposed.

Stevens protested, for example, that he had been unable to win a benefit for owners of a herd of reindeer that his tribe in Alaska had not found an offsetting tax increase to pay for it.

"My state is going to be heard from on the floor of this Senate," Stevens said. "I want everyone to understand that we are going to get some answers."

For the second day in a row, the Senate defeated an attempt to deliver more of the bill's tax cuts to middle-income people. A 92-7 vote killed an amendment by Sen. Dennis DeConcini, D-Ariz., that would have given larger tax cuts to those with incomes between \$30,000 and \$10,000.

See TAX on Page A2

Cyanide-tainted painkiller linked to 2nd Seattle death

By KATIA BLACKBURN The Associated Press

SEATTLE — A man who died earlier this month was killed by cyanide after he swallowed Extra-Strength Excedrin capsules from a tainted bottle, authorities said Thursday, in the second poisoning death linked to the painkiller.

Bruce Nickell died June 5 of acute cyanide poisoning, said Dr. Corinne Fligner of the King County medical examiner's office.

"We assume that he took Extra-Strength Excedrin that had cyanide in it, but I can't say that because I wasn't there and I didn't see what he swallowed," Fligner said. "We assume the two things are related."

She said there was no test to determine for sure whether Nickell had swallowed Excedrin.

Nickell lived in Auburn, Wash., five miles away from Katherine Sue Snow, whose June 11 death was linked to cyanide in a bottle of Extra-Strength Excedrin capsules.

The cyanide from a capsule in Nickell's bottle appeared to match a sample taken from Snow's bottle, said Jim Davis, director of the investigations branch of the Food and Drug Administration in Seattle.

—The FDA — on Wednesday — night issued a warning against use of the



JIM DAVIS Samples of poison match

medication, and manufacturer Bristol-Myers followed with a nationwide recall of Extra-Strength Excedrin capsules.

Potassium cyanide also was found in a capsule from a bottle used by Nickell, 52, said Sue Hatcherott, an FDA spokeswoman in Seattle.

Nickell, a state employee, had taken capsules from the bottle, his wife said.

He initially was pronounced dead

of natural causes at Harborview Medical Center in Seattle. He suffered lung problems.

The deaths now being investigated as a cyanide-related death," the King County medical examiner's office said.

Of the 56 capsules left inside the 60-capsule bottle in Snow's home, three contained significant amounts of cyanide, FDA officials said. One cyanide-laced capsule was found in the bottle from the Nickell home, said Kelly Fry, an FDA spokeswoman.

Steve Nickell had noticed that the lot number 5-H192 on the bottle matched the number on a bottle used by Snow, said FDA spokesman Bill Grigg in Washington, D.C.

Snow and the Nickells could have shipped at the same store, said Jim Detrick of the Auburn Police Department.

Paul Webking, Snow's husband, said he thought his wife had purchased her bottle a few days earlier at an Auburn Safeway of Albertsons store.

Doctors had performed an autopsy on Nickell, but Harborview spokeswoman Tina Mankowski said toxin screens are not part of a normal autopsy routine unless there's some reason for suspicion, in which case an autopsy is referred to the medical examiner.



Times-News photo/SKYE SAEVON

Signature seeker

Manning a table in downtown Twin Falls, Susan Jensen, left, has been collecting signatures in favor of putting a lottery initiative on the ballot this fall. The petition drive, which was organized

by Sen. James E. Risch, R-Boise, will continue in Twin Falls through June 24. A total of 30,000 signatures is necessary and over 20,000 of those have already been gathered.

Nicotine's hook as sharp as opium

The Associated Press

BOSTON — Tobacco shows "stunning" parallels with opium in its power to addict its users and keep them hooked, according to a Harvard report.

Both substances create strong physical dependence, the report notes, and users of both suffer withdrawal symptoms when they try to kick the habit and often fall to give it up for good.

"In the larger scheme of things, in terms of the burden of ill health and premature diseases in this country, heroin use is dwarfed by the smoking problem. There's no comparison whatsoever," said Dr. Jay A.

Winsten of the Harvard School of Public Health.

Winsten is director of the school's Center for Health Communications, which issued the report Thursday.

The addictive substance in tobacco is nicotine, while opium is the source of heroin. Among the similarities cited between the two substances:

• Both produce strong withdrawal symptoms. Those of opium products include rapid heart beat, runny nose, sweating, fever, insomnia and diarrhea, while tobacco's include craving for tobacco, irritability, restlessness, drowsiness and intestinal upsets. Opium symptoms go away within seven to 10 days, while those

of tobacco may linger for several weeks.

• Users of both develop a tolerance and must use increasing amounts to satisfy their needs.

• Like heroin users, 70 percent of smokers who successfully give up the habit relapse in the first three months, and 75 percent do so by the end of the first year.

• Both drugs alter mood. After each puff of a cigarette, a burst of nicotine reaches the central nervous system that induces feelings of satisfaction.

• There are substitutes for both kinds of addiction — nicotine chewing gum for smokers and methadone for heroin users.

Tour airline suspends flights as canyon crash probe starts

By PAUL DAVENPORT The Associated Press

GRAND CANYON VILLAGE, Ariz. — Grand Canyon Airlines suspended tour flights Thursday as crews working in rugged terrain recovered the bodies of all 25 people killed when a helicopter and airplane collided, then crashed in flames into the canyon.

Officials said there were indications the helicopter's main rotor had sheared off the plane's tail, and that one of the plane's tires had struck the helicopter's engine cover.

"I don't know at what altitude the collision

Flight fight flares — B4

occurred, but my best guess is that it happened below the rim" of the canyon, said John Guthrie, deputy superintendent of Grand Canyon National Park.

The National Park Service and the Federal Aviation Administration have said aircraft are supposed to fly no lower than 2,000 feet

above the mile-high rim, but opponents of the advisory regulation is rarely enforced.

Flight manifests showed that 18 of the victims of Wednesday's crash were foreign tourists, authorities said.

Four Americans aboard the plane were identified Thursday, said Sheriff Joe Richards.

They were: Marcus Christian and Katrina Christian, both of Brentwood, Ala.; Sherry Goss of Jappa, Md.; and Jay Whittenburg of Mountain Home, Ark. No ages were available.

There was no indication when the names of other victims would be available. Earlier, Dr. William Thomas, Coconino County medical examiner, said it might take as long as 10 days to identify the badly charred bodies.

Grand Canyon Airlines of nearby Tusayan, which owned the 20-occupant DeHavilland Twin Otter airplane, said it was suspending air tour operations pending results of the crash investigation.

Coconino County detectives returned Thursday to the crash site at Tuna Creek, a tributary of the Colorado River, to

photograph, diagram and measure the impact points.

National Guard helicopters were used to remove the bodies, which were taken to Park Service maintenance building for storage in a refrigerated trailer pending transfer to Flagstaff, 130 miles to the south. Authorities announced a memorial service for the victims Sunday at the Grand Canyon lodge.

National Transportation Safety Board investigators from Washington arrived Thursday to begin sorting out the final seconds of the aircraft.

Baker cites importance of keeping Symms' seat for GOP

POCATELLO (AP) — Former Senate Majority Leader Howard Baker says when Republican Steve Symms was elected to the U.S. Senate six years ago, that was one of the things that helped him become a leader.

He said here Thursday night he considers Symms' re-election one of the most important races in the country. "Other than the presidency itself, nothing is more important to this country than the re-election of Steve Symms" and other Republican senators facing tough battles.

About 60 Republicans began gathering Thursday night for party meetings that are to continue through Saturday afternoon.

New state officers will be elected, but party Chairman Blake Hill is not expected to face serious opposition for another term.

Lyn Nofziger, a close associate of President Reagan, is to give the keynote speech this morning. New Hampshire Gov. John Sununu is featured speaker at Friday's dinner.

Baker told a news conference he isn't ready yet to decide whether he will make another bid for the Republican presidential nomination.

But he said as soon as the November general election is over, he will sit down and make that decision.

Baker said he plans to concentrate his efforts this year on the 21 contested Senate races. He said he's optimistic Republicans will keep their slim majority in the Senate.

"It won't be easy. We've got to hang on to this seat and the others

around the country," Baker said.

He said there are a handful of races where Republicans are in trouble. But he said Symms' campaign against Democratic Gov. John Evans is not one of them.

Baker predicted that Congress will have a new tax bill on the president's desk by Labor Day, but he declined to predict what it will contain.

Baker said he thought Sen. James McClure, R-Idaho, has at least a chance of winning the Senate leadership job if Republicans retain control of the Senate.

"He is held in extremely high regard by the other senators. But in a contested race with secret ballots, you never know. There's simply no way to tell how it would come out," Baker said.

Baker said Tennessee is a right-to-work state, and he flatly supports right to work.

He was asked that in his state, whether economic development came

first, or whether Tennessee's improved educational facilities helped land new industry. He said those decisions must be made by each state. "You just take the bull by the horns and do it," he said referring to his state's major commitment to improving education.

Symms said he wasn't ready to commit himself to any presidential contender yet.

"You are one of my candidates for president," he told Baker.

Briefly

French hostages to go free

BEIRUT, Lebanon (AP) — An anonymous telephone caller on Friday said two French television crewmembers kidnapped here in March would be released in 24 hours, the Independent Beirut newspaper al-Nahar reported.

It was not possible to confirm the caller's statement.

al-Nahar said an Arabic-speaking caller claimed he spoke for the Revolutionary Justice Organization that took responsibility for the abduction of four crew members of France's Antenne-2 station in Moslem West Beirut.

Gramm-Rudman will be fixed

WASHINGTON (AP) — The three main authors of the nation's budget-balancing law said Thursday they will team up again in an effort to fix the law if the Supreme Court strikes down its central enforcement mechanism as expected.

Sens. Phil Gramm, R-Texas, Warren Rudman, R-N.H., and Ernest F. Hollings, D-S.C., said that instead of relying on a backup provision in the law calling for a vote of Congress to carry out across-the-board spending cuts, they would rather try to amend the law to overcome the court's anticipated constitutional objections.

"We have a perfect vehicle to do that in that the current debt ceiling is going to expire on Aug. 1," Gramm told reporters. He noted that was just two weeks before the date when spending cuts would be ordered under the law.

House legislation condemned

WASHINGTON (AP) — The far-reaching House legislation that would require all U.S. firms to withdraw from South Africa drew angry condemnation Thursday from the Reagan administration as a misguided approach to dealing with racial separation and repression in the troubled country.

"We still believe that our business presence there gives us some limited influence over the course of events," the State Department declared. "We do not believe we should abandon the forces of moderation and compromise in that country."

Today's weather

Fair, mild as spring becomes summer

Twin Falls, Burley, Rupert, Jerome and Gooding:

Fair today. Highs in the upper 70s to near 80. Tonight and Saturday, fair and cool. Lows in the 40s. Highs said to upper 70s.

Caracas Prairie, Halley and the Lower Wood River Valley:

Today, sunny. Highs in the 70s. Tonight and Saturday, fair and cool. Lows in the 30s. Highs in the 70s.

Northern Utah and Nevada:

Utah: Mostly sunny days and fair nights statewide through Saturday. A blizzard likely north Saturday. Lows tonight 50s to mid-60s. Highs 85 to 95.

Nevada: Mostly sunny this morning. Fair with sunny skies Saturday. Highs today mid-70s to upper 80s. Lows tonight low 30s to low 50s. Highs Saturday upper 70s to low 90s.

Synopsis:

The National Weather Service says cool temperatures continued over the state Thursday in the wake of the frontal system that passed over the region on Wednesday.

An upper-level low pressure system is continuing to dominate the weather picture aloft, but on the surface high pressure is building from the west. Most clear skies blanketed the state earlier except in the extreme north where a few clouds persisted.

The high temperature in Idaho Thursday was 81 degrees at Malat.

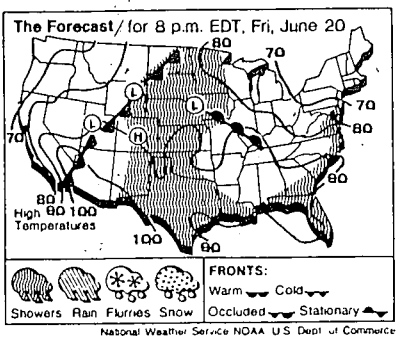

while Stanley registered the low of 27 day and Tuesday. Highs 75 to 85 Sunday and 80s to 90s Monday and Tuesday. Lows 40s Sunday and 50s by Tuesday.

Elsewhere around the nation, Thursday's high temperature was 141 degrees at Bullhead City, Ariz., and the low was 29 degrees at Redmond, Ore.

National

| | | | |
|----------------|-----|----|----|
| Albuquerque | 89 | 64 | 79 |
| Albany | 89 | 68 | 79 |
| Chicago | 79 | 57 | 71 |
| Dallas | 90 | 67 | 77 |
| Denver | 87 | 59 | 71 |
| Detroit | 82 | 66 | 71 |
| Honolulu | 81 | 75 | 81 |
| Indianapolis | 86 | 52 | 72 |
| Kansas City | 92 | 71 | 81 |
| Las Vegas | 102 | 83 | 93 |
| Los Angeles | 84 | 63 | 73 |
| Memphis | 91 | 66 | 76 |
| Minneapolis | 84 | 63 | 73 |
| Milwaukee | 90 | 65 | 74 |
| New Orleans | 93 | 74 | 83 |
| New York | 93 | 73 | 82 |
| Omaha | 91 | 71 | 81 |
| Orlando | 93 | 71 | 81 |
| Philadelphia | 90 | 70 | 80 |
| Pittsburgh | 72 | 44 | 54 |
| Portland Me. | 77 | 44 | 54 |
| Portland Ore. | 77 | 44 | 54 |
| Portland Wash. | 77 | 44 | 54 |
| San Antonio | 91 | 64 | 74 |
| San Diego | 91 | 64 | 74 |
| San Francisco | 77 | 54 | 64 |
| Seattle | 77 | 54 | 64 |
| St. Louis | 91 | 64 | 74 |
| St. Paul | 91 | 64 | 74 |
| Tampa | 91 | 64 | 74 |
| Washington | 91 | 64 | 74 |
| Wichita | 91 | 64 | 74 |

Idaho

| | | | |
|--------------|----|----|----|
| Boise | 81 | 50 | 71 |
| Blaine | 77 | 44 | 54 |
| Blackfoot | 77 | 44 | 54 |
| Burley | 77 | 44 | 54 |
| Camden | 77 | 44 | 54 |
| Chubbuck | 77 | 44 | 54 |
| Donnerstag | 77 | 44 | 54 |
| Elgin | 77 | 44 | 54 |
| Emmett | 77 | 44 | 54 |
| Franklin | 77 | 44 | 54 |
| Glenn | 77 | 44 | 54 |
| Hamlet | 77 | 44 | 54 |
| Harlow | 77 | 44 | 54 |
| Heppner | 77 | 44 | 54 |
| Home | 77 | 44 | 54 |
| Jerome | 77 | 44 | 54 |
| Ketchikan | 77 | 44 | 54 |
| Latah | 77 | 44 | 54 |
| Malat | 81 | 50 | 71 |
| Marion | 77 | 44 | 54 |
| McCall | 77 | 44 | 54 |
| Miner | 77 | 44 | 54 |
| Morehead | 77 | 44 | 54 |
| Mullan | 77 | 44 | 54 |
| Northwood | 77 | 44 | 54 |
| Parma | 77 | 44 | 54 |
| Payson | 77 | 44 | 54 |
| Prater | 77 | 44 | 54 |
| Rupert | 77 | 44 | 54 |
| Shoshone | 77 | 44 | 54 |
| St. Charles | 77 | 44 | 54 |
| St. Leon | 77 | 44 | 54 |
| St. Paul | 77 | 44 | 54 |
| St. Regis | 77 | 44 | 54 |
| Timberline | 77 | 44 | 54 |
| Townsend | 77 | 44 | 54 |
| Trinidad | 77 | 44 | 54 |
| Victory | 77 | 44 | 54 |
| Walden | 77 | 44 | 54 |
| Wendover | 77 | 44 | 54 |
| White Salmon | 77 | 44 | 54 |
| Yamhill | 77 | 44 | 54 |

Circulation

Circulation phones are manned between 7 and 10 a.m. only. If you do not receive your paper by 7 a.m., call the number by your area:

Jerome-Wendell-Gooding-Hagerman 536-2535
Burley-Rupert-Paul-Oakley 678-2552
Buhl-Castlerford 543-4648
Filer-Rogers-Hall-Okley 326-5375
Twin Falls and all other areas 733-0931

News Stephen Hartgen, managing editor

If you have a news tip or wish to talk to someone in the editorial department, call 733-0931 between 9:30 a.m. and 5:30 p.m. weekdays. To report late news and sports results after 5:30 and on weekends, call 733-0936.

Advertising Bill Blahs, advertising director

If you wish to place an advertisement, call 733-0931. Classified ads are taken Monday through Friday from 8 a.m. until 5 p.m. and Saturdays from 8 a.m. until noon. Information on display ads is available weekdays only.

Subscription Rates

City-home delivery: daily, \$1.50 per week; Sunday, The per week; daily and Sunday, \$1.80 per week. Rural motor-route delivery: daily, \$1.50 per week; Sunday, The per week; daily and Sunday, \$1.90 per week. Mail subscriptions must be paid in advance and are available only where carrier delivery is not maintained: daily and Sunday, 3 months \$21.80, 6 months \$41.40, 12 months \$78.00; daily only, 1 month \$6.65, 3 months \$18.50, 6 months \$33.90, 12 months \$67.80; Sunday only, 1 month \$4.45, 3 months \$13.35, 6 months \$25.70, 12 months \$50.40. Student and servicemembers rates, by mail only, \$2.00 per month for daily and Sunday.

Mail Information

The Times-News is published daily at 121 Third St. W., Twin Falls, Idaho, 83401, by Magic Valley Newspapers Inc. Second-class postage paid at Twin Falls by The Times-News (USPS 031-000). Official city and county newspaper pursuant to Statute of Idaho, Title 24, Section 24-202. Thursday is hereby designated as the day of the week on which legal notices will be published.

American soldier shot, killed

TEGUCIGALPA, Honduras (AP) — A Honduran soldier shot and killed an American soldier during joint military maneuvers in this Central American country, U.S. military sources said Thursday.

The U.S. sources said military authorities from both countries were investigating whether the killing was accidental.

The name of the soldier was being withheld pending notification of next of kin, said the sources, who spoke on condition of anonymity.

The shooting occurred near Juticalpa, capital of Tegucigalpa, about 125 miles east of Tegucigalpa, the U.S. sources said.

Suit aims to break mob hold

NEW YORK (AP) — Prosecutors opened a new assault against organized crime Thursday with a civil lawsuit aimed at breaking the Mafia's alleged hold on New York City's cement industry.

The lawsuit, filed under federal racketeering laws, asks U.S. District Judge Vincent Broderick to appoint trustees to manage the affairs of the District Council of Cement and Concrete Workers and one of its member organizations, Local 6A, Cement and Concrete Workers of the Laborers International Union of North America.

The union has been "infiltrated, dominated and exploited" by the Colombo organized crime family, the lawsuit charges.

Guerrillas attack garrison

SAN SALVADOR, El Salvador (AP) — The military said leftist guerrillas on Thursday killed or wounded 50 government troops in a rifle and mortar attack on a San Miguel garrison that also houses American advisers.

The U.S. Embassy said three American military advisers and two U.S. military physicians were inside the walled garrison at the time of the four-hour, pre-dawn attack, but escaped injury.

The guerrillas, grouped as the Farabundo Marti National Liberation Front, claimed during a broadcast of their clandestine Radio Venceremos that the attack by four battalions resulted in 253 soldiers killed or wounded.

Reagan

Continued from Page A1

essential goodness of our nation." He said the community reminded him of Dixon, Ill., where he grew up.

Many people in the crowd waved little American flags and some carried placards with such messages as "Mr. Reagan, God bless you."

Of the suggested meeting between his and Gorbachev's aides, Reagan

Tax

Continued from Page A1

and shifted the burden to U.S. businesses operating abroad.

But on a 94-4 vote, with Sen. Barry Goldwater, R-Ariz., in opposition, the Senate adopted a non-binding resolution saying negotiators should place a high priority on helping the middle class when the final bill is written.

Meanwhile, Rep. Dan Rostenkowski, D-Ill., chairman of the House Ways and Means Committee, said Democratic tax-writers in the House are "concerned with how the middle-income family will be treated" in the final tax bill.

The plan passed by the House would give more relief to those taxpayers that measure to the Senate bill.

A conference, which Rostenkowski is expected to head, will compromise the differences.

Aid by voice vote was an amendment by Sen. James McClure, R-Idaho, allowing Individual Retirement Account investments in gold and silver coins.

The amendment allowing a deduction for some state and local sales taxes was accepted by voice vote with the concurrence of the bill's manager, Sen. Bob Packwood, R-Ore.

told the graduates, "The location is unimportant. What matters is that such a meeting take place in mutual earnestness so that we can make progress at the next summit."

"The time has come to move forward," Reagan said at one point. "The goal here is not complicated. I am suggesting that we agree not to how many new bigger, and more accurate missiles can be built, but on how to reduce and ultimately eliminate all nuclear missiles."

Vice President George Bush, when asked by reporters about the latest Soviet offer, said: "When they say something, we ought not to always find something bad in it. I think this time there are some very positive things in it."

Tax SALT

Continued from Page A1

passage of a proposal by Sen. Gary Hart, D-Colo., which also requires continued compliance with SALT II.

The vote came in a closed session of the panel as it wrote its version of a Pentagon spending bill. Hart's proposal, which he announced later, was adopted as an amendment to the bill.

Reagan's May 27 announcement that he would not be bound in the future by the limits in the unratified SALT II has fanned off widespread debate on Capitol Hill, along with several legislative proposals.

The House resolution was the first measure to reach the floor of either chamber, but a similar resolution has been introduced in the Republican-controlled Senate.

Also pending in both chambers are bills that would ban the spending of any money to build nuclear weapons that would exceed the limits in the 1979 treaty.

The resolution approved Thursday

SALT

was chiefly sponsored by Rep. Dante Fascell, D-Fla., chairman of the Foreign Affairs Committee, which voted 29-11 passage last week.

Rep. William Broomfield of Michigan, ranking Republican on the panel, offered the Republican alternative that was voted down shortly before the resolution passed. Broomfield's proposal would have Reagan adhere to the SALT II limits as long as the Soviets do likewise. Since Reagan says the Soviets don't adhere to the pact, that would mean Reagan's new policy could go ahead.

The House resolution was the first measure to reach the floor of either chamber, but a similar resolution has been introduced in the Republican-controlled Senate.

Also pending in both chambers are bills that would ban the spending of any money to build nuclear weapons that would exceed the limits in the 1979 treaty.

The resolution approved Thursday

was chiefly sponsored by Rep. Dante Fascell, D-Fla., chairman of the Foreign Affairs Committee, which voted 29-11 passage last week.

Rep. William Broomfield of Michigan, ranking Republican on the panel, offered the Republican alternative that was voted down shortly before the resolution passed. Broomfield's proposal would have Reagan adhere to the SALT II limits as long as the Soviets do likewise. Since Reagan says the Soviets don't adhere to the pact, that would mean Reagan's new policy could go ahead.



New Arrival

ESPRIT

FOR SUMMER FUN

The fashion she loves in sizes just for girls! Sleeveless cotton knit shirt with floral print, 16.00. Coordinating floral pants, 28.00. Sizes 7-14.

124 Main Avenue North, Twin Falls • 733-1506
Open Mon.-Sat. • 10:00 A.M. to 6:00 P.M.

The Children's Attic

Boyle choice to take bench

IDAHO FALLS (AP) — Idaho Falls attorney Larry M. Boyle was appointed Thursday to fill a vacancy created by the April 1 retirement of 7th District Judge Boyd R. Thomas.

The appointment by Gov. John Evans takes effect Nov. 1, said Jean Terra, spokeswoman for the governor's office.

Boyle, 42, was elected without opposition in the May primary to a four-year term that begins Jan. 5.

He was the only applicant seeking serve the remainder of Thomas' term, which caused a delay in the appointment because state law requires the governor to have two or four names from which to choose.

FOR SALE OR LEASE!

Lovely home and/or commercial property at 335 Blue Lokos Blvd. N. Will consider remodeling to suit far qualified tenant. Call Tom Kolouch at 734-0400.

GEM STATE REALTY

1445 ADDISON AVE. EAST 734-6400

Stallings: Legal process worked at last

IDAHO FALLS (AP) — The Democrat who defeated former Idaho Rep. George Hansen in his bid for an eighth term in Congress said the legal process has finally caught up with the Republican convicted of violating the Ethics in Government Act.

"I hate to see a person be put in jail; it's a tragic thing for anybody," Rep. Richard Stallings said Thursday. "But there comes a point when you have to pay for your discretions or indiscretions."

U.S. District Judge Joyce Hens Green on Wednesday reversed a decision she made two days earlier and ordered Hansen to report to a minimum-security prison farm in

Virginia by 3 p.m. Friday.

Hansen was convicted in 1984 and sentenced to five to 15 months in prison and a \$40,000 fine for withholding personal financial information from Congress. Federal prosecutors charged Hansen omitted \$334,000 in profits, loans and other transactions from financial disclosure forms filed with the House of Representatives under the 1978 Ethics in Government Act.

Mrs. Green agreed with a Justice Department argument Wednesday that a recent decision from the U.S. Court of Appeals precluded Hansen remaining free on bond while his case is on appeal because it was doubtful he would succeed in an-

pollate court. Stallings, who defeated Hansen for re-election in 1984 by just 170 votes out of more than 200,000 cast in Idaho's 2nd District, said he has seen "absolutely no movement" on efforts Hansen has claimed were under way to clarify congressional intent for the law.

Hansen, 55, said Congress never intended for the law to carry criminal punishment, but Stallings said he agrees with the jail sentence Hansen received.

"What good is a law without some kind of punishment?" he said. Meanwhile, a former field representative for Hansen said he was shocked by Mrs. Green's decision to

order the former congressman to prison. Hansen is the only public official ever convicted under the Ethics in Government Act.

"It's incomprehensible that our system of justice would require somebody to go to prison over trumped-up charges," said John Scoreby of Idaho Falls. "This has been a set-up job from the first. . . . What's ridiculous is that if he never filed a report at all, the only thing which could have done is fine him \$5,000."

Scoreby also blamed the news media for not accurately informing the public about the issues surrounding the case.

"The media has been out to get George," he said. "They have been totally unfair in the last two years, and it has done a great disservice to Idaho and particularly to George and his family."

PREPARE FOR JULY RODEO'S

Levi's

14⁹⁷

501's 701's

EXTRA SIZES \$2.00 More



AT THE MERC BLUE LAKES MALL

PRICES GOOD FRIDAY, SATURDAY & SUNDAY

LEVI UNLINED JACKETS \$34.99

Levi's® Straight Leg Denim A New Look From an Old Friend Levi's® straight leg denim jeans. Cut long and lean — just the way you like 'em. And with heavyweight denim and Levi's® quality construction, you can be sure these jeans will be with you for a long, long time. But of course, that's just what you'd expect from a friend like Levi's.

Falling tree kills Lannen, senator who pushed lottery

PINEHURST (AP) — State Sen. Vern T. Lannen, D-Pinehurst, was killed Thursday when he was hit by a falling tree on a logging project in the Powell Ranger District in Idaho County.

Officials said Lannen, 42, was crushed by the tree about 9 a.m. Others working on the project could not free him in time to save him.

He was transported by helicopter to a hospital in Missoula, Mont., where he was pronounced dead. The accident occurred near Lowell, which is located near the Idaho-Montana state line. Idaho County sheriff's officials said an officer was investigating at the accident scene Thursday night.

Idaho County officials said they were not notified of the accident until 11:30 a.m. Lannen was employed by North Idaho Timbers. He served his fourth term in the Senate this year from the state's legislative 4th District. Lannen sponsored a number of proposals in recent

legislative sessions to amend the Idaho constitution to allow establishment of a lottery. He also sponsored legislation this past session that would have authorized the sale of liquor on Sundays in Idaho. That measure did not pass, but counties now have a local option to sell liquor on Sundays.

Lannen, who worked as a lumberjack and miner, had been mentioned in the past as a possible challenger to U.S. Rep. Larry Craig, R-Idaho. Lannen declined to run against Craig in 1984, saying Craig's campaign was too strong with President Ronald Reagan's support.

He served as a two-term Shoshone County commissioner, and also served 12 years as a member of the Panhandle Health District. He served as chairman of the Panhandle Area Council in 1976-77, and was Northern Idaho's legislative chairman for the Association of Counties from 1974 to 1978.

Lannen is survived by his wife, Judie, and two children.

Judge drops lobbyist's DUI charge

BOISE (AP) — A judge has dismissed a drunken-driving charge against William Roden, an attorney and prominent lobbyist in Idaho representing clients concerned with drinking laws.

Ada County Magistrate Patricia Flanagan dismissed the case Wednesday because the city could not prosecute Roden without evidence that the judge earlier had ruled inadmissible, according to Mona Dobaran, Boise city assistant attorney.

Roden was to have been tried Wednesday. Dobaran said the city planned to appeal the dismissal.

Flanagan had ruled Friday that field sobriety tests, breath tests and all other evidence obtained after Roden was stopped could not be admitted in the case. Although Boise Police Officer Dave Ginal was acting in good faith, his stopping of Roden was an unreasonable intrusion violating the 4th Amendment protection against unreasonable searches and seizures, she said in the evidence ruling.

Roden, 57, Boise, had not committed any traffic violations and was weaving only minimally in his lane, Flanagan said. According to the judge's recall of the testimony, Roden's car strayed outside its lane once for one-fifth of a second.

Ginal said on his police report that he stopped Roden's car after he saw it drift three times about 6 inches over the lane line for distances of about 10 feet. After the officer stopped Roden, he made him perform field sobriety tests, arrested him and gave him two breath tests. Roden's blood-alcohol content readings were 0.16 percent and 0.17 percent.

Radiation exposure survey kept on ground

POCATELLO (AP) — A federal survey crew was temporarily grounded Thursday, but expected to begin an aerial study of radionuclide exposure in Pocatello and Soda Springs within the next couple of days.

The aerial tests will begin a two-year study to test the effects of using phosphate slag in area road construction.

Environmental Protection Agency and other officials involved in the survey said Thursday that the helicopter crews will use to monitor ground radiation over the next month will be closely monitored

itself while in flight. The helicopter will canvass between 70 and 80 square miles in the Pocatello area and 15 square miles in Soda Springs, flying at a steady altitude of 150 feet and covering ground along parallel lines 250 feet apart.

While in flight, the helicopter's course will be charted by a pair of radio receivers, said Holly Berry, a project scientist for EG&G Idaho Inc.'s Energy Measurement division in Las Vegas, Nev. The twin-engine craft was grounded temporarily while crews worked on some problems with one engine.

The project will be on hold until the backup engine is operating, officials said.

"The maximum delay will be just a day or two," said John Hall of the EPA's Las Vegas office.

Once the testing begins, crews will be at work up to a month. Weather permitting, data will be gathered six days a week.

Information will be picked up by two detector pods at the bottom of the helicopter, and will be transmitted to an onboard computer. The finished product, a contour map of radiation in the region, should be completed by fall.

Malfunctioning swamp cooler may have started store fire

IDAHO FALLS (AP) — Firefighters say they suspect a malfunctioning swamp cooler on the roof of Martin Stationers may have caused a fire that destroyed the business Tuesday night. Fire Chief Doug Call said damage

to the building, the stationery store and adjacent businesses could exceed \$1 million.

Call said there had been reports of a hot smell around the building earlier in the day. Firefighters said they believe the fire started in the

ceiling of the stationery store at 560 First St.

Jeff Martin, co-owner of the store, estimated the value of lost inventory and furnishings may run between \$600,000 and \$750,000.

SUNSATONAL Savings of The **MERC**

IN THE BLUE LAKES SHOPPING CENTER
PENBROOKE JUNIOR MISSSES SWIMSUITS

SAVE

30%

BIG SAVINGS SPLASH

SIZES 7 TO 13 32 TO 38

REG. 17.95 TO 21.95 NOW \$12.56 TO \$15.36

"DAN POST" Boot Sale!

PEGGED STEEL ARCH-LEATHER LINED ALL LEATHER UPPERS CONSTRUCTED FOR LOOKS AND WEAR

YOUR CHOICE \$88

TOP GRAIN COW HIDE Regular \$125.00

BULL HIDE Regular \$135.00

ACME-SALE!

LEATHER FOOT CONSTRUCTION Widths B-D-EE Reg. \$59.99

YOUR CHOICE \$44.00

Baker cites importance of keeping Symms' seat for GOP

POCATELLO (AP) — Former Senate Majority Leader Howard Baker says when Republican Steve Symms was elected to the U.S. Senate six years ago, that was one of the things that helped him become majority leader.

He said here Thursday night he considers Symms' re-election one of the most important races in the country. "Other than the presidency itself, nothing is more important to this country than the re-election of Steve Symms," he said.

Baker told a news conference he isn't ready yet to decide whether he will make another bid for the Republican presidential nomination. But he said as soon as the November general election is over, he will sit down and make that decision.

Baker said he plans to concentrate his efforts this year on the 21 contested Senate races. He said he's optimistic Republicans will keep their slim majority in the Senate.

"It won't be easy. We've got to hang on to this seat and the others

around the country," Baker said.

He said there are a handful of races where Republicans are in trouble. But he said Symms' campaign against Democratic Gov. John Evans is not one of them.

Baker predicted that Congress will have a new tax bill on the president's desk by Labor Day, but he declined to predict what it will contain.

Baker said he thought Sen. James McClure, R-Idaho, has at least a chance of winning the Senate leader-

ship job if Republicans retain control of the Senate.

"He is held in extremely high regard by the other senators. But in a contested race with secret ballots, you never know. There's simply no way to tell how it would come out," Baker said.

Baker said Tennessee is a right-to-work state, and he flatly supports right to work.

He was asked that in his state, whether economic development came

first, or whether Tennessee's improved educational facilities helped lead new industry. He said those decisions must be made by each state. "You just take the bill by the horns and do it," he said referring to his state's major commitment to improving education.

Symms said he wasn't ready to commit himself to any presidential contender yet.

"You are one of my candidates for president," he told Baker.

how to reduce or ultimately eliminate all nuclear missiles."

Vice President George Bush, when asked by reporters about the latest Soviet offer, said: "When they say something, we ought not to always find something bad in it. I think this time there are some very positive things in it."

Briefly

French hostages to go free

BEIRUT, Lebanon (AP) — An anonymous telephone call on Friday said two French television crewmembers kidnapped here in March would be released in 24 hours, the independent Beirut newspaper al-Nahar reported.

It was not possible to confirm the caller's statement.

An-Nahar said an Arabic-speaking caller claimed he spoke for the Revolutionary Justice Organization that took responsibility for the abduction of four crew members of France's Antenne-2 station in Moleim West Beirut.

Gramm-Rudman will be fixed

WASHINGTON (AP) — The three main authors of the nation's budget-balancing law said Thursday they will team up in an effort to fix the law if the Supreme Court strikes down its central enforcement mechanism as expected.

Sens. Phil Gramm, R-Texas, Warren Rudman, R-N.H., and Ernest F. Hollings, D-S.C., said that instead of relying on a backup provision in the law calling for a vote of Congress to carry out across-the-board spending cuts, they would rather try to amend the law to overcome the court's anticipated constitutional objections.

"We have a perfect vehicle to do that in that the (current) debt ceiling is going to expire on Aug. 1," Gramm told reporters. He noted that was just two weeks before the date when spending cuts are to be ordered under the law.

House legislation condemned

WASHINGTON (AP) — The far-reaching House legislation that would require all U.S. firms to withdraw from South Africa drew stinging condemnation Thursday from the Reagan administration as a misguided approach to dealing with racial separation and repression in the troubled country.

"We still believe that our business presence there gives us some limited influence over the course of events," the State Department declared. "We do not believe we should abandon the forces of moderation and compromise in that country."

American soldier shot, killed

TEGUIGUALPA, Honduras (AP) — A Honduran soldier shot and killed an American soldier during joint military maneuvers in this Central American country, U.S. military sources said Thursday.

The U.S. sources said military authorities from both countries were investigating whether the killing was accidental.

The name of the soldier was being withheld pending notification of next of kin, said the sources, who spoke on condition of anonymity.

The shooting occurred near Juticalpa, capital of Tegucigalpa, about 125 miles east of Tegucigalpa, the U.S. sources said.

Suit aims to break mob hold

NEW YORK (AP) — Prosecutors opened a new assault against organized crime Thursday with a civil lawsuit aimed at breaking the Mafia's alleged hold on New York City's cement industry.

The lawsuit, filed under federal racketeering laws, asks U.S. District Judge Vincent Broderick to appoint trustees to manage the affairs of the District Council of Cement and Concrete Workers and one of its member organizations, Local 64, Cement and Concrete Workers of the Laborers International Union of North America.

The union has been "infiltrated, dominated and exploited" by the Colombo organized crime family.

Guerrillas attack garrison

SAN SALVADOR, El Salvador (AP) — The military said leftist guerrillas on Thursday killed or wounded 31 government troops in a rifle and mortar attack on a San Miguel garrison that also houses American advisers.

The U.S. Embassy said three American military advisers and two U.S. military physicians were inside the walled garrison at the time of the four-hour, pre-dawn attack, but escaped injury.

The guerrillas, grouped as the Farabundo Martí National Liberation Front, claimed during a broadcast by their clandestine Radio Venceremos that the attack by four battalions resulted in 253 soldiers killed or wounded.

Reagan

Continued from Page A1

essential goodness of our nation." He said the community reminded him of Dixon, Ill., where he grew up.

Many people in the crowd waved little American flags and some carried placards with such messages as "Mr. Reagan, God bless you."

Of the suggested meeting, between his and Gorbachev's aides, Reagan

told the graduates. "The location is unimportant. What matters is that such a meeting take place in mutual earnestness so that we can make progress at the next summit."

"The time has come to move forward," Reagan said at one point. "The goal here is not complicated. I am suggesting that we agree not on how many new bigger, and more ac-

curate missiles can be built, but on how to reduce or ultimately eliminate all nuclear missiles."

Vice President George Bush, when asked by reporters about the latest Soviet offer, said: "When they say something, we ought not to always find something bad in it. I think this time there are some very positive things in it."

Tax

Continued from Page A1

and shifted the burden to U.S. businesses operating abroad.

But on a 94-1 vote, with Sen. Barry Goldwater, R-Ariz., in opposition, the Senate adopted a non-binding resolution saying negotiators should place a high priority on helping the middle class when the final bill is written.

Meantime, Rep. Dan Rostenkowski, D-Ill., chairman of the House Ways and Means Committee, said Democratic tax-writers in the House are "concerned with how the middle-income family will be treated in the final tax bill. The plan passed by the House would give more relief to those taxpayers than would the Senate bill.

SALT

Continued from Page A1

passage of a proposal by Sen. Gary Hart, D-Colo., which also urges continued compliance with SALT II.

The vote came in a closed session of the panel as it wrote its version of a Pentagon spending bill. Hart's proposal, which he announced later, was adopted as an amendment to the bill.

Reagan's May 27 announcement that he would not be bound in the future by the limits in the unratified SALT II has touched off widespread debate on Capitol Hill, along with several legislative proposals.

was chiefly sponsored by Rep. Dante Fascell, D-Fla., chairman of the Foreign Affairs Committee, which voted 29-11 passage last week.

Rep. William Brockmeyer of Michigan, ranking Republican on the panel, offered the Republican alternative that was voted down shortly before the resolution passed. Brockmeyer's proposal would have Reagan adhere to the SALT limits as long as the Soviets do likewise. Since Reagan says the Soviets don't adhere to the pact, that would mean Reagan's new policy could go ahead.

Engberg's
STOREWIDE MOVING CLEARANCE - SAVE NOW!
2000 EAST 14th STREET, BURLEY, IDAHO 83318 • 288-478-2434

A conference, which Rostenkowski is expected to head, will compromise the differences.

Adopted by voice vote was an amendment by Sen. James McClure, R-Idaho, allowing Individual Retirement Account investments in gold and silver coins.

The amendment allowing a deduction for some state and local sales taxes was accepted by voice vote with the concurrence of the bill's manager, Sen. Bob Packwood, R-Ore.

The House resolution was the first measure to reach the floor of either chamber, but a similar resolution has been introduced in the Republican-controlled Senate.

Also pending in both chambers are bills that would ban the spending of any money to build nuclear weapons that would exceed the limits in the 1974 treaty.

The resolution approved Thursday

The bill would continue deductions for state and local income and property taxes but would repeal the writedoff for sales taxes. The tax overhaul plan passed by the House would continue full deduction of all state and local taxes.

Under the amendment, sponsored by Sens. Slade Gorton and Dan Evans, both R-Wash., a person whose state and local sales taxes were higher than state and local income taxes could deduct 60 percent of the excess. For example, a family that paid \$1,200 in sales taxes and \$800 in income taxes could deduct all the income tax plus \$240 — 60 percent of \$400.

A person who paid \$1,000 in sales tax and no income tax could deduct \$500.

The amendment would benefit any taxpayer in any state who pays more sales tax than state and local income tax. It would have the largest impact in 14 states — Alaska, Connecticut, Florida, Louisiana, Mississippi, Nevada, New Hampshire, New Mexico, North Dakota, South Dakota, Tennessee, Texas, Washington and Wyoming — where sales taxes are a bigger source or revenue than income taxes.

The amendment would benefit any taxpayer in any state who pays more sales tax than state and local income tax. It would have the largest impact in 14 states — Alaska, Connecticut, Florida, Louisiana, Mississippi, Nevada, New Hampshire, New Mexico, North Dakota, South Dakota, Tennessee, Texas, Washington and Wyoming — where sales taxes are a bigger source or revenue than income taxes.

Today's weather

Fair, mild as spring becomes summer

Twin Falls, Burley, Rupert, Jerome and Gooding:
Fair today. Highs in the upper 70s to near 80. Tonight and Saturday, fair and cool. Lows in the 40s. Highs said to upper 70s.
Comas Prairie, Halley and the Lower Wood River Valley:
Today, sunny. Highs in the 70s. Tonight and Saturday, fair and cool. Lows mostly in the 30s. Highs in the 70s.
Northern Utah and Nevada:
Utah: Mostly sunny days and fair nights Saturday through Saturday. A little cooler north Saturday. Lows tonight 50s to mid-60s. Highs 60s to 70s.
Nevada: Mostly sunny this morning. Fair with sunny skies Saturday. Highs today mid-70s to upper 80s, lows tonight low 30s to low 50s. Highs Saturday upper 70s to low 80s.

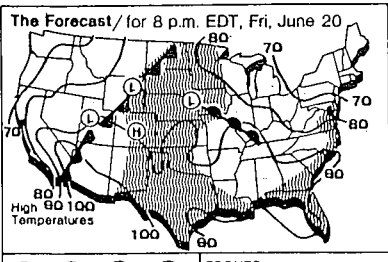

The National Weather Service says cool temperatures continued over the state Thursday in the wake of the front system that passed over the region on Wednesday.

An upper level low pressure system is continuing to dominate the weather pattern, but on the surface high pressure is building from the west. Mostly clear skies blanket the state earlier except in the extreme north where low clouds persist.

The high temperature in Idaho Thursday was 81 degrees at Malad, while Stanley registered the low of 27 degrees.

The pollen count in Twin Falls Thursday was 87 particles per cubic meter of air.

The extended forecast for Southern Idaho, warming trend. Fair except for a few mountain thundershowers. Many days and Tuesday. Highs 75 to 85 Sunday and 70s to 80s Monday and Tuesday. Lows 40s Sunday and 50s by Tuesday.

Elsewhere around the nation, Thursday's high temperature was 111 degrees at Billard City, Ariz., and the low was 30 degrees at Richmond, Ore.

| National | | Idaho | |
|-----------------|-----|------------------|-----|
| Max | Min | Max | Min |
| Albuquerque 89 | 61 | Portland 81 | 71 |
| Atlanta 89 | 60 | San Francisco 72 | 54 |
| Boston 79 | 60 | Seattle 71 | 50 |
| Chicago 82 | 66 | Spokane 72 | 52 |
| Dallas 90 | 71 | Tampa 81 | 61 |
| Denver 87 | 53 | Washington 72 | 62 |
| Des Moines 82 | 71 | Boise 73 | 54 |
| Detroit 82 | 67 | Butte 71 | 53 |
| Honolulu 87 | 75 | Hailey 71 | 51 |
| Houston 86 | 72 | Idaho Falls 71 | 51 |
| Indianapolis 86 | 59 | Shoshone 71 | 51 |

Index

| | | | | | |
|----------------|------|--------------|----|-------------|------|
| Business | B7-8 | Idaho | A3 | People | A7 |
| Classified | C1-8 | Magic Valley | B1 | Sports | B5-6 |
| Comics | A6 | Nation | A5 | Valley life | B3 |
| Dear Abby | B3 | Obituaries | B2 | West | B4 |
| Friday Special | D1-8 | Opinion | A4 | World | A6 |

Circulation
Circulation phones are manned between 7 and 10 a.m. only. If you do not receive your paper by 7 a.m., call the number for your area:

Jerome-Wendell-Gooding-Hagerman 536-2535
Burley-Ruppel-Paul-Okley 678-2532
Buhl-Castledorf 543-4648
Filer-Rogerson-Hollister 326-5375
Twin Falls and all other areas 733-0931

News Stephen Hartgen, managing editor
If you have a news tip or wish to talk to someone in the editorial department, call 733-0931 between 9:30 a.m. and 5:30 p.m. weekdays. To report late news and sports results after 5:30 and on weekends, call 733-0936.

Advertising Dan Blake, advertising director
If you wish to place an advertisement, call 733-0931. Classified ads are taken Monday through Friday from 8 a.m. until 5 p.m. and Saturdays from 8 a.m. until noon. Information on display ads is available weekdays only.

Boyle choice to take bench

IDAHO FALLS (AP) — Idaho Falls attorney Larry M. Boyle was appointed Thursday to fill a vacancy created by the April 1 retirement of 7th District Judge Boyd R. Thomas.

The appointment by Gov. John Evans takes effect Nov. 1, said Jean Terra, spokeswoman for the governor's office.

Boyle, 42, was elected without opposition in the May primary to a four-year term that begins Jan. 5.

He was the only applicant seeking to fill the remainder of Thomas' term, which caused a delay in the appointment because state law requires the governor to have two to four names from which to choose.



ESPRIT
FOR SUMMER FUN

The fashion she loves in sizes just for girls! Sleeveless cotton knit shirt with floral print, 16.00. Coordinating floral pants, 28.00. Sizes 7-14.

The Paris
The Children's Attic
124 Main Avenue North, Twin Falls • 733-1506
Open Mon.-Sat. • 10:00 A.M. to 6:00 P.M.

FOR SALE OR LEASE!

Lovely home and/or commercial property at 335 Blue Lokos Blvd. N. Will consider remodeling to suit qualified tenant. Call Tom Kolouch at 734-0400.

GEM STATE REALTY
1445 ADDISON AVE. EAST 734-0400

Stallings: Legal process worked at last

IDAHO FALLS (AP) — The Democrat who defeated former Idaho Rep. George Hansen in his bid for an eighth term in Congress said the legal process has finally caught up with the Republican convicted of violating the Ethics in Government Act.

"I hate to see a person be put in jail. It's a tragic thing for me," Rep. Richard Stallings, D-Idaho, said Thursday. "But there comes a point when you have to pay for your decisions or indiscretions."

U.S. District Judge Joyce Hens Green on Wednesday reversed a decision she made two days earlier and ordered Hansen to report to a minimum-security prison farm in

Virginia by 3 p.m. Friday.

Hansen was convicted in 1984 and sentenced to five to 15 months in prison and a \$40,000 fine for withholding personal financial information from Congress. Federal prosecutors charged Hansen omitted \$334,000 in profits, loans and other transactions from financial disclosure forms filed with the House of Representatives under the 1978 Ethics in Government Act.

Mrs. Green agreed with a Justice Department argument Wednesday that a recent decision from the U.S. Court of Appeals precluded Hansen remaining free on bond while his case is on appeal because it was doubtful he would succeed in ap-

pellate court. Stallings, who defeated Hansen for re-election in 1984 by just 170 votes out of more than 200,000 cast in Idaho's 2nd District, said he has seen "absolutely no movement" in efforts Hansen has claimed were under way to clarify congressional intent for the law.

Hansen, 55, said Congress never intended for the law to carry criminal punishment, but Stallings said he agrees with the jail sentence Hansen received.

"What good is a law without some kind of punishment?" he said. Meanwhile, a former field representative for Hansen said he was shocked by Mrs. Green's decision to

order the former congressman to prison. Hansen is the only public official ever convicted under the Ethics in Government Act.

"It's incomprehensible that our system of justice would require somebody to go to prison over trumped-up charges," said John Scoresby of Idaho Falls. "This has been a set-up job from the first. . . . What's ridiculous is that if he never filed a report at all, the only thing which could have done is fine him \$5,000."

Scoresby also blamed the news media for not accurately informing the public about the issues surrounding the case.

"The media has been out to get George," he said. "They have been totally unfair in the last two years, and it has done a great disservice to Idaho and particularly to George and his family."

Falling tree kills Lannen, senator who pushed lottery

PINEHURST (AP) — State Sen. Vern T. Lannen, D-Pinehurst, was killed Thursday when he was hit by a falling tree on a logging project in the Powell Ranger District in Idaho County.

Officials said Lannen, 42, was crushed by the tree about 9 a.m. Others working on the project could not free him in time to save him.

He was transported by helicopter to a hospital in Missoula, Mont., where he was pronounced dead.

The accident occurred near Lowell, which is located near the Idaho-Montana state line. Idaho County sheriff's officials said an officer was investigating the accident scene Thursday night.

Idaho County officials said they were not notified of the accident until 11:58 a.m.

Lannen was employed by North Idaho Jammers. He served his fourth term in the Senate this year from the state's legislative 4th District.

Lannen sponsored a number of proposals in recent

legislative sessions to amend the Idaho constitution to allow establishment of a lottery. He also sponsored legislation this past session that would have authorized the sale of liquor on Sundays in Idaho. That measure did not pass, but counties now have a local option to sell liquor on Sundays.

Lannen, who worked as a lumberjack and mber, has been mentioned in the past as a possible challenger to U.S. Rep. Larry Craig, R-Idaho. Lannen declined to run against Craig in 1984, saying Craig's campaign was too strong with President Ronald Reagan's support.

He served as a two-term Shoshone County commissioner, and also served 12 years as a member of the Panhandle District. He served as chairman of the Panhandle Area Council in 1976-77, and was Northern Idaho's legislative chairman for the Association of Counties from 1974 to 1978.

Lannen is survived by his wife, Judie, and two children.

Judge drops lobbyist's DUI charge

BOISE (AP) — A judge has dismissed a drunken-driving charge against William Roden, an attorney and prominent lobbyist in Idaho representing clients concerned with drinking laws.

Ada County Magistrate Patricia Flanagan dismissed the case Wednesday because the city could not prosecute Roden without evidence that the judge earlier had ruled inadmissible, according to Mona Dobaran, Boise city assistant attorney.

Roden was to have been tried Wednesday.

Dobaran said the city planned to appeal the dismissal.

Flanagan had ruled Friday that field sobriety tests, breath tests and all other evidence obtained after Roden was stopped could not be admitted in the case. Although Boise Police Officer Dave Ginal was acting in good faith, his stopping of Roden was an unreasonable intrusion violating the 4th Amendment protection against unreasonable searches and seizures, she said in the evidence ruling.

Roden, 57, Boise, had not committed any traffic violations and was weaving only minimally in his lane, Flanagan said. According to the judge's recall of the testimony, Roden's car strayed outside its lane once for one-fifth of a second.

Ginal said on his police report that he stopped Roden's car after he saw it drift three times about 6 inches over the lane line for distances of about 10 feet.

After the officer stopped Roden, he made him perform field sobriety tests, arrested him and gave him two breath tests. Roden's blood-alcohol content readings were 0.16 percent and 0.17 percent.

Radiation exposure survey kept on ground

POCATELLO (AP) — A federal survey crew was temporarily grounded Thursday, but expected to begin an aerial study of radionuclide exposure in Pocatello and Soda Springs within the next couple of days.

The aerial tests will begin a two-year study to test the effects of using phosphate slag in area road construction.

Environmental Protection Agency and other officials involved in the survey said Thursday that the helicopter crews will use to monitor ground radiation over the next month will be closely monitored

itself while in flight.

The helicopter will canvass between 70 and 80 square miles in the Pocatello area and 15 square miles in Soda Springs, flying at a steady altitude of 150 feet and covering ground along parallel lines 250 feet apart.

While in flight, the helicopter's course will be charted by a pair of radio receivers, said Holly Berry, a project scientist for EG&G Idaho Inc.'s Energy Measurement division in Las Vegas, Nev.

The twin-engine craft was grounded temporarily while crews worked on some problems with one engine.

The project will be on hold until the backup engine is operating, officials said.

"The maximum delay will be just a day or two," said John Hall of the EPA's Las Vegas office.

Once the testing begins, crews will be at work up to a month. Weather permitting, data will be gathered six days a week.

Information will be picked up by two detector pods at the bottom of the helicopter, and will be transmitted to an onboard computer. The finished product, a contour map of radiation in the region, should be completed by fall.

Malfunctioning swamp cooler may have started store fire

IDAHO FALLS (AP) — Firefighters say they suspect a malfunctioning swamp cooler on the roof of Martin Stationers may have caused a fire that destroyed the business Tuesday night.

Fire Chief Doug Call said damage

to the building, the stationery store and adjacent businesses could exceed \$1 million.

Call said there had been reports of a hot smell around the building earlier in the day. Firefighters say they believe the fire started in the

ceiling of the stationery store at 500 First St.

Jeff Martin, co-owner of the store, estimated the value of lost inventory and furnishings may run between \$500,000 and \$750,000.

PREPARE FOR JULY RODEO'S

Levi's 1497

501's 701's

EXTRA SIZES \$2.00 More



AT THE MERC BLUE LAKES MALL

PRICES GOOD FRIDAY, SATURDAY & SUNDAY

LEVI UNLINED JACKETS \$34.99

Levi's Straight Leg Denim A New Look From an Old Friend Levi's straight leg denim jeans. Cut long and lean — just the way you like 'em. And with heavyweight denim and Levi's quality construction, you can be sure these jeans will be with you for a long, long time. But of course, that's just what you'd expect from a friend like Levi's.

"DAN POST" Boot Sale!

PEGGED STEEL ARCH-LEATHER LINED ALL LEATHER UPPERS CONSTRUCTED FOR LOOKS AND WEAR



YOUR CHOICE \$88

TOP GRAIN COW HIDE Regular \$125.00

BULL HIDE Regular \$135.00

ACME-SALE!



LEATHER FOOT CONSTRUCTION

Widths B-D-EE

Reg. \$59.99

YOUR CHOICE \$44.00

SUNSATONAL Savings at The MERC IN THE BLUE LAKES SHOPPING CENTER PENBROOKE JUNIOR MISSES SWIMSUITS

BIG SAVINGS SPLASH

SAVE 30%

SIZES 7 TO 13 32 TO 38

REG. 17.95 TO 21.95 NOW \$12.56 TO \$15.36

Opinion

The Times-News

William E. Howard
Publisher

William C. Blake
Advertising Manager

Stephen Hartgen
Managing Editor

Michael Gover
Circulation Manager

The members of the editorial board and writers of editorials are Stephen Hartgen and William E. Howard

Leroy hits switch on Pioneer decision

Republican gubernatorial candidate David Leroy has turned up the heat recently in his campaign against Cecil Andrus, claiming an Andrus-era decision not to build the coal-fired Pioneer generating plant on the Snake River was a "no growth decision" for Idaho.

But in our view, Leroy's example is a misplaced one. The decision not to build that plant has turned out to be the right one, in our view, from the perspective of Idaho electric consumers and environmentalists.

It would have resulted, we think, in higher electric rates than what we are paying today, for electric power which is not needed, and with probable extreme impact on Idaho's air quality.

Yes, the plant would have meant construction money and jobs. But to claim that failure to build it has shut off the "growth switch" is not, in our view, correct.

Look at the example of our neighboring state, Washington. The decision to build several electric plants there meant excessive capacity at exactly the point when the use curve for electricity flattened out.

The result was default on the bonds and havoc in the state's supply system.

Leroy should also know that Andrus was not alone in questioning the need for Pioneer's power.

The Times-News, among others, did extensive analyses on the impact and raised substantive questions about the proposal. But none of us are running for governor.

Idaho's economic conditions today wouldn't be solved by a Pioneer plant; indeed, they could well be worse.

The state and the region are subject to conditions from the outside, such as commodity prices, timber usage and foreign competition. None of these would have been solved by a Pioneer coal-fired generating plant.

Andrus, in our view, is vulnerable to other aspects of his record, both as governor and as secretary of Interior. But the Pioneer decision — in which he was only one player — isn't one of them.

Leroy should find another example.

Burger has fine record as chief justice

WASHINGTON — On the morning of May 22, 1969, President Nixon invited a handful of reporters into the Oval Office.

He wanted to talk about his nomination of Warren Earl Burger to become chief justice of the United States. Nothing quite like that conference had ever happened before, and nothing like it has happened since.

"I happen to believe that the Constitution should be strictly interpreted," Nixon said. "Judge Burger is a strict constructionist."



James Kilpatrick

A reporter pressed Nixon for Burger's views on criminal law. Did these views figure in the nomination? Nixon responded candidly. He had read some of Burger's opinions and speeches as a circuit judge. These suggested that Burger would be on the minority side of such 5-4 decisions as *Miranda v. Arizona*. But "I would hope that would become the majority view."

In some ways Burger has disappointed the president who made him chief justice, but that is generally the way of nominees in the highest court in the land.

They won't stay tied. Burger has voted to narrow the *Miranda* decision, but not to overrule it. He has voted to relax the rules under which certain evidence may be admitted in criminal trials, but he has never gone along with repealing the exclusionary rule altogether.

He has indeed been a "strict constructionist," but not an extremely strict constructionist. He was "somewhat troubled" by the majority's opinion in *Roe v. Wade*, the famous abortion case, but he concurred in that bizarre decision.

Tuesday's announcement of Burger's retirement was one of Washington's best-kept secrets of recent years.

If I am not mistaken, Burger will be best remembered not for particular opinions, though, he wrote for the court in such memorable cases as the *Miller* obscenity decision of 1973, but rather for his dedicated labors in judicial administration.

No jurist in our history — not even Taft — has done more than Burger to focus public attention on the court and on the practice of law.

In most areas of his life, Burger is the consummate conservative. He is a man of dignity



"IF WE HAD THIS FIGHT ALL FIXED, WHAT'S BURGER DOING OVER IN THAT CORNER?"

that borders, but never reaches, pomposity. He is a stickler for punctilio, for civility and for courtesy.

"Fixed rules of etiquette and manners are the lubricants of courtroom contests," he once remarked. When his colleagues in 1977 approved lawyers' advertising, he strongly dissented. A firm traditionalist, he has steadfastly opposed television recording of oral argument before his court.

Yet when it came to the administration of justice, Burger was out in the vanguard of change. He regularly fumed at the stilted, medieval procedures of the law.

His annual reports on the state of the judiciary were chronicles of practices that ought to be reformed. He thought bail reform had gone too far. It was time to consider not only the rights of the accused but also the rights of society. He thought legal costs were entirely too high. He campaigned incessantly for new ways to resolve minor disputes without formal court proceedings.

At one point he was advocating small neighborhood tribunals that would be composed of two non-lawyers and a paralegal adviser. He urged the hiring of court administrators. "There

is nothing incompatible between efficiency and justice," he said.

He has pushed other ideas — for a new tribunal just below the Supreme Court, with authority to resolve intercourt conflicts; for the certification of trial lawyers, following the British practice of certifying barristers; for abolition of the jurisdictional rule by which citizens of different states may sue in federal courts. More than anyone else, Burger is responsible for enlargement of the federal judiciary to cope with the "litigation explosion." He has been a leader in forming a federal appellate judicial council in each state. Ten years ago, before it became fashionable, he was advocating tort reform. He once proposed that personal injury suits be settled in the fashion of workmen's compensation. He has fretted at lawyers' abuses of the process of discovery. "He wants higher pay for jurors and more efficient use of their time. He was an early advocate of the Legal Services Corp.

He may not go down in the books as a great or brilliant chief, but assuredly he has been a fine one.

James Kilpatrick writes his column, "A Conservative View," from Washington.

Goldwater won his party, seeded future

WASHINGTON — Zske Bonura was a large and remarkably immobile first baseman whose slowness did not grieve him because he understood a vital principle of baseball: You are rarely charged with an error when you do not touch the ball.

Conservatives have hoped the Supreme Court would adhere to the Bonura Insight, sometimes known as judicial restraint. The Burger Court has not. Indeed, its judicial activism has been as marked as, and arguably more destructive than, the Warren Court's.

None of the Warren Court's most important rulings has been overturned or even significantly circumscribed in the 17 Burger years. The sweep of the *Miranda* ruling on the rights of suspects has been only slightly circumscribed. The Burger Court is responsible for the ruinous spread of forced busing as a "remedy" for segregation.

The Burger Court reinstated the 1964 Civil Rights Act to permit reverse racial discrimination on behalf of government-approved minorities.

Burger Court activism extended procedural due process guarantees to public-school students accused of behaving badly. The Burger Court has done nothing significant to reassess the interpretation of the ban on "establishment of religion" — nothing, that is, to re-establish the principle that government must be neutral between sects, not between religion and secularism.

And nothing the Warren Court did was as raw and radical an exercise of judicial power as the



George Will

1973 decision that swept away the laws regulating abortions in 50 states.

Supreme Court appointments are the premier spoils of presidential politics. Each appointee is a part of a majority at the apex of one of the three branches of government, the branch that has assumed custody of the issues (race, abortion, etc.) the political branches have been pleased to relinquish. The Court is where American public philosophy is published as an unending serial. The departure of Burger, the elevation of William Rehnquist and the nomination of Antonin Scalia are important episodes in the process of lengthening the shadow Theodosius' President will cast into tomorrow.

The Court is a small, face-to-face society where politics has subtle dynamics. The players are strong-willed professionals reasoning about hot issues in the cool climate of a written Constitution, changing statutes and a vast body of case law. The building of coalitions is influenced by intellectual nuance and the power of personality. On both counts, Scalia and Rehnquist will augment the power of conservative jurisprudence.

Scalia is an intellectual in a way that Burger is

not, by training and inclination. Scalia has taught at several of the finest law schools. He has the theoretical turn of mind that deepens analytic powers and does not dispose a judge to try to split all differences. That disposition can make intellectually ineffective politicians but, for a judge, it is an asset. The Burger Court may be less inclined to torture itself, and all who love logic, with ever-more-baroque criteria for distinguishing permissible from impermissible "race-conscious" state action.

No one ever looked more like a chief justice than Burger, who he ever as an infant played in a sandbox must have done so in striped trousers and a swallowtail coat. Rehnquist's clothes come from the factory pre-rumpled. The New York Times locates Rehnquist on "the Court's extreme right wing." ("The Times style book probably says the phrase "the Court's extreme left wing" is an oxymoron.") Actually, Rehnquist has neither the abrasive philosophy nor, as important, the jagged temperament of an extremist.

What he is the keenest mind on the Court, which is why critics complain that he writes too well. When person A can not cope with person B's arguments, A says B is not wise, only articulate. In the administration of the Court, Rehnquist's affability and intellectual effervescence will enhance his effectiveness.

The rise of Rehnquist to the pinnacle of his profession, with the last ascent achieved from the hand of Ronald Reagan, illustrates the geology of our politics. Rehnquist, an Arizonan, was pulled toward public life by the conservative movement energized by another Arizonan, Barry Goldwater, whose 1964 campaign brought political prominence to Ronald Reagan.

Rehnquist serves row with another Arizonan, a law school classmate who was active in state politics, Sandra Day O'Connor. As Barry Goldwater takes his leave of Washington, he sees around him abundant evidence that the significance of 1964 is not that he lost 45 states, but that he won the Republican Party and, doing so, seeded the future.

George Will writes for Newsweek.

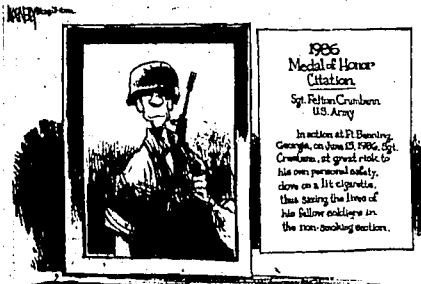

1966 Medal of Honor Citation
Sgt. Robert Crumbrun
U.S. Army
In action at Ft. Dawkins, Georgia, on June 13, 1966, Sgt. Crumbrun, at great risk to his own personal safety, drove on a lit cigarette, thus saving the lives of his fellow soldiers in the non-combat situation.

Letters welcome

The Times-News welcomes letters to the editor but will reject those it considers libelous or in bad taste. Each letter must be signed and should include the writer's mailing address. Letters of more than 400 words may be edited for length.

Letter

Playhouse does it again

Producer Greg Fuller's North Side Playhouse does it again. Under the capable direction of Mike Winterheller, they are giving Magic Valley audiences a chance to again relive the excitement The Music Men brought to River City,

lowa. An evening of sheer entertainment is only 15 minutes from Twin Falls at the Jerome High School. The show is well cast. The music great. The dancers are energetic. The audiences are enthusiastic. How lucky can we get?
MARY COOK
Twin Falls

Botha's declaration starts battle for survival of white elite

JOHANNESBURG, South Africa — South African President P. W. Botha declared more than a state of emergency last Thursday. He declared the start of the deciding battle for the survival of the ruling white elite in this country.

It is a battle that will not end tomorrow, nor even necessarily next year. But its course in the next two months will be etching the patterns of history long after the echoes of the emergency have died away.

The outcome of the battle — black-majority rule — seems most likely. The chilling questions that remain are: How many more lives will it cost? How much longer will it be?

And will a right-wing coup or military takeover lead it first through a bloody gauntlet of attrition?

Botha had five reasons for calling the state of emergency at this time — reasons that go beyond his concern about the Soweto Day anniversary and the threat of so-called communist subversion:

• The president and his government no longer care about foreign censure, believing sanctions to be an inevitability. They would rather be hanged for a wolf than a lamb. Besides, analysts believe that it will take two or three years for sanctions to begin to bite seriously.

Peter Honey

• Botha knows that he needs to offer blacks political power as a way of stopping the violence. But he wants to do it with his own hand. He believes that he can negotiate power-sharing but cannot do it effectively from a position of weakness. At the same time, an one will negotiate with him in a climate of violence and fear.

• The president needs to act swiftly. Within the next six to 12 months he will have to hold an election or a referendum on the black-rights issue. In the meantime his dithering over the black uprising is losing votes to the right.

• The issue of black representation in central government will be the focus of an extraordinary congress of the ruling white National Party in mid-August. By that time Botha hopes to have crushed black agitation, or to have subdued it to the point where he can seek a mandate from his party to begin fighting for black moderates to fill his constitutional creed.

• The sudden rise in white-rightist belligerence has shocked Botha and his party rigid. The National Party, which strode

the political scene unchallenged for 38 years, now has to stalk behind police guards when it holds political meetings in conservative areas.

• He fifth reason, mentioned last because it is cardinal, is the nature of the black challenge itself. This time it will last for ever.

In 1969, after the Sharpeville massacre, the subsequent state of emergency and the suppression of black liberation groups, anti-apartheid protest was forced into obscurity.

It lasted 16 years — until black Soweto school children, unable to stomach the inhibitions drilled into their parents, rose in bloody protest against the injustices of inferior black education.

The uprising sent a ripple of blood across the country. It took the authorities roughly eight months and nearly 700 lives to suppress it. But the seeds of ferment remained.

Which brings us to the events of the last 21 months: 1,700 people killed in an orgy of unappealable horror, thousands detained and a 30-week partial state of emergency, which succeeded as much in politicizing the majority as it did in quelling the manifestation of their outrage.

Now we have a new state of emergency, nationwide, and the government spokesman

says, "We're not kidding, we're serious about this."

There is no doubting the president's assertion that the state has hardly begun to employ the might at its disposal. After all, this is no banana republic. It is, as it professes to be, a regional superpower and is even rumored to have the Bomb.

And it would be foolish to underestimate the devilish ingenuity of people who employ surrogate guerrillas to destabilize hostile governments or vigilantes to crush domestic uprisings of radicalized blacks.

But the black struggle in South Africa now has become a different game. Based on the concept of civil disobedience, it has matured, has wide support and will not easily be suppressed. The government has realized that to late, and has responded in panic with a state of emergency.

But even if the government succeeds in temporarily driving the black opposition underground and Botha steps forward with his carefully prepared plan for power-sharing under white control, black leaders have already rejected that option.

And even if they agreed to it, their supporters are no longer prepared to accept the rule of a government insensitive to black desires.

Violence would break out again, and the

result could be a perpetual state of emergency, with accompanying economic recession and social disintegration.

The white electorate would not tolerate that for long. For the first time the government would be threatened by its own power base.

The scenario has played itself out many times before: A powerful military elite becomes alarmed at the civilian government's inability to cope politically with civil disorder.

In South Africa's case the accumulation of international sanctions has already reduced the influence of foreign powers in the government's internal policy-making. Conservative pragmatists in the military hierarchy, once wary of provoking international isolation, make a deal with right-wing extremists and seize power.

Oppression of the population is magnified, and the country degenerates into civil war — a bloody conflict with time on the side of the majority.

It might be a worst-case scenario, but does it seem less logical than a direct transition from Botha to black-majority rule?

Peter Honey is a South African Journalist based in Johannesburg.

NASA alters Centaur plans

WASHINGTON (AP) — A NASA rifting program to use the space shuttle for launching highly volatile Centaur rockets that propel scientific probes to Jupiter and the sun. A source said the craft will be launched on unmanned rockets instead.

In an announcement, NASA administrator James Fletcher said the agency would examine "other alternatives" for the planetary and scientific payloads scheduled to use the liquid-fueled Centaur upper stage. He said NASA would help the Defense Department examine other alternatives for national security missions designed for the Centaur.

Congressional sources, speaking on condition of anonymity, said the scientific missions would be launched aboard unmanned rockets instead of the shuttle.

Judge's impeachment closer

WASHINGTON (AP) — A House panel took its first formal step Thursday toward the impeachment of convicted federal judge Harry E. Claiborne of Nevada, in what his lawyer vows will be a "no-holds-barred" battle.

Harry E. Claiborne, who had a reputation of scrapping with prosecutors in Nevada, attended the day-long hearing but declined to testify before the Judiciary Committee's subcommittee on courts.

Lawmakers said his lawyer, Oscar Goodman, did the talking for him as the panel heard testimony on whether grounds for impeachment existed.

After the session, subcommittee Chairman Robert W. Kassemeyer, D-Wis., announced that articles of impeachment would be considered by the panel on Tuesday and "I would expect to support them. I would commend two articles" — which would be akin to a two-count indictment.

Claiborne was flown to the hearing from the minimum security federal prison camp at Maxwell Air Force Base in Montgomery, Ala., where he is serving a two-year sentence.

FHA exhausts credit again

WASHINGTON (AP) — The Federal Housing Administration, its credit ceiling exhausted for the second time this year, stopped taking new mortgage applications Thursday while a dispute in Congress held up a bill to put it back in business.

The legislation to extend FHA's statutory authority that lapsed June 3 and raise its credit ceiling was held up by a dispute over this month's scheduled distribution of \$99 million worth of federal Urban Development Action Grants.

Sens. Strom Thurmond, S.C., and Charles Grassley, R-Iowa, had sought to delay the distribution of the grants until a new formula favoring cities in the South and West becomes law.

But late Thursday afternoon, Grassley and Thurmond dropped their efforts to amend the FHA bill when it became clear the House would not give way on the issue, spokesmen for the lawmakers said.

AMA drops alcohol ban drive

CHICAGO (AP) — The American Medical Association on Thursday stopped short of supporting a ban on broadcast advertising of alcohol and a mandate for health warning labels on alcoholic beverage containers.

Instead, the association resolved to work to stop alcohol ads directed at youth and to persuade manufacturers to put labels on containers telling alcohol's inherent dangers to certain groups, such as to pregnant women, and its dangers to all if abused.

"Our problem with alcohol is alcohol abuse," Kirk Johnson, general counsel of the AMA, said after the organization's policymaking House of Delegates voted on the issue during the final day of its annual meeting.

Comprehending the issue with smoking, a day after the AMA resolved to work for a ban on smoking on airlines and on tobacco sales to people younger than 21, Johnson said alcohol is "just a different ball game."

Smoking, cervical cancer tied

CHICAGO (AP) — Women who smoke heavily or who smoke non-filter cigarettes are much more likely to get cervical cancer than non-smokers, according to a study in Friday's Journal of the American Medical Association.

Women who smoke unfiltered cigarettes, women who smoke at least two packs a day and those who have smoked for 40 years or more were twice as likely as non-smokers to get the deadliest form of the most common kind of cervical cancer, the study found.

Intermittent smokers and women who had quit smoking at least two years before the study were found to have the same risk as non-smokers, the study reported.

Louise A. Brinton, an epidemiologist at the National Cancer Institute in Bethesda, Md., and medical researchers conducted the study of 1,277 women between April 1982 and January 1984 in Chicago, Denver, Miami, Philadelphia and Birmingham, Ala. Of those, 489 had the cancer and 797 did not.

Scalia's rulings under attack

WASHINGTON (AP) — A liberal foundation said Thursday that the court decisions of Supreme Court nominee Antonin Scalia reflect "steadfast opposition to basic individual and press rights."

In the first of a likely barrage of attacks from liberal groups, Supreme Court Watch said Scalia's record since he joined the U.S. Circuit Court of Appeals for the District of Columbia in 1982 "raises questions about whether his political agenda is in conflict with the traditional model of open-minded and disinterested decision-making required of members of the U.S. Supreme Court."

In four areas — libel, government secrecy, race discrimination and foreign policy — the group said Scalia "has often voted for the conservative (at times the extreme conservative) view."

"Judge Scalia has repeatedly ruled against journalists in libel cases," the analysis said.

Cokeville school given award

COKEVILLE, Wyo. (AP) — The state Board of Education has honored the children and faculty of Cokeville Elementary School with a Wyoming Award of Excellence.

State Superintendent of Public Instruction Lynn Simons on Thursday said the award will be given out annually to a school that shows exemplary service. She called the award the first of its kind and well-deserved by the students, teachers and staff of the rural public elementary school on the southwestern Wyoming border.

Last month, a couple held 150 people hostage in the first-grade classroom of the school. Doris Young and David Young asked for \$300 million for the safe return of the teachers and students.



RICHARD W. MILLER
Jury rejects claim

Ex-agent convicted of spying

LOS ANGELES (AP) — Richard W. Miller, the only FBI agent ever accused of spying, was convicted of espionage and bribery Thursday by a jury that rejected his claim that he was trying to infiltrate the Soviet KGB as a double agent to save his flagging career.

Miller, the pudgy agent who worked in the counterintelligence section of the FBI's Los Angeles office, sat motionless and stared at the jurors as the verdict was announced in the case that rocked the FBI when it broke nearly two years ago.

Miller, 43, could be sentenced to life in prison. Miller was arrested and charged with spying in October 1984 with his lover, Svetlana Ogorodnikov, and her husband, Nikolai. The Ogorodnikovs, both Soviet emigres, pleaded guilty in the espionage case and were serving prison sentences.

Miller was found guilty of conspiring to pass classified documents to the Soviet Union, of copying classified documents and of delivering them to a foreign government with knowledge they would be used to the advantage of a foreign power, the Soviet Union, and to the disadvantage of the United States.

He also was found guilty of communicating the documents to a known representative of the Soviets, and of soliciting \$50,000 in gold and \$15,000 in cash.

The panel had told the judge they were deadlocked on one count only, whether or not Miller had accepted an expensive trench coat from Mrs. Ogorodnikov as a bribe. The government moved to drop the seventh count, and U.S. District Judge David Kenyon granted the motion.

As Miller was being led out of the courtroom in handcuffs, he was asked for comment by reporters. He smiled and said: "Let's say thank God for the court of appeals."

Miller's attorneys, Joel Levine and Stanley Greenberg, said they were confident the verdict would be reversed on appeal.

Sexual harassment at work illegal, Supreme Court rules

WASHINGTON — The Supreme Court ruled Thursday that on-the-job sexual harassment is illegal even if its victims are not hurt economically.

The court also said employers are not always liable when, unknown to them, supervisors sexually harass workers.

The decision immediately was hailed by feminist groups as an important, if qualified, victory for working women nationwide.

By a unanimous vote, the court said a federal law banning sex discrimination in employment applies to sexual harassment that creates a "hostile environment." The decision upheld a standard previously adopted by the federal Equal Employment Opportunity Commission.

Writing for the court, Justice William H. Rehnquist said nothing in the disputed law, known as Title VII of the Civil Rights Act of 1964, "suggests that a hostile environment based on discriminatory sexual harassment should not be ... prohibited."

It was the first opinion released under Rehnquist's name since Pres-

ident Reagan announced on Tuesday his intention to appoint him as chief justice to replace the retiring Warren E. Burger.

In other decisions, the court: Ruled unanimously that states and local governments may not withdraw their employees from the nation's Social Security system.

The decision in a California case is a victory for the Reagan administration, which told the justices that \$3 billion could have been drained from Social Security by 1990 if such withdrawals were allowed.

Ruled, 5-4, that people who carry guns while committing crimes may be punished with stiff minimum prison sentences even though there is minimal proof of possession. The ruling upheld a Pennsylvania law imposing a minimum five-year sentence for such offenses.

The sexual-harassment decision clears the way for new proceedings in a lawsuit filed against the District of Columbia-based Meritor Savings Bank, now known as PSPS Savings Bank, by Mechelle Vinson.

A former assistant branch manager, Vinson sued the bank and her ex-supervisor, Sidney L. Taylor.

Her suit contended that she had consented to having a sexual affair with Taylor over the course of several years "for fear of losing her job."

Vinson testified that she never told any of Taylor's superiors because she was afraid of him.

Taylor denied all of Vinson's allegations.

Vinson currently is studying for a nursing degree and hopes to continue her schooling toward a Ph.D. in psychology.

"I'm very excited," said Vinson, 31. "I was amazed, and very pleased."

Rosalie Gault Silberman, a member of the Equal Employment Opportunity Commission, said: "Today's decision unanimously affirmed the principle that the workplace must be free of sexual harassment, be it harassment in the form of economic harm or a poisoned work environment resulting in psychological harm."

"This is a tremendous victory for working women," she said. "We are particularly pleased that the court relied so heavily on the commission's guidelines and the government's brief."

D & B SUPPLY
sidewalk sale

1 DAY ONLY

SATURDAY, JUNE 21
8:30 A.M.-5:30 P.M.

MOST ITEMS BELOW COST

TOOLS - CLOTHING - LAWN & GARDEN SUPPLIES - USED TIRES & WHEELS - MISCELLANEOUS

HUNDREDS OF ITEMS !!! ALL MUST GO!!!

PLUS!



RC, DIET RC, CHERRY RC, 7-UP, DIET 7-UP & DR. PEPPER \$1.47 6 pack 12 oz. cans

D & B Supply Co.

8:30-5:30 Daily • 10-4 Saturday
Rt. 3 Addison Ave. E. • 208-733-9233

JOHN A. DOERR & KEVIN F. TRAINOR
are pleased to announce the association with them & **JACQUELINE S. WAKEFIELD** of **BRIAN D. HARPER** in the general practice of law under the firm name of **DOERR & TRAINOR**
184 Second Street West, Twin Falls, Idaho 83301
208-733-4961

Just a Reminder:
IT'S COLLECTION WEEK



Your Times-News Carrier is collecting this week. Please have your cash or check ready.
THANK YOU
The Times-News

Permanent Paving



- Parking Lots
- Driveways

"20 Years Experience"

733-4335

OR

733-9352



World

Peruvian forces take control of prison; death toll tops 250

LIMA, Peru (AP) — Marines took control of El Fronton prison Thursday after a nearly 24-hour battle with guerrilla inmates, and at least 250 prisoners died there and in battles at two other prisons, a high-level government official said.

The inmates at El Fronton, a barren island five miles offshore from Callao port near Lima, had used guns, explosives and homemade bows and arrows in their battle with the marines.

The military command said troops had regained control of Lima's Lurigancho prison and the Santa Barbara women's prison in Callao Thursday morning.

But the fighting raged at El Fronton until late afternoon. About 250 inmates were killed in the fighting at the three prisons, said the high-level government official, who spoke on condition of anonymity.

Questioned about news reports that more than 450 prisoners had been killed in the fighting, he said, "That is too much. It was about 250."

The official is close to President Alan Garcia.

He did not give a breakdown on the casualties for each prison.

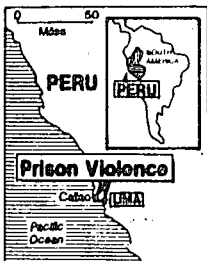

Prison Violence

Military communiques earlier reported "a great number of dead" at Lurigancho without being specific. An anti-riot captain said soldiers apparently stormed Lurigancho with "the intent to kill everyone" and he saw dozens of bodies stacked against a wall.

The official said earlier that three naval officers were killed at El Fronton, and two women prisoners were killed at Santa Barbara.

Riots at the three prisons began early Wednesday.

The captain of the anti-riot force, who spoke on condition of anonymity, told an Associated Press reporter outside Lurigancho: "They haven't left anyone alive."

He reported seeing the dozens of bodies piled up against a wall on the far side of the compound and said Antonio Diaz Martinez was among the dead, "half his face shot away by a machine-gun blast."

Diaz Martinez was considered third in command of Shining Path, a Maoist group founded by philosophy professor Abimael Guzman that has been fighting a guerrilla war for six years.

The government had established a virtual news blackout on the riots, issuing only four communiques after marines and army troops began moving Wednesday evening on the prisons, where more than 500 inmates accused of belonging to the Shining Path were held.

President Garcia met this week with newspaper publishers and television directors to get them to play down their coverage of leftist terrorism. Peru is playing host to hundreds of delegates arriving for a meeting of the Socialist International in Lima.

U.S. praises Panama's help

WASHINGTON (AP) — The Reagan administration told Congress Thursday that Panama is providing useful cooperation against drug trafficking and money laundering and sought to disassociate itself from a published report alleging personal involvement by the chief of Panamanian armed forces in such activities.

James H. Michel, deputy assistant secretary of state for Inter-American Affairs, denied suggestions that the administration had deliberately leaked accusations against Panamanian General Manuel Antonio Noriega which appeared last week in The New York Times and were attributed to U.S. government sources.

"No one that we know of, no one with the authority of the U.S. government" provided the information

to the newspaper, Michel told the House of Select Committee on narcotics abuse and control.

Committee chairman Charles B. Rangel, D-N.Y., suggested that the accusations against Noriega, following public charges by the U.S. Commissioner of Customs William Von Raab of corruption in Mexico, represented a "not well thought out strategy" against countries opposing U.S. policy in Central America.

Talking to reporters after four hours of closed anti public testimony to his committee Thursday, Rangel said the Central Intelligence Agency, during the secret hearing, had "shed no light" on the allegations against Noriega.

Last week's New York Times story said the Panamanian general was involved in sales of secrets to Cuba, gun-running to Colombia, trafficking

in narcotics and laundering money for his personal gain.

On Wednesday, The New York Times published an interview with Noriega in which he denied all charges of involvement in criminal activities.

Rangel said he concluded from intelligence presented to the closed session of the committee that "there is no reason to believe that whatever problem they (the administration) see will be improved by replacing Noriega."

John Cusack, chief of the committee's staff, told reporters that the secret testimony "did not confirm or deny" the Times' report.

Michel and other administration witnesses told the House panel that the Panamanian government has eradicated through spraying about half of its domestic marijuana crop.

S. Africa orders new curfews

JOHANNESBURG, South Africa (AP) — Police used their emergency powers Thursday to impose curfews on dozens of black townships.

Strikes spread among black workers who demand that their union leaders be released from jail. Bishop Desmond Tutu took the archbishop of Canterbury's special envoy, Terry Waite, to the courtroom wedding of a black activist who is on trial for treason.

White voters in Port Elizabeth, an auto manufacturing center on the Indian Ocean, voted 6,104 to 4,957 against integrating their beaches.

Government spokesman Leon Mellet said in Pretoria that three more people were killed in unrest, including a white man missing since last weekend, bringing the total to

48 in the week-old state of emergency.

Two of the victims were blacks slain by other blacks in a tribal homeland, while the third, a badly burned body found in a black township near Uitenhage, was identified by Michel as that of Lodewyk Vlooh. No details on Vlooh's death were disclosed.

Foreign Minister R.F. Botha said a U.S. House of Representatives vote to impose a total trade embargo and order all American companies out of this country showed a disregard for the welfare of South Africa's blacks.

In London, the human rights organization Amnesty International issued a statement saying five whites were arrested last Saturday

in Port Elizabeth by security police while attending a briefing with a lawyer on the terms of the state of emergency. Those taken into custody included a mother of two, Amnesty said.

The new curfews in dozens of townships around Port Elizabeth, Uitenhage and other south-central industrial centers, ran from 9 p.m. to 4 a.m. Police also prohibit possession of T-shirts or other articles bearing the names of any of 47 anti-apartheid and civic organizations.

Authorities had said Port Elizabeth townships produced the worst violence in the country Monday, when blacks mounted a general strike to commemorate the 16 anniversary of bloody riots in Soweto.

Soviets sentence Fedorenko to death

MOSCOW (AP) — Fyodor Fedorenko, the first person deported to the Soviet Union from the United States on Nazi war crimes charges, was sentenced to death Thursday in a Crimea court after his conviction for treason and mass murder.

The official news agency Tass announced the Thursday conviction and sentencing of the 78-year-old Fedorenko, a former Red Army soldier captured soon after the Nazis invaded the Soviet Union in 1941.

He was tried by a court in the Crimean capital of Simferopol, about 115 miles south of his hometown of Dzhankoye. The news agency did not say when the sentence might be carried out, or whether Fedorenko will appeal.

It is common for those convicted of treason to be sentenced to death.

Tass said Fedorenko, who served as a guard at the Nazis' Treblinka death camp in German-occupied Poland from 1942 and 1943, was found guilty of treason, voluntary transfer to the Nazi side in World War II, and participation in mass murder of foreign citizens.

The indictment read at his trial when it opened June 10 also said he served as a guard at two other Nazi camps and fled to Hamburg, Germany, before the war ended.

According to Soviet estimates, at least 300,000 people were murdered at Treblinka alone in 1942 and 1943.

Italian office bomb target; pair injured

ATHENS, Greece (AP) — A powerful time bomb exploded Thursday outside an Italian business office, blowing out doors and windows and injuring two people.

A second explosive planted at the Italian consulate failed to go off. Police sources, speaking on condition of anonymity, said they believed the bombs were linked to the trial in Italy of 15 people in the Achille Lauro cruise ship hijacking.

An Italian employee was slightly injured by a falling bookcase in the 1:15 p.m. blast outside the Italian Chamber of Commerce fifth-floor office in Athens, police said. A Greek man passing outside the building, was cut by flying glass.

On Wednesday, in Beirut, an anonymous caller claiming to speak for the Palestinian guerrilla force headed by Abul Abbas told a Western news agency that the group would strike Italian targets because of the trial.

Abul Abbas, who heads the Palestine Liberation Front, is accused of masterminding the Oct. 7 hijacking off the coast of Egypt in which Leon Klinghoffer, a crippled 69-year-old American passenger, was killed.

Comedian killed

PARIS (AP) — Coluche, one of France's best-known comedians, died Thursday in a motorcycle accident in southern France, his agent said. He was 41.

The comedian, whose real name was Michel Colucci, was a motorcycle enthusiast who set a new world speed record in the 750 cubic centimeter class on an Italian track on March 19, 1985.

He was known for his impertinent, often vulgar humor, and staged a mock campaign for president in 1981.

32 Brand New HONDAS

Just arrived.

All colors, all specially priced!

THEISEN MOTORS

701 Main Ave. E. 733-7700

"We take the time to make your glasses right . . ."

BACK BY POPULAR DEMAND

50% OFF LENSES

Now thru July 3, order a complete pair of prescription glasses, and all lenses including single vision, bifocal, and even tri-focal are half the regular price. Scratch resistant protective coating and other special items available at normal cost.

No other discounts apply.

Soft Contact Lenses

Daily Wear \$49.50

Includes: R21, DuraSoft, CIBA, and Amoco, all Hydrus. Contact lens kits are included at no extra cost. Other brands, torics, bifocals and specialty lenses available at nominally higher prices.

Royal Optical

Complete Optical Service

151 Main Ave. West 733-8688 Open Sat. 'til Noon

SAVE UP TO \$2.00

With proof of purchase from 1.75 liter or 750ml bottles, this refund slip or peek up to at your liquor store.

IMPORTED CANADIAN MIST

CANADA AT ITS BEST

(Canadian Mist Refund), 1517 Bow Tower, New Augusta, NS B2N 2Y1

The proof of purchase symbol is located on this label to ensure a simple cut around dotted lines. Limit 1 bottle per household. 1 bottle per household.

Amount of Refund: Check One

\$ 1.00

With 1 proof of purchase from either a 2.0 liter or a 1.75 liter bottle.

\$ 2.00

With 1 proof of purchase from a 1.75 liter bottle.

Please allow us to right week for delivery of refund check. Not open to employees, agents or representatives of any alcoholic beverage licensee or B-1 Spirits Ltd. Must be purchased for personal use. Offer limited to adults of legal drinking age. IMPORTED BY B-1 SPIRITS, LTD., LOUISVILLE, KY. CANADIAN WHISKY - A BLEND. B00FCR3 1986 MAIL-IN REFUND OFFER...EXPIRES 9/30/86.

Hudson's Shoe Store

DOWNTOWN & LYNWOOD TWIN FALLS

GIGANTIC SHOE SALE CONTINUES!!!

ON MEN'S AND WOMEN'S SHOES

Save Up To

75%

Two Locations to serve you... Downtown & Lynwood

Bank Cards and Charge Accounts Welcome

Recipient Haydon dies after 488 days on an artificial heart

LOUISVILLE, Ky. (AP) — Murray P. Haydon, a retired auto worker who lived 488 days with a Jarvik-7 mechanical heart, died Thursday, leaving only one survivor among the five men who have received permanent artificial hearts. He was 59.

Haydon died at 3:45 a.m. MST, said Tom Noland, a Humana Hospital Audubon spokesman. He declined to say if Haydon's wife, Juanita, and their three children were with him.

Last week, Haydon's brain and lungs began deteriorating and there was little hope he would recover, said Dr. Allan Lansing, medical director of the hospital's Heart Institute.

Haydon's family decided against placing him on dialysis to help his failing kidneys because they did not feel it would improve his quality of life, Lansing said.

Noland said other details would be released later at a news conference attended by William DeVries, the surgeon who implanted all four per-



MURRAY P. HAYDON
Retired auto worker

manent artificial hearts used in the United States.

Haydon's attitude remained very

good in his last days, "and he continued to enjoy life," DeVries said in a statement. "We came to know him not just as a patient but also as a good friend."

Haydon was the third recipient of a Jarvik-7 heart and second longest-living. He received his heart on Feb. 17, 1985, and had spent most of his time since the hospital's intensive care unit. He required a respirator to help him breathe much of the time.

William Schroeder's heart was implanted Nov. 25, 1984, and he is still a patient at Humana Audubon. Barney Clark died 112 days after he received the first Jarvik-7 implant, on Dec. 2, 1982.

Leif Stenberg, 53, of Sweden received an artificial heart April 7, 1985, and died Nov. 21. Jack Burcham became the fifth recipient April 14; he died 10 days later.

"The contributions of these individuals, like Haydon, have been enormously beneficial in leading us to a better mechanical device and

improved patient treatment post-operatively," DeVries said in his statement.

"There's no doubt in my mind their participation in this research will help save thousands of lives in the future," DeVries said.

Haydon left the hospital only three times, visiting neighbors in January, taking a van ride the next month and stopping briefly at his suburban Louisville home in March.

DeVries' implant program has come to a standstill because of fewer patient referrals, stricter federal regulations and virtual abolishment of age limits for patients to qualify for heart transplants.

On Jan. 8, the U.S. Food and Drug Administration adopted new restrictions on the Jarvik7, including case-by-case approval of further implants, new procedures for treating patients and periodic reports to the government on patient status.

Haydon, a retired auto assembly line worker known to friends as "M.P.," had battled car-

diomyopathy, a progressive deterioration and swelling of the heart, since 1981. In January 1985 his children asked family physician Jerome Lacy about the possibility of an artificial heart.

"They had seen Haydon wasting away and becoming exhausted from such simple tasks as brushing his teeth," Lacy said, who contacted Humana Heart Institute - International.

Haydon was approved as a candidate Feb. 14, after doctors agreed he could live only a few days longer without the Jarvik-7.

The family was aware of the risks, such as the strokes that had struck Schroeder, the world's second recipient of a mechanical heart.

Surgeons speculated the strokes may have been caused by blood clots forming around the plastic-and-metal heart.

"A lot of people have strokes. A lot of people have fever and colds and that's the way we feel about it," Juanita Haydon, Haydon's wife of 32

years, said before the implant.

Haydon made satisfactory progress until blood began accumulating in his chest. On March 2, 1985, surgeons closed a tiny opening inside Haydon's chest and returned him to a respirator.

Most of the time Haydon was tethered to the 323-pound Utahdrive that supplied the compressed air to power the Jarvik-7. He also used the portable Heimes drive.

Haydon spent seven years in the Army and Air Force. He operated a barber shop with an uncle, then worked at the Ford Motor Co. Kentucky truck plant for 14 years before retiring in June 1983 for health reasons.

He was described by friends and relatives as a quiet man, always willing to lend a helping hand. He had a passion for history and geography, and enjoyed working puzzles.

In addition to his wife, Haydon is survived by a son, two daughters and five grandsons, including one born two days before his implant surgery.

Utah doctors see benefits from artificial organs

SALT LAKE CITY (AP) — Longer and more comfortable lives will become possible for recipients of artificial hearts, two University of Utah physicians long involved in artificial organ experimentation said Thursday.

Despite the death of artificial heart patient Murray Haydon Thursday morning, pioneering

researcher Dr. Willem Kolff said the fact that the retired auto worker survived more than a year was an important sign of progress for the implant.

"I don't think any of the critics would have believed that anyone could live on an artificial heart this long," said Kolff, who retired this year as chief of the university's div-

ision of artificial organs but is still active in research.

Kolff said he is working on a possible solution to the problem of blood clotting, which is suspected in strokes suffered by the first artificial heart patient, Barney Clark, and the longest-living recipient of the device, William J. Schroeder.

However, Kolff said the perfor-

mance of the artificial heart, first implanted in Utah in December 1982, was better than that of human heart implants after the same amount of time.

"If you compare the results of the artificial hearts in the early days to the early heart transplants, the artificial heart has done much better," he said.

"I'm sorry (Haydon) died, but I don't think he was very happy," Kolff said. "Give it a little time and the quality of life will be much better. In the meantime, the heart can be used as a bridge to transplantation."

TWIN FALLS FOOT CLINIC
Children • Adults • Athletes
Dr. Peter Rickards, D.P.M.
141 Blue Lakes N • 734-3338

Priest recalls clear quality of Kate Smith's voice at mass

RALEIGH, N.C. (AP) — About 200 people mourned singer Kate Smith at a funeral mass on Thursday, and a priest recalled the "almost perfect, bell-like quality of her voice" that was a gift from God.

"No one ever had any difficulty in understanding every word that she had to sing," Monsignor James McSweeney told those gathered at Our Lady of Lourdes church.

"Miss Smith, who popularized the patriotic song 'God Bless America,' died Tuesday at 79 of respiratory failure.

Her singing career lasted 50 years, until she was stricken with a diabetic coma in 1976 that made it difficult for her to walk or talk. Diabetes forced the amputation of her right leg above the knee in January, and she underwent a mastectomy May 9.

"What heaven has gained, we have individually lost. . . . I remember thrilling to her voice," McSweeney said.

"Everything was plain, in that almost perfect,

bell-like quality of her voice that has been so much a part of our lives," he said. "The beauty of her voice, the phrasing of the words — her talent was a gift from God."

Among the mourners were her sister, Helena Steene, and Miss Smith's two nieces.

Six pallbearers brought the casket into the high-ceilinged, modern sanctuary as an honor guard of 10 Knights of Columbus stood by in black capes trimmed in red, yellow, green and white and hats with colored plumes.

"God Bless America" was not played at the mass, but several American flags were displayed outside the church.

Her body was to be flown to Washington for a Saturday funeral mass, with burial in Lake Placid, N.Y.

Gov. Jim Martin, who ordered flags on state buildings to fly at half-staff until Saturday, called her "a treasure to this country and this state."

mañe of the artificial heart, first implanted in Utah in December 1982, was better than that of human heart implants after the same amount of time.

"If you compare the results of the artificial hearts in the early days to the early heart transplants, the artificial heart has done much better," he said.

Rivers in surgery for 2 procedures

LOS ANGELES (AP) — Comedienne Joan Rivers underwent surgery Thursday for a hysterectomy and a tummy tuck, a spokesman said.

Miss Rivers, 53, decided to have both procedures done at Cedars-Sinai Medical Center, said her spokesman Richard Grant.

Grant would not disclose the reason for the hysterectomy, which involves removal of the uterus. The tummy tuck will help eradicate the hysterectomy scar, he added.

Miss Rivers is expected to remain in the hospital for about a week, said Grant. She will return to her Beverly Hills home to complete recovery before flying to London on July 20 to cover the wedding of Prince Andrew for ABC-TV's "Good Morning America."

Driving To Denver & Flying Out? STAY WITH US !!

Quality Inn

North

COMPLIMENTARY LIMO SERVICE TO & FROM AIRPORT

DENVER
1-25 & 104th Ave.
Toll Free 1-800-925-8111

ACROSS FROM NORTHGLENN MALL

FROM
SGL...\$35 DBL...\$39

Restaurant & Lounge

COMPLIMENTARY:
Cocktail • Continental Breakfast • HBO Cable TV
In Room Coffee • Sauna • Heated Pool • Jacuzzi

LAST 3 DAYS

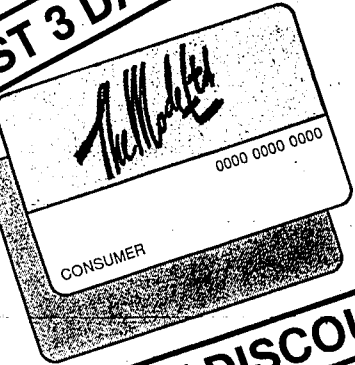

MYSTERY DISCOUNT

SAVE 10%-30%
When you open a new account or are already a charge customer.

How it works:

Use your MasterCard, Visa or American Express to open a Mode charge account during MYSTERY DISCOUNT, Monday, June 16 through (and including) Sunday, June 22nd.

Stop into our office, fill out an application and on approval of credit - pick up your mystery discount coupon for savings of 10%, 15%, 20% or 30%.

If you already have a Mode Charge account, remember to use your MYSTERY DISCOUNT!

The Modelists

MALL HOURS:
Mon.-Fri. 10:00-9:00
Sat. 10:00-6:00
Sun. 12:00-5:00
BLUE LAKES MALL

*Romance:
It can be Simple
But Still Lovely*



Dress with extended sleeve with scallop edging, button placket front and drop yoke. Pastel pink embroidery on white cotton. Sizes S, M, L. 32.00.

The Paris
Top-of-the-Paris

124 Main Avenue North, Twin Falls • 733-1506 • Open Mon.-Sat. 10:00 A.M. to 6:00 P.M.

BLUE LAKES

MALL

And Shopping Center

MALL HOURS:

Mon.-Fri. 10 a.m.-9 p.m.

Saturday 10 a.m.-6 p.m.

Sunday Noon 'til 5 p.m.

(some stores with extended hours)

The Mall will be open

July 4th from Noon 'til 5 p.m.

C. W. Woodhead & Co.

ART & CRAFT SHOW June 20th-29th



In Action:

Paintings

Sculpture

Pottery

Glass Blowing

Photography

Woodworking

Leathercraft

AND
MANY
OTHERS

Professional Artists & Craftsmen from the Western United States!

***** Upcoming Mall Events *****

Wills Motor Co.
New Car Display
in the Mall

New Product
On Display in the Mall!
PULSATING
MASSAGE PILLOW

June 30-July 6

Bring Your
Pressure Canner Lids
for testing to the Mall

July 10th
10 a.m.-3 p.m.

Blood Pressure Clinic
SUMMER SCHEDULE
at the Mall

June 24th July 22nd
Aug. 19th Sept. 16th

Please keep those dates in mind.

Windy weather hampers 'hopper spraying

By FLYNN McROBERTS
Times-News intern

TWIN FALLS — Winds and cool temperatures all but stopped grasshopper spraying in Idaho Thursday, with only 216 acres covered in Owyhee County, according to the U.S. Department of Agriculture's Animal and Plant Health Inspection Service officer in charge of the estate.

Officials had planned to cover 1,500 acres near Malta and additional land in Jerome County on Thursday, but were delayed by uncooperative weather, Roger Pollard said. Wind also cut short spraying in Owyhee County, where planes dropped only 13 1/2 gallons of pesticide, he added.

A pilot for Reeder Flying Service in Twin Falls said winds were the major problem. With gusts over seven mph, "You can't do a

'We would have much more concern — for both water quality and public health — if they were (spraying) every two or three weeks.'

— Mike McMasters

good job, and it's rough flying," he said. Today's efforts were expected to be minimal due to continued poor conditions. "The weatherman still says cool and windy," Pollard said. "It isn't very good Malathion weather."

Contractors employed by APHIS in the

'hopper attacks have been alternating between Malathion and Sevin-4 Oil — the only two chemicals approved by the Environmental Protection Agency for the grasshopper spraying program.

Although Malathion costs less than Sevin-4 Oil, it lasts for a shorter period. In addition, it doesn't work as well in cold and rainy weather and doesn't have the "wash-off resistance" of Sevin-4 Oil, Pollard said. APHIS tries to change chemicals if the weather calls for it, "but it's not that easy," Pollard said. "Some contractors don't have the chemicals to switch."

Concern over the use of both Malathion and Sevin-4 Oil has sparked protests from environmental groups in Oregon, said Mike McMasters, source control field officer with the state Department of Health and Welfare's Division of Environment in Twin Falls.

But officials here, he added, are not alarmed by the use of the chemicals because spraying is mainly in "one-time shots."

"Our concern would be if there were no controls on spraying on surface waters," he said, pointing out that APHIS has said it will try to avoid doing so.

Although a "reasonably large dose ... could create some problems as far as toxicity for aquatic insects," McMasters said, "We would have much more concern — for both water quality and public health — if they were (spraying) every two or three weeks."

"If sprayers themselves use a buffer strip" between rangeland and water sources, "there shouldn't be much problem," he said.

Locustae to fight grasshoppers where chemicals cannot be used, said Jon Idso, Shoshone district manager of the U.S. Bureau of Land Management.

"It's a new approach, and it's somewhat experimental," Idso said. "But it will be closely monitored" by officials from the University of Idaho.

Planes are set to begin spraying the substance Saturday morning along the Little Wood River, tentatively from Richfield to the Lincoln-Blaine County line.

One of the purported advantages of Nosema Locustae is its selectivity; it supposedly kills only a couple strains of grasshoppers, Idso said.

In additional chemical spraying plans, large tracts in the Picebo Hills area of Blaine County are scheduled to be covered next week, he said, but the effort is primarily to protect wildlife and not cropland.

Interview room receiving donations

By PAT MARCANTONIO
Times-News writer

TWIN FALLS — More than \$1,200 in cash has been donated toward the furnishing of an interview room for young victims of abuse.

A \$1,200 donation was provided this week by the Florence M. Gardner Foundation of Twin Falls, said Sandy Chilese, a case assistant with the Twin Falls County Prosecutor's Office.

Prosecutor K. Ellen Baxter asked the public on May 15 for \$5,000 in donations to furnish a room provided by the Twin Falls Clinic. The room will be designed to look like a playroom to ease the trauma of children while they are being interviewed by law-enforcement personnel about incidents of abuse.

The foundation donation will be used to purchase video tape equipment for recording interviews, Chilese said.

The Magic Valley Pioneers, a service organization comprised of Mountain Bell employees and retired employees, already had donated a color television monitor valued at \$300. Mel Quile's Electronics in Twin Falls provided a discount on the set, said Sandy Kiser, co-president of the group.

The organization also donated another \$200 worth of art supplies, books and more than a dozen stuffed animals.

Mountain Bell employee organizations in the Western states last year had decided to support child-abuse prevention projects, Kiser said.

Other individuals also have played Santa Claus by donating toys to the project.

Carolee and Reed Walker of Twin Falls donated two doll houses and furniture for the houses, Chilese said. One of the houses was assembled by residents at the Port of Hope substance abuse treatment center.

The Walkers also donated some dolls.

Volunteers Against Violence, a Twin Falls group aiding victims of domestic violence, contributed three dolls, several doll outfits and two handmade toy trucks.

• See ROOM on Page B2



Prosecutor K. Ellen Baxter has toy donations coming in for the new interview room

Unexpected funds help senior center

By ANNETTE CARY
Times-News writer

TWIN FALLS — A surprise receipt of \$38,534 in Community Development Block Grant funds is easing the remodeling budget at the new Twin Falls Senior Citizens Center.

The city of Twin Falls had applied for a \$100,000 block grant in 1985 to remodel the old KMYV-TV studios on Eastland Drive into a senior center, after parts of the center on 4th Avenue West were condemned.

The state approved the project, but had used most of its funds by the time money for the Twin Falls center was appropriated. Only \$41,412 remained to pass on to Twin Falls.

Now, a year later, the state has added nearly \$40,000 to Twin Falls' original grant award. The money comes from what remained of the 1985 block grant fund the federal government required the state to keep on hand for emergency projects.

It gives the seniors a total of

about \$135,000 to spend on remodeling. That includes \$79,949 in block grant awards, \$25,000 from the sale of the 4th Avenue West property and \$30,000 saved by the seniors for a building fund.

The senior center is still looking for civic groups willing to volunteer work, in order to keep the cost of construction down, says Director Thelma Ross. But with the additional grant money more remodeling may be possible than originally estimated in the first phase of construction, she says.

Only the newest part of the building will be used initially. Plans call for converting the two studios into dining areas. A 110-foot ramp will be built from the rear entrance to the basement for access to a recreation hall and lounge.

Initial remodeling plans also call for an office, a restroom, a kitchen and a new roof.

The first phase of construction is well under way, and seniors are pressing for a July 17 opening, Ross says.

Grant denial places Gooding park on hold

By JANENE BUCKWAY
Times-News correspondent

GOODING — A proposed industrial park in northeast Gooding is on hold following failure of the city to receive a community block grant for its development, city officials said this week.

The city had applied for a \$253,000 grant to develop a 66-acre park just north of the Gooding city limits along the Union Pacific Railroad mainline, but was not among the successful Magic Valley applicants announced last week.

A companion \$435,000 federal Economic Development Administration grant is still being considered but is "in limbo," Gooding Mayor Gene Heller said Monday.

The EDA grant requires matching funds, so the city would have to come up with funds similar to the amount of the block grant before it could become effective.

"We just don't know how things will go right now," Heller said. He said the industrial park will remain on the drawing board unless the

state decides to locate its new maximum-security prison at the site of the old state tuberculosis hospital or someone reopens the long idle Blincoe's Magic Valley meat packing plant.

"Something else has got to happen before much will happen with the park," he said.

The park plans had called for installation of a 1 million gallon water storage tank at a site within the city limits and extension of water and sewer service to the park as well as development of an access road and railroad siding.

Arkosh Brothers Inc. of Gooding had indicated an interest in developing a potato processing plant in the park, and Universal Smog Eater Muffler Company, another Gooding firm, was expected to be a park tenant.

Heller said the city still needs the 1 million gallon water tank for improved water service and adequate fire protection.

He said the city council feels the grants that were awarded last week

• See PARK on Page B2

Hospital transfer entails legal maze

By JANE ROBISON
Times-News writer

GOODING — The problems facing Gooding County in transferring over transfer to a taxing district are not insurmountable, say officials who have gone through the experience. At a meeting this week, Gooding County Prosecutor Lynn Nelson told the Gooding County Board of Commissioners that state law does not provide for the transfer of county-owned property to another political subdivision.

However, hospital officials and lawyers for hospitals throughout Idaho said on Thursday that such a law does exist and four hospitals in the state have formed hospital districts with no problems.

The four are Valley County Hospital in Cascade, McCall Memorial Hospital in McCall, Kootenai Medical Center in Coeur D'Alene and Council Community Hospital in Council.

Nelson on Thursday refused to comment on the progress or lack of progress in ironing out the transfer of the county-owned hospital to a newly created hospital district.

"Some of the problems are too complicated, and we're negotiating with other attorneys," he said. Hospital officials cited Idaho Code

67-2322, which does allow for the transfer of a government entity to another government entity, with or without payment. Nelson did say that he was familiar with that section of the code.

Gooding County voters approved the hospital district on May 27 by a 750-vote margin.

In April, a month prior to the vote, commissioners in Fowers County who held a similar election in April cautioned Gooding County officials to go slowly. Power County Commissioner Lois Bauer said technicalities and timing problems between the fiscal year and the taxing year were causing unexpected problems in getting money to the new hospital taxing district.

Gooding County Commissioner Robert Thackeray said commissioners were aware of possible problems, but they felt they needed to hold the election May 27 anyway, to coincide with the primary election and save the county money.

When asked why the county did not wait and hold an election in November, along with the general election, Thackeray said, "We didn't think we could wait four more months. We needed to know now whether voters would approve this."

But Gooding officials are finding

• See HOSPITAL on Page B2

Twin Falls girl reigns as Miss Idaho

By CLAUDE CHAMBERLAIN
Times-News intern

BOISE — Increased confidence and better communication skills made her second bid for the Miss Idaho title a success, says Jennifer Hovey.

A Twin Falls resident, Hovey was crowned Miss Idaho June 14 during competition at the Morrison Center for the Performing Arts in Boise. Her next step is preparation for the Miss America pageant in September at Atlantic City, N.J.

Last year she represented the city of Twin Falls, but was not chosen as a finalist. This year she represented the Idaho National Guard, after winning that pageant two months ago.

"I just decided to pull my stuff back together and go for it again," she says.

For the talent competition, Hovey played a Hungarian gypsy dance on the violin, an instrument she has played for 11 years. The piece was entitled "Csardas."

An area of the competition that Hovey says held her back last year was the interview. After building her communication skills by working with other pageant winners around the state, she felt she was ready for this year's pageant.

Hovey, also a pageant, was easier because she had built up more confidence than the year before. "I was confident, but I didn't know for sure that I would win. I didn't want to have false hopes that would be shot down," she says.



Jennifer Hovey, 11-year veteran of the violin, played Hungarian gypsy music in the competition

As Miss Idaho, Hovey will receive a \$1,500 college scholarship, a black milk jacket, a car, and many other prizes. She is a junior at Boise State University, majoring in broadcasting.

The daughter of Larry and Jean Hovey of Twin Falls, she is living with the chaperone family of Lloyd and Karen Falk in Boise for the remainder of her reign as Miss Idaho. The purpose of a chaperone family is to remain in close contact with pageant organizers. She will be preparing for the Miss America pageant during the next few months.

Preparation includes attending a

mock interview each week to further improve her communication skills. Hovey says she will be making around 50 state-wide appearances between now and the pageant. Other plans for her near future include purchasing a new wardrobe.

Hovey says she is looking forward to the pageant in September and sees it as a challenge. "No Miss Idaho has ever won the title of Miss America. No one has even come into the top 10. It will be hard to do well, but that makes it all the more fun," she says.

If she wins the Miss America pageant, Hovey will remain in Atlantic City and represent the country throughout the year. Otherwise, she will return to her home town and continue to make appearances as Miss Idaho.

Among the 14 girls Hovey competes with, other winners were first runner-up Christie Cook of Idaho Falls, second runner-up Valencia Bilyeu of Pocatello, third runner-up Mary Arakelian of Nampa, and fourth runner-up Kendra Ruwe of Meridian.

Other finalists were Michelle Hymas, Miss Northside Magic Valley, and Allison Page, Miss Boise. A special judges' award was given to Becky Orr, Miss Upper Valley.

Briefly

Right-to-work foes will meet
 TWIN FALLS — Opponents of the right-to-work law will meet at 10 a.m. Saturday at the City Park in Twin Falls.
 Those who come are asked to bring a sack lunch. Chips and soft drinks will be provided.
 The group will distribute literature to homes in the city of Twin Falls and will meet at 12:30 p.m., after distributing the information, for a picnic and get-together.
 For more information, call 733-8097 or 734-8536.
 People in Jerome County have scheduled this same event and more information is available by calling 324-3237.

Teen-agers hurt in rollover
 TWIN FALLS — Two teen-agers were injured in a single-car rollover early Thursday morning on Addison Avenue East.
 Idaho State police said a car driven by Cassandra Hempleman, 16, of Twin Falls, left the highway near the D&B Supply Co. building, 1 1/2 miles east of Twin Falls, at 12:42 a.m.
 State Police and Twin Falls County officers investigated. Reports showed a passenger in the Hempleman vehicle, Bryan Banas, 17, also of Twin Falls, was pinned in the 1980 sedan and had to be extricated by officers and ambulance personnel.
 Magie Valley Regional Medical Center nursing personnel reported Hempleman was in fair condition Thursday and Banas was serious.

Two injured still hospitalized
 BURL — Two persons who were injured Tuesday night in a motorcycle accident at Ring Corner, northwest of Buhl on U.S. Highway 39, remained hospitalized Thursday.
 Twin Falls County sheriff's officers said Joseph Herring, 35, and Carleen Pierce, 26, both of Twin Falls, were taken to Magie Valley Regional Medical Center by ambulance. Herring was listed as satisfactory Thursday at Magie Valley and Pierce, who was transferred Tuesday night to St. Alphonsus Regional Medical Center in Boise, was listed as serious.
 Sheriff's officers said Herring was driving the motorcycle and Pierce was a passenger. The vehicle started into a curve and went out of control, skidding 31 feet and colliding with a stop sign. Officers said the driver was thrown off when the vehicle struck the sign and slid along the ground for 75 feet. The cycle continued another 36 feet before the passenger was thrown off.

Pizza burglary losses reported
 BURLY — Police in Burley said losses listed to date in a burglary of Al's Pizza at 2501 Overland Ave. are at least \$2,400.
 The business was entered during the past weekend when someone cut a hole around an air vent on the roof and then broke through the ceiling and dropped to the main floor.
 Officers said no arrests have been made. The owner, Al Hunt, told police that about \$400 was missing in cash from a change machine and an undetermined amount was also missing from video games, pool table machines, music and cigarette machines. Most of the game machines had just been emptied. Hunt said, or his loss would have been greater. A video cassette recorder and camera, valued at \$2,000, were also missing.
 Officers said they are continuing the investigation.

LDS preparedness test slated
 TWIN FALLS — An emergency response test will be called Saturday by the Twin Falls Stake of the LDS Church to test preparedness in case of an emergency situation.
 Church officials will be working with the Twin Falls City police department and Twin Falls County sheriff's office in conducting the test.
 During the test, residents will determine where they would go in the event of evacuation from their home and check for adequate provisions and food storage.
 The church officials are urging members to prepare a 72-hour kit of necessary emergency provisions.

Mail, radar thefts investigated
 TWIN FALLS — Thefts under investigation by Twin Falls police Thursday included loss of mail and a missing radar and radar detector.
 William Slout of Twin Falls reported someone entered his car and took a small radar detector from the visor. He said it was valued at \$300. The vehicle was entered while parked in front of his home at 1140 Monroe St., between 10 p.m. Tuesday and 7:30 a.m. Wednesday.
 Edward S. Rovels of 436 2nd Ave. E. told police someone had taken mail from his mailbox, including a new bank card to which \$140 in cash was charged. He said the mail theft occurred sometime prior to Wednesday.

Cattlemen, forest officials face off over roaming cattle

STANLEY (AP) — A recent confrontation between four Stanley Basin Cattle Association grazing permit holders and officials of the Sawtooth National Recreation Area has left the cattlemen feeling "harmed" and U.S. Forest Service officials feeling "misunderstood."
 The confrontation came from a long-standing problem with permit holders' cattle wandering onto private land in the Stanley area, particularly in the towns of Upper and Lower Stanley.
 Also in dispute is the future of a log fence along State Highway 21, west of Stanley, which the Forest Service would like to remove because of the cost to repair and maintain.
 However, forest officials are reluctant to remove the fence unless some other way is found to keep cattle off the highway. The cattlemen say they will not accept responsibility for maintaining or replacing the fence because they don't want to incur liability for it.
 The standoff boiled into a confrontation May 16 when permit holder Mark Stark, Challis, went to the ranger district office in Stanley to sign his permit so he could turn his cattle out the following week. At that time Stark said he discovered new clauses had been written into the permit agreement.
 One clause to which he objected stated that permit holders were responsible for "improvement, maintenance, and replacement" of a 4-mile of fence along Valley Creek between the forest boundary and adjacent private land. Two others requested the permit holders to be "good neighbors and assist as deemed necessary" along another 25 miles of private fence between the national forest and privately owned land.
 Because Idaho open-range law places the burden of fencing out livestock on land owners, rather than livestock owners, Stark said he and the other permit holders regarded the clauses as an unwarranted and dangerous precedent in range management, as well as a potential financial burden.
 "If something like that goes through, we'll all be out of business," Stark said. "We can't afford to fence all the pasture land in the Stanley Basin."
 Stark refused to sign the permit as written and said he was told at first that if he did not, he wouldn't be able to turn out his cattle. However, an official relented when Stark said he would call in a lawyer, he said.
 Al Ashton, superintendent of the SNRA, says the whole incident was an "unfortunate misunderstanding."
 "The permit was not the proper place to deal with this issue at this time, because there is a great deal of discussion that needs to take place first," Ashton said.
 "The clause was offered simply to see if something couldn't be worked out between the cattlemen and the private land owners, but was received as if all the effort was to be on the part of the permittee," he said.
 Ashton said the clauses were inserted into the term permit agreements by the range conservationist, but that he authorized their removal as soon as he heard about them, because there had not been enough discussion on the subject.
 "I am deeply concerned about this misunderstanding," Ashton said. "It's a real unfortunate situation and it was never intended to be entirely their responsibility."
 Despite the fact that the clauses were stricken from the agreements, the cattlemen — Stark, Tom Chivers, Ron Wilson and Calvin Helm — say they are upset by the way the Forest Service handled the matter.
 They said they wonder whether or not the Forest Service was trying to pressure them into signing the permits without close inspection.
 "They waited until one week before we were supposed to turn our cattle out, and we hadn't even gotten our allotment billing yet," said Wilson.
 Typically, permit holders receive their billing a month in advance of their turnout date, so it can be signed and the money sent in before they are mailed their permit for signing, Wilson said.
 "I feel like the delay was pre-arranged," Wilson said. "They were harassing the troops is what it was."

Obituaries

Lloyd Earl Brewer
 ARCO — Lloyd Earl Brewer, 61, of Arco, and formerly of Castledorf, died of Acute Myocardial Infarction at Arco Regional Hospital in Arco of a heart condition.
 Born April 10, 1925, in Williams, Calif., he attended school in California and Idaho. He was in the Navy from 1942 to 1946, then resided in Castledorf, where he worked as a carpenter. On March 16, 1949, he married Betty Coppenbarger in Elko. They moved to Arco in 1950 and were later divorced. He was engaged in the construction business with his father-in-law, Fred Coppenbarger, until the INEL. He was married to Betty June 1, 1966, in Elko, and they resided in Arco. He retired in 1979 due to ill health.
 Mr. Brewer was a past commander of the American Legion, and for many years was secretary-treasurer of Lost River Bowling Association.
 Surviving are: his wife of Arco; three sons, Dwight and Bryce Brewer, both of Arco, and David Brewer of Twin Falls; two stepsons, Jack and Dan Bates, both of Arco; two daughters, Nancy and Pooletto and Shirley McDowell of Dallas; a stepdaughter, Teresa Thatcher of Idaho Falls; a brother, Kenneth Brewer of Arco; two sisters, Virginia Ball of Boulder City, Nev., and Janice Silegemmer of Buhl; 12 grandchildren; and two great-grandchildren.
 The funeral will be held Saturday at 2 p.m. in the Marvel Memorial Chapel in Arco. Burial will be in Hillcrest Cemetery in Arco.

George Allen Nagengast
 RUPERT — George Allen Nagengast, 43, of Rupert, died Sunday morning in Mindoka Memorial Hospital.
 Born Feb. 19, 1943, in Perth Amboy, N.J., he attended schools in New Jersey and served in the Air Force, stationed in Italy. He moved to Boise in 1970, and married Bonnie Dudley in Boise. They were divorced in 1974.
 Surviving are: his wife of Arco; three sons, Dwight and Bryce Brewer, both of Arco, and David Brewer of Twin Falls; two stepsons, Jack and Dan Bates, both of Arco; two daughters, Nancy and Pooletto and Shirley McDowell of Dallas; a stepdaughter, Teresa Thatcher of Idaho Falls; a brother, Kenneth Brewer of Arco; two sisters, Virginia Ball of Boulder City, Nev., and Janice Silegemmer of Buhl; 12 grandchildren; and two great-grandchildren.
 The funeral will be held Saturday at 2 p.m. in the Marvel Memorial Chapel in Arco. Burial will be in Hillcrest Cemetery in Arco.

George Allen Nagengast
 RUPERT — George Allen Nagengast, 43, of Rupert, died Sunday morning in Mindoka Memorial Hospital.
 Born Feb. 19, 1943, in Perth Amboy, N.J., he attended schools in New Jersey and served in the Air Force, stationed in Italy. He moved to Boise in 1970, and married Bonnie Dudley in Boise. They were divorced in 1974.
 Surviving are: his wife of Arco; three sons, Dwight and Bryce Brewer, both of Arco, and David Brewer of Twin Falls; two stepsons, Jack and Dan Bates, both of Arco; two daughters, Nancy and Pooletto and Shirley McDowell of Dallas; a stepdaughter, Teresa Thatcher of Idaho Falls; a brother, Kenneth Brewer of Arco; two sisters, Virginia Ball of Boulder City, Nev., and Janice Silegemmer of Buhl; 12 grandchildren; and two great-grandchildren.
 The funeral will be held Saturday at 2 p.m. in the Marvel Memorial Chapel in Arco. Burial will be in Hillcrest Cemetery in Arco.

BURLEY — A memorial service for Robert Metts, 69, of Burley, who died Tuesday, will be conducted at 11 a.m. Saturday at Burley's Chapel in Burley. Inurnment will be in Pleasant View Cemetery. Friends may call at McCulloch's prior to the time of the service.

TWIN FALLS — A graveside service for James Hayes Heck Jr., 54, of Twin Falls, who died Monday, will be conducted at 11 a.m. Saturday in Twin Falls Cemetery. Friends may call at the White Mortuary Chapel today from 10 to 11 a.m.

MAGIC VALLEY REGIONAL MEDICAL CENTER
 Admitted
 Mrs. Cory Flynn, Marilyn Lakey, Henry Case and Jared Rubbel, all of Twin Falls; Ludwig Dieters of Ft. St. Lope; Lope Hernandez of Hazelton; and Sharlette Aalba of Jalexip.
 Released
 Todd Wolf of Gooding; Randy Stevenson and son of Shoshone, Mrs. Douglas Stanger of Murtaugh; Mrs. Harold Sargent of Kimberly; Mrs. Alton Mothershead of Hansen; Stanley McKinley of Twin Falls; Jared Barnes of Rupert; and Mrs. Ralph Baisch of Hazelton.
 Births
 Sons to Mr. and Mrs. Cory Flynn and Mr. and Mrs. John

Wash. He was preceded in death by four brothers and a sister.
 The funeral will be held Saturday at 11:30 a.m. in the Immanuel Lutheran Church in Burley, with the Rev. Arthur J. Crosser officiating. Burial will be in Sunset Memorial Park.
 Friends may call at White Mortuary today from 9 to 11 a.m.
 The family suggests memorial contributions to the Lutheran Layman's League or the American Heart Association.

Merlin W. Knip
 RUPERT — Merlin W. Knip, 62, of Rupert, died Thursday at Mindoka Memorial Hospital.
 A funeral will be held Monday at 11 a.m. in Trinity Lutheran Church, with Pastor J.G. Metzner officiating. Burial will be in Paul Cemetery, under direction of Hansen Mortuary of Rupert.

Oma Garrison
 TWIN FALLS — Oma Garrison, 77, of Twin Falls, died Thursday morning at his home after a long illness.
 The service arrangements are pending and will be announced by the Reynolds Funeral Chapel in Twin Falls.

Harvey M. Cook
 TWIN FALLS — Harvey M. Cook, 61, of Twin Falls, died Thursday morning at 2 p.m. in the Jerome First Baptist Church. The funeral will be held Monday at 10 a.m. in the Twin Falls LDS Stake Center on Maurice Street North.
 A full obituary will appear in Saturday's Times-News.

Nola Shropshire
 FILER — Nola Shropshire, 85, of Filer, died Thursday at St. Alphonsus Regional Medical Center in Boise.
 The funeral arrangements are pending and will be announced by White Mortuary in Twin Falls.

JEROME — Walter Henry Lierman, 77, of Jerome, died Thursday morning at St. Benedict's Long Term Care Unit in Jerome.
 Born Sept. 3, 1908, in Friedensburg, Neb., he moved with his parents to Clover in his early childhood, then moved to California during the early '30s. He married Clara Hellman in Friedensburg, Calif., March 18, 1935. He worked in defense during World War II and served in the National Guard. He had lived in Magic Valley most of his life and had farmed the area since 1955. He had lived in Jerome the past 16 years.
 Mr. Lierman was a member of the Immanuel Lutheran Church.
 Surviving are: his wife of Jerome; a son, Walter Kent Lierman of Tempe, Ariz.; two daughters, Patricia Venzke of Vienna, Va., and Nancy Trueman of Dallas, Texas; six grandchildren; and two sisters, Ida Werner of Santa Ana, Calif., and Ruth Mitchell of Olympia, Wash.

BURLEY — The funeral for Mary Louise "Joey" Hanzel, 76, of Burley, who died Tuesday, will be conducted at 2 p.m. Saturday at the First Presbyterian Church in Burley. Burial will be in Pleasant View Cemetery. Friends may call at McCulloch's Funeral Home today from 2 to 8:30 p.m. and Saturday from 1 to 1:45 p.m. There will be no viewing at the church. The family suggests memorial contributions to the Idaho Youth Ranch.

OAKLEY — A funeral for Ivey Strawn, 52, of Cedar City, Utah, and formerly of Oakley, will be held Monday, will be held Saturday at 10 a.m. in the Joseph Payne Memorial Chapel in Burley. Burial will be in Marion Cemetery. Friends may call at the Payne Chapel today from 4 to 6 p.m., and one hour prior to the time of the service on Saturday.
JEROME — A memorial service for Ernest "Eric" Gupe, 71, of Jerome, who died Monday, will be held today at 2 p.m. in the Jerome First Baptist Church. The service and cremation are under direction of the Howe-Hobertson Funeral Chapel in Jerome.

TWIN FALLS — A graveside service for Opal I. Burrows, 76, of Gridelity, Calif., and formerly of Twin Falls, who died Monday, will be held today at 3:30 p.m. in Sunset Memorial Park. Friends may call at White Mortuary in Twin Falls today from 9 a.m. until 3 p.m.
GOODING — A graveside service for Mary Cavender, 90, of Sunnyside, Calif., and formerly of Gooding, who died Tuesday, will be held Monday at 11 a.m. in Ethnowood Cemetery at Gooding. Friends may call at Demaray's Gooding Chapel Sunday from 1 to 7 p.m.
CASSIA MEMORIAL
 Admitted
 Glenda Hanks, Alna Blankenship and Emory Osterhout, all of Burley; and Janne Rivers of Rupert.
 Released
 Fred Darrington, Christine New, Albert Gander and Elaine Olson, all of Burley; Loretta Holmes and baby of Paul; Elsie Allen and baby of DeLo; Shari Belt of Albion; Mary Bair of Heyburn; Hikki Maier and Sandy Johnson and baby, all of Rupert.
 Birth
 A baby to Mr. and Mrs. Ken Rivers of Rupert.

Holstein sales tallied

TWIN FALLS — Parker Vallant Jerry, a yearling heifer, was the highest-selling animal at the Idaho State Holstein Association's Gorm of a Summer Sale at the Twin Falls County Fairgrounds June 13.
 Stouder Holsteins of Wendell paid \$3,600 for the heifer, owned by Blair Parker & Sons of St. Anthony.
 The second highest-selling animal was a first calf heifer, Smutny Star Wars Truce, owned by Alvin and Joanne Smutny of Twin Falls. Stan Grozz and Ken Melvold of Fresno, Calif., bought the calf for \$1,800.

RESULTS!
 The classified way. A Times-News classified will sell, buy or rent any item!
Phone 733-0626

ALWAYS READY TO SERVE

WHITE Mortuary
 "The Chapel by the Park"
 136 4th Ave. East - TWIN FALLS
 PHONE 733-6500
 NATIONALLY SELECTED INVESTIGATORS

Hospital

Continued from Page B1
 out now that it may take four months or more to draw up the papers and negotiate a transfer of Gooding Hospital to the county to the new hospital district.
 Rich Holm, an assistant administrator for McCall and Valley hospitals, said that even though voters in Valley County approved a hospital district in a December 1984

vote, ownership was not transferred until April 1985.
 Holm also said that both hospitals knew in advance that tax money from the new district would not come in until the following year, and they set aside operating money to cover the budget until then.

Park

Continued from Page B1
 were necessary. "The board (awarding grants) did a good job," he said and pointed to Wendell's serious need for a sewer plant improvement.
 The city of Wendell was one of five Magie Valley communities awarded a grant.
 "They really need the plant," he said. "We could not compete with that."
 Gooding has received two similar grants in the past, but because the proposed projects were not developed, grant approval was withdrawn.
 A grant awarded in 1977 was for improvement at the site of a proposed woman's prison, but the EDA grant was withdrawn when the state built the facility in northern Idaho because of heavy opposition to the project in the Gooding area.
 In 1985, a \$720,000 state grant was allotted for prison development at the old TB hospital site but was withdrawn when the developer of the private prison, Buckingham Security Ltd. of Pennsylvania, was unable to get financial backing for the proposed regional facility.

Magie Valley Regional Medical Center
CHAPEL DEDICATION
 COMMUNITY INVITED
 Sunday, June 22, 1986
 Open House 3:00-5:00 p.m.
 Formal Dedication At 4:00 p.m.
 Refreshments Served
 The MVRMC Chapel was funded by the Medical Center Foundation

Room

Continued from Page B1
 The interviewers will use toys such as the dolls, doll houses and art supplies to help the child tell about incident of abuse.
 Chilcse said there still is a need for children's furniture, paint and money to purchase two sets of anatomically correct dolls. There are four dolls to a set, costing \$150 each.
 Members-of-the-Child Protection Team, a group of volunteers helping young victims of abuse, will paint the room, she added.
 Baxter plans to begin using the room by Aug. 1.

COLORCRAFT FAST FILM DEVELOPING
 Quality Photofinishing
FREE REPLACEMENT FILM
 24 EXPOSURE COLOR FILM
 Sizes 126-110-135-Disc with every roll of color film developed and printed Guaranteed Service and Quality
PLUS 11th Roll FREE!
 Processing
 Every time you have your film processed we record it and your eleventh (11th) roll will be processed at no charge.
PLUS FREE 'Write-On'
 VINYL ACETATE ALBUM PAGE TO PROTECT YOUR FAVORITE PRINTS
 NEXT DAY SERVICE
COLORCRAFT
 1869 E. Addison - Twin Falls, Idaho
 Open 8:00 a.m. to 5:00 p.m. Mon-Fri.

Hospitals

MAGIC VALLEY REGIONAL MEDICAL CENTER
 Admitted
 Mrs. Cory Flynn, Marilyn Lakey, Henry Case and Jared Rubbel, all of Twin Falls; Ludwig Dieters of Ft. St. Lope; Lope Hernandez of Hazelton; and Sharlette Aalba of Jalexip.
 Released
 Todd Wolf of Gooding; Randy Stevenson and son of Shoshone, Mrs. Douglas Stanger of Murtaugh; Mrs. Harold Sargent of Kimberly; Mrs. Alton Mothershead of Hansen; Stanley McKinley of Twin Falls; Jared Barnes of Rupert; and Mrs. Ralph Baisch of Hazelton.
 Births
 Sons to Mr. and Mrs. Cory Flynn and Mr. and Mrs. John

Cash is smart wedding gift, says reader

DEAR ABBY: I hope you print this real soon so we can get the response from other people. I know you probably won't agree with me, but I am being realistic.

It's June, the time for wedding gifts. I think it is a very good estimate that about half of the gifts will never be used.

I have decided that unless I know what a couple needs, I am going to send money. It may be only \$5, but it can be put toward something the newlyweds need and will use.

I will never send another gift out of town because it usually doesn't get there on time, and it is too much trouble to wrap and mail.

A card with a check in it is much easier, and will be appreciated just as much — maybe more. This may sound like a tacky idea to some people, but most couples I've talked to agree with me.

So, Abby, tell your readers if they want to give a gift that will be definitely used, to send money.

DEAR SMART: Much would depend upon the circumstances of the giver and the recipients. Common sense should be the key. To give a struggling young couple who are trying to make ends meet a sterling silver pickle fork seems thoughtless to me. But to assume that all young couples are devoid of sentiment and prefer cash is presumptuous.

Moreover, it's the privilege of the givers to give whatever they wish. Some are more comfortable buying a \$10 gift that looks like \$25 than sending the couple \$10.

DEAR ABBY: While sorting the laundry this morning, I noticed a bright red spot on my husband's underwear, so I looked at it really good and found that it was a fake fingernail clinging to his shorts. It



Abigail VanBuren
Dear Abby

was one of those press-on fingernails. I don't use them.

Can you think of any situation where he could be innocent?

— HIS WIFE, RAYTOWN, MO.
DEAR WIFE: The finger points to a brief encounter. Now that you've nailed him with the evidence, tell

Hubby why you're seeing red.

DEAR ABBY: I have a very fine son who is married to a lovely girl. For 15 years she called me nothing. When she addressed me, she merely looked at me and made her statement. About a month ago, she started calling me "Shirley" — my given name.

I am not comfortable with this kind of familiarity. I am her mother-in-law — not her girlfriend. Though I care for her deeply, I feel a brief encounter. Now that you've nailed her with the evidence, tell when she calls me Shirley. I do not

like it. I never really liked it when she called me nothing, but I like it even less now that she's calling me Shirley. I prefer that she go back to calling me nothing.

I must tell her before it gets to be a habit she can't break, as it is rubbing me the wrong way. Would I be wrong to tell her?

— CALL ME NOTHING
DEAR CALL ME: You would be wrong not to tell her. But tell her soon — and in a friendly, non-critical way. It will require some gumption on your part, but it beats being rubbed the wrong way.

GRANNIE'S
SALE! SALE! SALE!

Baby Quilts - \$15 and Up
1240 Blue Lakes N. & P.
(Next to Blue Lakes Sporting Goods)

HOURS: Mon.-Thurs. 10 A.M.-7:30 P.M.
Friday 10 A.M.-9:00 P.M.
Saturday 10 A.M.-8:00 P.M.
734-5756

Save 20%

precious fiber coats: cashmere, cashmere blends, camelhair, marino wools. Idaho's biggest selection!



trunk showing

MONDAY THRU SATURDAY

Lavish. Exquisite. That just begins to describe the glorious gathering of precious fiber coats we'll have displayed this week at The Paris. A manager and associate from Fleurette of California and Manchester editions will be present with the entire line of coats for fall and winter '86-'87.

Classic camel hair boycoats. Double breasted, deep patch pockets and back belt in mid-call lengths. 100% camel hair. 4-16. Regularly 399.00, now \$322.

Wrap coat in luxurious Amicalo cashmere from Manchester Editions. Mid-call length with convertible collar, dropped arm holes. So much more than just a wrap. Regularly 569.00, now \$462.

100% cashmere. 52" three button single breasted coat. Easy shoulder, deep welted pockets. Choice of colors. Regularly 572.00, now \$476.

A SAMPLING OF OTHER SELECTIONS:

| | |
|-----------------------|-------|
| Regularly 366.00, now | \$292 |
| Regularly 462.00, now | \$369 |
| Regularly 312.00, now | \$249 |

WE WELCOME SPECIAL ORDERS AND LAYAWAYS

The Paris

Grandma works job, moves on

CHEYENNE, Wyo. (AP) — A retired medical records transcriptionist and grandmother of five is traveling across the country, staying on a job just one day in every state.

Barbara Morgan of Walnut Creek, Calif., plans to write down her experiences in a book she wants to call, "Grandma Phone Home."

During her six month tour, her experiences will include work: as a ranch hand doing some cattle roping in Wyoming; a sulky driver in Kentucky, plucking chickens in Maryland; lobster trapping in Maine; on the Miss America pageant in Illinois; as a policewoman in Michigan; a disc jockey in New Jersey; a coal miner in Virginia; a riverboat captain in Mississippi and a peanut inspector at a peanut butter factory in Washington.

The 59-year-old was in Wyoming recently and addressed a number of senior citizens at the state capital, telling them she wanted to add some adventure to her life. She urged them to do the same.

"When you live in one little corner of the United States, you have a convoluted view of the world," Morgan said.

She said she began planning her trip four years ago but no one took her seriously. Morgan wanted to travel by motor home but decided to travel by public transportation.

She said she "prepared" cities for her arrival by writing the chambers of commerce. Morgan will only work in small cities because larger cities are "too sophisticated" and not what she had in mind for her book.

"I ask them if they would select a job for me, a one-day unpaid internship that would best describe the grace, style and lifestyle of their city," Morgan said.

Her visit to Cheyenne was her fifth stop and she added that she's already had more adventure in three weeks than she's had in her entire life.

A memorable experience was in Riggins, Idaho at Squaw Creek Retreat, she said. She spent her workday as a "teepee motel maid."

While asleep during an hour-long thunderstorm, she described as the worst she's ever been through, Morgan rolled off a waterbed onto the floor.

According to her schedule, Morgan will work on weekdays and take the weekends off. In the cities where she can stay with friends, she said she plans to stay a little longer than a day.

Class begins on computer

TWIN FALLS — Wordstar Word Processing, a one-credit class, will begin June 23 at the College of Southern Idaho.

The class will provide intensive hands-on training in word processing on the IBM computer. Previous computer experience is recommended. The class will run for five Mondays from 6 to 9 p.m. in Room 144 of the Vo-Tech Building. The fee is \$47.50, and students can preregister in the Taylor Administration Building. For more information, call 733-9554, ext. 364.

Idaho/West

Fatal crash fuels fight over flights above Grand Canyon

By ROBERT MACY
The Associated Press

LAS VEGAS, Nev. — The crash of a plane and helicopter carrying tourists for a close-up view of the Grand Canyon has added new fuel to a fight between environmentalists and airline companies over the safety of the popular flights.

Hikers, river rafters and backpackers have conducted a 2½-year war against the lucrative aerial tour business, saying the noise of planes and helicopters disturbed the sanctity of the canyon.

The issue of safety was seldom raised in recent public hearings aimed at limiting the canyon flights. But it quickly became a major topic Wednesday when a plane and helicopter collided in mid-air 10 miles from scenic Grand Canyon airport, killing all 25 on board.

Meanwhile, an owner of Grand Canyon Airlines, which owned the plane involved, said sightseeing helicopters had changed their flight paths over the canyon in recent weeks in an effort to appease those complaining of aircraft noise.

"I'm not saying that caused the accident," said John Sebald, owner of Las Vegas-based Scenic Airlines and one of the owners of Grand Canyon Airlines. "But there are things going on out there in the interest of sound that may not be in the best interest of safety."

"We've been flying the canyon since 1948 and there has never been a mid-air with the exception of the TWA and United (commercial airlines) 20 years ago. Not until the Wilderness Society and the Sierra Club got involved in a search for solitude did the operators start

altering their routes."

Rob Smith, a spokesman for the Sierra Club in Phoenix, admitted safety is not the main area of concern for environmentalists.

"But the tragedy of the crash underscores that there are too many aircraft in the Grand Canyon with too few regulations."

Some 40 companies in five states operate an estimated 50,000 flights a year into the canyon, with three-fourths of the flights originating in Las Vegas. Some 400,000 people saw the canyon by air last year, pumping an estimated \$70 million into the tour flight industry.

The number of flights is expected to more than double by the year 2003 and some officials fear the park overflight problem is not limited to the Grand Canyon.

"I can't see how Interior Department officials can say that there is not a problem with tourist flights over our national parks," Rep. Richard Lehman, D-Calif., said after learning of Wednesday's crash.

Lehman, a member of the House Interior and Insular Affairs Committee, said the days of self-regulation by the air carriers is over.

"This is going to play right into their hands," Donald Donohue Jr., director of the National Park Service, said of the controversy between the air carriers and the environmentalists. Donohue is managing director for Las Vegas Airlines in Las Vegas.

The National Park Service has submitted six alternatives for consideration in dealing with the growing number of flights and the concerns of environmentalists.

One would call for no action at all. Another would limit flights to 2,000

feet above the rim and a third would restrict flights in the inner gorge and some other flight-free areas. A fourth would limit flights within 1,500 feet of landforms and a fifth would restrict flights below the rim and in some flight-free areas. A sixth alternative would limit flights to 2,000 feet above the rim and set flight-free areas.

Richard Marks, superintendent of the Grand Canyon National Park, said Thursday the area where Wednesday's crash occurred would have been off limits under one of the six alternatives.

Marks said military aircraft are also a problem because they fly faster "and have less response time."

Environmental groups want all flights restricted to 18,000 feet above the canyon rim — an altitude most tour planes cannot reach.

The flight operators have an understanding with the Federal Aviation Administration they will not fly less than 2,000 feet above the rim. But there is no legal rule and the limit is widely ignored. Most flights dip below the canyon rim at many points along the tour.

Charles Farrabe, management assistant for the park, said the FAA is the agency responsible for aircraft operations in and over the canyon.

"Our concern basically is environmental and noise," Farrabe said Thursday.

"This kind of accident was almost waiting to happen," said Bob Heston, the Sierra Club's Southern California representative. "When Congress created the National Park Service, it wanted to protect the natural quiet and protect visitor safety. Those airplane flights violate



Twin Otter wreckage is scattered across mesa in Grand Canyon following crash Wednesday

both of those things." James Kahana, executive vice president of the Grand Canyon Helicopters, said flying over the canyon is "remarkably safe" despite the crashes.

"There is less air traffic over the canyon than in holding patterns over major airports such as those in Los Angeles, New York or Chicago," Kahana said.

"I hope the powers that be will realize that this is a fluke accident and not let all the studies and hearings go down the drain," Kahana added.

Tour aircraft fly through the canyon on a "see and be seen" basis and are not controlled by radar.

Sightseers' safety has long been major question

GRAND CANYON VILLAGE, Ariz. (AP) — Hearings that dealt with noise reduction issues already had raised questions as to air safety over Grand Canyon National Park before Wednesday's collision that claimed 25 lives.

Some opponents of flight in and over the canyon were raising those questions again after the collision of a helicopter and a twin-engine plane.

Others argued the flying space over the canyon was safer than airspace over some of the nation's major airports.

Superintendent Dick Marks said Wednesday that "there isn't anything that happened that

happened today that affects what we've already heard on the subject."

The National Park Service has been conducting hearings as to the future of scenic canyon flights. The six alternatives under consideration range from unrestricted flight to barring flight less than 2,000 feet above the canyon rim — the same restriction embodied in the Federal Aviation Agency's current advisory. That advisory carries no enforcement provision.

Authorities said the crash site is about 4,000 feet below the rim but that the altitude at which the aircraft were flying wasn't known.

The site — a stark, barren hillside

three miles north of the Colorado River and about 10 miles west of the park's visitor center — is within the portion of the canyon known as the Inner Gorge.

The Inner Gorge has been identified by the federal Office of Aircraft Safety as a "hazardous flying environment" according to an environmental assessment issued by the park this year in connection with noise reduction proposals.

The assessment also said the aircraft safety office described the upper airspace of the canyon as an area of concern with the potential for collisions.

Wednesday's collision occurred only 12 days short of the 30th anniversary of the worst crash in the canyon's history, the June 29, 1956, collision of two commercial aircraft in which all 128 people aboard were killed.

In the past five years, according to the park assessment, there have been 10 aircraft crashes within the park resulting in 17 deaths. Fifteen deaths resulted from three crashes within 10 miles of the park's boundary, it said.

The aircraft safety agency suggested better controls in the unique Grand Canyon flying environment. It proposed better use of advisory radio messages to pilots in the area, designation of "special-use airspace" in the Inner Gorge and an "Alert Area" for the remainder

of the park's airspace.

There is no FAA flight control center for the canyon, and aircraft are not tracked by radar, operating instead under visual "see and be seen" rules.

Park officials have estimated that as many as 40 companies conduct 250,000 to 400,000 flights annually over the Grand Canyon. The Arizona Department of Transportation has predicted that under current regulations, Grand Canyon flights will double between now and the year 2,000, a Sierra Club spokesman said.

Environmentalists say safety would be an auxiliary benefit from their proposals that flights within the canyon be barred and that

flights over the canyon be restricted to 2,000 feet above the rim.

There have been other crashes, some of them with fatalities.

★ SAVE WITH THIS COUPON ★

Old Photos Copied & Restored Black and white copy negatives. NOW \$1.00 each

10% OFF on black and white print orders. This coupon good only on new orders and until June 30.

Dudley Studio 1042 Blue Lakes, near Kentucky Fried Chicken

CUSTOM HAIR & CO. Professional Curling Irons. Only \$5.75. Open 8-8 Mon.-Fri. To Accommodate The Working Person. 121 Main Ave. E. 733-0839

Official thinks lake due for cleanup too

COEUR D'ALENE (AP) — The Bunker Hill Superfund cleanup site should be expanded to include the Coeur d'Alene River and at least part of Lake Coeur d'Alene, according to an Interior Department official.

"We believe the (Superfund) site impacts extend far downstream and into the lake," said Chuck Polyska.

Resources under the Interior Department's trusteeship outside the study boundaries, currently at 21 square miles, have been damaged by mining and smelting, Polyska said.

However, the Environmental Protection Agency probably will not agree to that suggestion, a state official said.

"I don't see EPA jumping out and expanding the Superfund site," replied Idaho hazardous materials specialist Brad Harr, one of the Bunker Hill Superfund study team members.

Harr said EPA's chief concern is for known human health problems, such as those existing in Kellogg area children exposed to heavy metal dust from decades of smelter pollution.

The comments came as state and federal officials met for two

days late to follow developments pertaining to accumulation of heavy metals downstream from the now-closed Bunker Hill smelter.

The Consortium for Human and Animal Health received a briefing Tuesday and Wednesday on the heavy metals problem in the river and the lake.

Academic studies of the effects of mining and smelter tailings on the lake and the river go back to 1932. Public concern has risen lately over planned cleanup and over elevated levels of lead and cadmium in lake fish.

The river's South Park, which runs past the smelter, carried from 300 to 400 pounds of lead and 200 pounds of cadmium per day during the early 1970s, according to Evan Horning, an EPA water quality specialist.

Since the smelter's closing in 1981, the river load has dropped to 20 pounds of lead and 13 pounds of cadmium daily, he said.

Lead levels in perch caught from Lake Coeur d'Alene last year were up to 35 times those found in perch caught in Spirit Lake, which is fed from a different watershed, biologists said.

INEL may get SDI research

WASHINGTON (AP) — Members of a House-Senate conference committee have approved the transfer of \$30 million from the Pentagon to the Department of Energy that could be used in "Star Wars" research projects at Idaho National Engineering Laboratory.

Sen. James McClure, R-Idaho, member of the Defense Appropriations Subcommittee and a Senate conferee, said the proposal is included in the supplemental appropriation bill for 1986.

Members of the House and Senate met Tuesday to work out differences in the proposal.

McClure said INEL was host to a conference last week on the Strategic Defense Initiative, known as Star Wars.

WATCH FOR THE SPECIAL CAIN'S ANNIVERSARY INSERT Coming Sunday June 22 in The Times-News

Collett's HOME FURNISHINGS DELIVERS FREE! WE'VE GOT SOME GOOD NEWS FOR YOU! Collett's Home Furnishings now has two conveniently located showrooms to serve you! Whether you're visiting Salt Lake or Ogden, you are going to find that we have the greatest selection of quality home furnishings in the Intermountain area! Collett's offers you the finest in living rooms, bedrooms, dining rooms, recliners, bedding, accessories and much, much more, by the top name manufacturer in the country! GUARANTEED LOWEST PRICES! You'll find that we have the best credit terms available and that we can easily tailor a plan to fit your needs! Collett's has the furniture you want and need at the guaranteed lowest prices! FREE DELIVERY! And to top off all of this, Collett's delivers free within 275 miles! So you see you owe it to yourself to take a good-look at Collett's for top quality home furnishings, guaranteed lowest prices and free delivery! You Owe It To Yourself To Take A Look At Collett's HOME OWNED AND HOME OPERATED *Free delivery within 275 miles. 7200 SO. STATE S.L.C. UTAH 566-1251 3111 WALL AVE. OGDEN, UTAH 621-3036

Sklavos gets first world title match

By RON GATES Times-News writer

Twin Falls' Carl Sklavos, frustrated by the cancellation of a March shot at the United States bantamweight title in full-contact professional karate, will instead bid for the world crown on August 9 in Denver.

"Things have worked out so that Carl will meet Jerry Clark for the world title," announced Sklavos' trainer Gene Starr on Thursday.

The champion sports a record of 29 wins, six losses and three draws while Sklavos remains undefeated in 10 professional bouts.

"Word has it that Clark didn't really want to fight Carl very bad," Starr continued. "He (Clark) wanted a tune up fight first. We figured as many fights as he has under his belt against Carl's 10, it was an unnecessary delaying tactic. So, it's fight or be stripped of the title."

Starr went on to compare styles of the combatants. "Clark is noted for his hard fists and has a fast spinning back kick. We've been watching replays of his fights and picking him apart.

Sklavos has a pretty fair back kick of his own and we're going to beat him at his own game."

The 22-year-old Twin Falls native demonstrated the power of that jump spinning back kick in the fight that originally earned him a U.S. championship bout. In that one, Sklavos employed that tactic to knock previously unbeaten Mark McClellan less than two minutes into the bout.

The sixth-ranked Sklavos was set to meet U.S. champ Everett Berry in a U.S. title fight on March 1 at Cactus Pete's Convention Center in Houston, but that match never materialized.

Claiming an eye injury in a sparring session, Berry withdrew much to the dismay of the challenger and his Denver based manager, Karen Turner.

The card went on with Rudy Lovato of Albuquerque, N.M. subbing for the injured Berry. Sklavos kept his record perfect in registering a six-round unanimous decision over his more experienced adversary.

Turner, through Superbouts, Inc., will again act as promoter as well as manager.

Little loop tourney tops weekend fare

By the Times-News

The eighth annual Twin Falls All-Star Little League Tournament heads a lighter than usual weekend slate of action on Magic Valley diamonds. Opening games are slated for 3 p.m. today at Harmon Park.

A field of 15, playing a round-robin format in A, B and C divisions, will continue all day Saturday beginning at 8:30 a.m. and from 8 a.m. Sunday on through to a 1 p.m. championship conclusion.

Detour Construction Joins Kiwanis, Merchants and the Softball Association in carrying the banner for the host city. Caldwell and Jerome have two representatives each while single squads have been entered from Blackfoot, Burley, Rupert, Gooding, Wendell, Filer and Shoshone.

The softball fields will be quiet in Twin Falls over the weekend, but not so in Rupert and Jerome.

Big Valley Park in Rupert is the site of the inaugural Mini-Cassia Men's Class B Tournament which kicks off with games at 7 p.m. today.

Three teams from the Buhl Softball Association and one from the Idaho State School for the Deaf and Blind in Gooding combine with nine Mini-Cassia contenders in that double elimination tourney.

Second round contests are slated for 8:30 a.m. Saturday and will finish up with an 8:30 tie class.

The field has been reduced to 16 at Jerome for the Men's Class B Invitational, but, if lacking in quantity, the quality of the entrants promises good action. Always tough Mint Bar out of Halley will be there along with Brown Realty from Paul and an unknown entity in Budweiser of Nyssa, Oregon. Twin Falls sends four teams while Jerome Men's B League teams — including last weekend's champion Longview Dairy — round out the field.

The smaller than expected number resulted in a schedule change which will see play open at 8 a.m. Saturday and only a 6:15 p.m. start for the final Sunday resumes at the same hour on Sunday with the wind up set for 5 p.m.

NFL attacks system for compiling USFL's anticipated loss

NEW YORK (AP) — A National Football League attorney Thursday mocked the method an expert witness for the USFL had used to calculate the damages the fledgling league is asking in its \$1.69 billion antitrust suit against the establishment.

Dr. Nina Cornell's projections, attorney Robert Fiske said, could mean the New Jersey Generals of the USFL would be playing to a crowd of 232,000 by 1992.

Cornell, an economist, had prepared two studies to buttress the USFL's damage claims.

Study A projects \$65 million in damages and is based on the old American Football League experience before the 1970 merger. It uses the AFL teams' single network TV revenue, gate receipts and players' salaries as a comparison of what might have happened had the USFL played in the fall instead of the spring for its first three years.

Study B, which asks for \$301 million, is taken from an in-house CBS study which was designed to learn if it was feasible to televise USFL games in the fall and projects three-network coverage.

Both studies ranged from 1983 through 1992 and had no increased cost factors. Ticket prices, revenues and player salaries all were all frozen for '83 and kept constant, with no network contract assumed and only a \$10 million yearly cable commitment.

Cornell said that any outrageous crowds as Fiske had insinuated might be possible, could not happen because she had built in a restraint — the actual sizes or size of the stadiums. But Fiske attacked the methodology.

Cornell's growth potential for the Generals was based on an average between the New York Jets and

Drug tests ordered in death of Bias

COLLEGE PARK, Md. (AP) — Len Bias, who said he was living a "dream within a dream" after being drafted by the National Basketball Association champion Boston Celtics on Tuesday, died unaccountably of an apparent heart attack Thursday.

CBS News and Washington, D.C. television station WJVM quoted unidentified police and hospital

sources as saying that traces of cocaine had been found in the University of Maryland star's urine, but it was undetermined if that was a factor in his death.

Bob Law, a spokesman for the Prince George's County police, said authorities were awaiting results of an autopsy to determine both the exact cause of death "and whether drugs are involved."

The 22-year-old Bias, described as in perfect health, collapsed in his dormitory room just hours after returning from meetings in Boston with Celtics officials who had made him the No. 2 in the NBA draft.

Dr. Edward Wilson, chief of emergency services at Leland Memorial Hospital, where Bias was pronounced dead at 6:50 a.m. EDT, said there was "major damage" to the heart but "we don't know what caused the damage."

Dr. John Smialek, the chief state medical examiner, said his office would not release preliminary findings and estimated a complete report would take several days.

Maryland Athletic Director Dick Dull said the school had performed routine drug tests on Bias and other members of the team and "we've never had absolutely any kind of indication that there was excess of alcohol or any kind of drug involvement by Lenny Bias."

"The tragic end of what appeared to be a career of unlimited promise came just days after Bias passed a physical given by the Celtics."

Boston superstar Larry Bird, who urged the team to select Bias and was to work with Bias at rookie camp, said:

"It's horrible. It's the cruelest thing I ever heard."

Bias, who was attending summer school after playing his final college season, was stricken about 6:30 a.m. EDT.

Hospital spokesman Frank Berry said Bias was brought in about 6:50 a.m. and died two hours later following unsuccessful attempts to save the athlete.

Wilson said he understood a friend tried to revive Bias with cardio-pulmonary resuscitation and the procedure was continued on the 1 1/2-mile ambulance trip to the hospital.

"The heart was stimulated by

chemical and pacemaker means," said Wilson, the attending emergency room physician. "There was no response. The heart was not pumping and the lungs were not working."

"So far as I know, it was a sudden collapse," Wilson said. "There was no chest pain so far as we know. Nothing would indicate something was wrong."

Asked if such a sudden death for someone in apparently robust good health weren't unusual, he replied, "It's unusual, but it does happen."

WJVM said detectives were trying to question two players who were with Bias in the early morning hours. The station said investigators became suspicious because the room where Bias collapsed was spotless and appeared to have been recently cleaned.

Initially, WJVM reported, the two players with Bias told police that he had two or three beers in the 3 1/2 hours before he collapsed but unidentified sources said there was no trace of alcohol in the urine.

Maryland Coach Lefty Driesell, who recruited the extremely agile 6-foot-8 Bias from Northwestern High in nearby Adelphi, Md., and several of Bias' teammates rushed to the emergency room upon hearing the news.

Driesell, who frequently called Bias "All-World" during a senior year when he averaged 23.2 points and 6.8 rebounds a game, said at a late afternoon news conference he thought Bias was "the greatest basketball player that ever played in the Atlantic Coast Conference."

"I've known Leonard since he was in the fifth grade," Driesell said. "He was like a son to me."

"He was a born-again Christian," Driesell said. "He turned his life over to the Lord. He's in a better position now than we are. He is at home with the Lord. I love you Leonard, and I miss you."



Len Bias was called "all world" by his Maryland coach

Bias' death marks third for Terrapins

COLLEGE PARK, Md. (AP) — Len Bias, who died Thursday of a cardiac arrest, became the third University of Maryland basketball player in just over a decade to die of heart failure, either during or shortly after his collegiate career.

Bias, 22, was pronounced dead at 8:50 a.m., some two hours after he suffered a seizure in his dormitory room on the Maryland campus. A draft pick of the Celtics, he had returned from Boston about eight hours earlier.

Owen Brown was also 22 when, a year after leaving the College Park school, he collapsed and died during a pickup game in suburban Virginia on Feb. 4, 1976.

Less than a month later, on April 1, sophomore center Chris Patton died of heart failure during a two-

on-two pickup game on the campus outdoor courts.

Unlike Bias, who was believed to be in perfect health, Brown and Patton both had heart problems. In fact, a doctor had warned Brown, who was detected to have an irregularity in his heart beat, that he could die while playing basketball.

Brown played for the Terrapins anyway, with a doctor and the necessary equipment always nearby. One year after he graduated, slightly out of shape, the La Grange, Ill., native died in a pickup game.

Brown, an honor student who had an enlarged heart and a test had disclosed that he suffered out-of-beat heart rhythms.

Patton, 21, died of a rupture of the aorta, the large vessel that carries blood from the heart. "It had nothing to do with athletics," said Dr. James Frost at the time.

Bias was simply a cardiovascular disease.

The heart problem, currently called Marfan's Syndrome was not yet defined at the time, but it is possible that is what ultimately led to Patton's untimely death.

Common to the three deaths that have devastated the Maryland basketball program in a period of just over 10 years, UM Athletic Director Dick Dull said:

"These are three tragedies that end for the 10-year program. It's tragic that those three young men could not live to realize their goals."

Maryland Sports Information Director Jack Zane called the deaths "a coincidence," adding, "I don't know how Maryland can get a bad reputation from this. An Olympic volleyball player died of heart problems and we take every precaution possible."

Before each season, the Terrapins put their basketball players through a rigorous physical that includes an EKG.

While Bias passed the exam easily last September, 7-foot-2 freshman Christoph Weisheit of Cologne, West Germany, was detected to be suffering from Marfan's Syndrome after he was ruled out from playing for the team or even participating in intramural basketball.

Fehr, Sutton lead at Atlanta

ATLANTA (AP) — Hal Sutton and Rick Fehr each put together bogey-free rounds and gained a share of the first-round lead with 6-under-par 66s in the \$500,000 Georgia-Pacific Atlanta Golf Classic Thursday.

Fehr, a second-year player still looking for his first victory, was in contention to take the lead alone when he went to the 499-yard, par 5 18th, but ended up with a par while most of the other leading scorers had birdies.

The field of 156 attacked the 7,097-yard, par 72 Atlanta Country Club course in ideal weather as over half the field shot par or better. The temperature was in the low 90s and there was no wind.

"I'm surprised somebody didn't shoot lower than 66," said Sutton, a two-time winner this year who is fourth on the money list.

South African Denis Watson was 7-under-par after 12 holes, but lost his bid to lead when he took a double bogey 6 on the 15th and three-putted for bogey on the 17 before getting back a stroke with a birdie on the finishing hole.

Watson was tied at 67 with six other players — Larry Ziegler D.A. Welbring, Andrew Magee, Mark O'Meara, Willie Wood and Scott Hoch.

Australian Greg Norman, this year's leading money winner, had a 71 along with defending Atlanta champion Wayne Lister and Dan Pohl.

Calvin Peete, bothered by a bad knee, had a 76 and immediately withdrew.

"I've gotten into my thinking winning a lot more," he said. "Second and third place doesn't mean much to me."

Sutton played each nine in 33, getting front side birdies from 2 feet at No. 1, 20 feet at No. 6 and 8 feet at No. 9. He two-putted for a birdie on the 11, scored from 5 feet on the 15th and finished with a two-put birdie from 50 feet on the final hole.

"The course is open to some low scores," Fehr said after going 32-34.

Fehr started with a 15-foot birdie putt on the first hole, got two others from 2 feet or less on Nos. 2 and 4 and had from 6-8 feet on the eighth. He got back side birdies on 16 and 17 from 30 feet and 18 feet respectively.

After playing the demanding Open course last week, Fehr said, "Guys come here and see this course and say 'let's get after it.'"

Lewis on track for three-medal try

EUGENE, Ore. (AP) — Carl Lewis, seeking to duplicate the triple he accomplished in 1983, eased through the qualifying in three events Thursday in the USA-Mobil Outdoor Track and Field Championships.

The versatile, 1984 quadruple Olympic gold medalist, won his 100-meter heat in 10.16 seconds, long-jumped 27 feet, 4 1/2 inches in qualifying, and finished second in his 200-meter heat in 20.41. This is the first day of the four-day championships at the University of Oregon's Hayward Field.

Lewis has won a total of seven national titles, including the 100 and long jump from 1981-83, and the 200 in 1983.

No sprinter has won the 100 four times since the national championships began in 1876. But Lewis, the world's top-ranked sprinter for each of the past five years, who surprisingly has lost twice this season, looked sharp in posting the fastest time in the four heats of the 100.

"The race felt easy and relaxed,"

Lewis said. "I've been working on my start and concentrating a bit more. I feel ready to start running well again in this meet."

In the long jump, Lewis qualified on his first try, and in the 200, he was a runner-up behind NCAA champion Floyd Heard of Texas A&M in his heat. Heard was timed in 20.37, with Calvin Smith just behind Lewis in 20.42.

In the 100 qualifying, the heat in which Lewis ran, may have had more Olympic medalists than any heat in history. In addition to Lewis, there were gold medalists Kirk Bristle and Smith, silver medalist Dwayne Evans and bronze medalist Thomas Jefferson.

Baptiste, the defending champion in the 100 and 200, finished just behind Lewis in 10.17, with Smith, the world record holder, third in 10.24.

The other heat winners were Heard in 10.20, and two-time Olympian Harvey Glance and Michael Morris in 10.21 apiece.

Lee McEae, the NCAA 100 champion, also qualified, finishing second behind Heard in 10.26.

In the 200, Baptiste registered the fastest time in the four qualifying heats with a 20:35 clocking, while Evans ran his heat in 20:36 and Wallace Spearman took the other

heat in 20:40.

In the women's 100 qualifying, world record holder Evelyn Ashford, seeking her sixth national title in this event, raced to victory in her heat in a time of 12.52.

"Everything's going good, it's going great," said Ashford, who skipped the 1985 outdoor season after giving birth to a girl. "It felt very easy. I feel like I have a lot more in me -- I want to get it out tomorrow (Friday), in the semifinals and finally. I feel I have more endurance this year, but I'm not sure of my speed. I don't think the layoff helped my speed. I'm a speed runner."

"The other heat winners in the women's 100 were Alice Brown (11.11) and Pam Marshall (11.21). Meanwhile, Diane Dixon set a stadium record in winning her heat in the women's 400 in 51.04. The old mark was 51.05 by Marita Payne."

Brenda Cliette (52.22) and Alice Jackson (52.70) were the other heat winners.

Hoddie Haley of Arkansas, the 1985 NCAA champion, posted the fastest time (45.50) in the five qualifying heats of the men's 400.

Sunder Nix, the 1983 champion, also won his heat, in 45.91, but Mark Rowe, the two-time defending champion, failed to advance to Friday's semifinals.

Pitcher's homer lets Phils sink Cards

PHILADELPHIA (AP) — Pitcher Kevin Gross' second career homer keyed a four-run fifth inning and Mike Schmidt also homered Thursday night, leading the Philadelphia Phillies past the St. Louis Cardinals 5-3.

Gross, 6-5, gave up six hits in 8 2/3 innings. Don Carman got the final out for his first save.

The Phillies slipped a scoreless tie in the fifth. Glenn Wilson walked, Darren Daulton topped a single down the third-base line and Steve Jeltz hit an RBI double.

Gross then connected on the first pitch from St. Louis starter Ray Burris, 3-3, for his first home run since last Aug. 25.

Schmidt led off the bottom of the sixth with his 11th home run of the season and the 46th of his career. The homer, on the second pitch by reliever Greg Bargar, extended Schmidt's hitting streak to eight

National

games and gave the Phillies a 5-2 lead.

Padres 8, Giants 3

DIABLO (AP) — Graig Nettles hit two two-run homers and Gary Templeton tripled in two runs as the San Diego Padres defeated the San Francisco Giants 8-3 Thursday afternoon.

The two homers gave Nettles 12 for the season and 300 for his career, moving him past Orlando Cepeda into 15th place on the all-time homer list.

San Diego scored two in the sixth on walks to Marvell Wynne and Nettles then the triple by Templeton,

who has 10 RBI in his last eight games.

Dodgers 9, Braves 4

ATLANTA (AP) — Steve Sax had three hits, knocked in two runs and scored twice Thursday night to pace the Los Angeles Dodgers to a 9-4 victory over the Atlanta Braves.

Franklin Stubbs and Alex Trevino added late home runs during the Dodgers' 15th-inning attack.

Astros 6, Reds 2

CINCINNATI (AP) — Glenn Davis hit a two-run home run, sparking a 15-inning attack Thursday night that led the Houston Astros to a 6-2 victory over the Cincinnati Reds.

Davis' 14th homer of the season capped a three-run first inning against Mario Soto, 3-7. Bill Doran left off with a double and scored on a

single by Jose Cruz before Davis homered.

Doran hit an RBI single in the second off reliever Joe Price and Alan Ashby doubled home another run in the third. Doran drew a bases-loaded walk in the fifth off Scott Terry.

Pirates 4, Expos 2

MONTREAL (AP) — Barry Bonds homered and Joe Orsulak rapped three hits Thursday night as the Pittsburgh Pirates beat the Montreal Expos 4-2.

Montreal starter Bryn Smith, 4-5, retired the first nine batters he faced before Bonds led off the fourth inning with his fifth homer of the year. Orsulak followed with a single to center and scored on Johnny Ray's double.

Montreal took the lead in the third when Mitch Webster walked and scored on Vance LaRue's double.

Rangers nip A's to protect league lead

ARLINGTON, Texas (AP) — Rookie Edwin Correa pitched a four-hitter and Steve Buechele and Orlin McDevall homered as the Texas Rangers beat the Oakland Athletics 5-2 Thursday night to end a five-game losing streak and retain undisputed possession of first place in the American League West.

Correa, 5-1, outdueled Oakland rookie Eric Plunk, 1-5, who allowed six hits and struck out eight before being relieved in the seventh.

The victory increased Texas' division lead to one game over the idle California Angels.

White Sox 9, Twins 8

MINNEAPOLIS (AP) — Carlton Fisk and Ron Kittle hit solo homers for Chicago and led the White Sox to a record six runs in the sixth inning and hung on for a 9-8 victory over the Minnesota Twins on Thursday.

The White Sox entered the sixth trailing 5-3, but Bobby Bonilla doubled in one run, a second scored on an

American

infield out and Wayne Tolleson singled in the go-ahead run.

Joel Skinner singled in Tolleson and John Cangello doubled in another before Fisk hit a sacrifice fly for the decisive run and a 9-5 lead.

Randy Rush pulled the Twins within one run in the seventh with a three-run homer, his fourth.

Indians 8, Mariners 1

CLEVELAND (AP) — Tony Bernazard, Joe Carter and Mel Hall homered in the first inning and Tom Candiotti pitched a five-hitter Thursday night, leading the Cleveland Indians to an 8-1 victory over the Seattle Mariners.

Bernazard and Carter hit consecutive home runs with one out in the first off Mike Moore, 3-7. After Andre Thornton walked, Hall hit a

two-run shot to straightaway center field for a 4-0 lead. Bernazard's homer was his fourth of the season. Carter's his 10th and Hall's his ninth.

Tigers 7, Orioles 5

BALTIMORE (AP) — Pinch hitter Darrel Evans singled home the tying and lead runs in the eighth inning and Lou Whitaker added a two-run homer to cap off the Detroit Tigers beat the Baltimore Orioles 7-5 Thursday night for a sweep of their four-game series.

Evans came through against Baltimore relief ace Don Anz, 2-3, who has saved seven of the Orioles' last nine victories.

Blue Jays 10, Yankees 9

TORONTO (AP) — Damaso Garcia doubled off the center-field wall to score Willie Upshaw from second base in the 10th inning and give the Toronto Blue Jays a wild 10-9 victory

over the slumping New York Yankees on Thursday night.

Upshaw, who hadn't homered since the third game of the season but hit a three-run shot to start Toronto's scoring in the second inning, started the 10th with a single off Yankee relief ace Dave Righetti, 4-4.

Back Matty's sacrifice bunt, followed by first baseman Don Mattingly, whose throw to second was late. Garcia then drilled his game-winning hit over the head of center fielder Ricky Henderson, sending the Yankees to their fifth straight loss.

Scores and Stats

| Team | Score | Opponent | Score |
|--------------|-------|---------------|-------|
| Philadelphia | 5 | St. Louis | 3 |
| San Diego | 8 | San Francisco | 3 |
| Los Angeles | 9 | Atlanta | 4 |
| Houston | 6 | Cincinnati | 2 |
| Pittsburgh | 4 | Montreal | 2 |
| Texas | 5 | Oakland | 2 |
| Chicago | 9 | Minnesota | 8 |
| Cleveland | 8 | Seattle | 1 |
| Detroit | 7 | Baltimore | 5 |
| Toronto | 10 | New York | 9 |

Softball

| Team | Score | Opponent | Score |
|-------------|-------|-------------|-------|
| Idaho State | 5 | Boise State | 4 |
| Idaho | 3 | Boise State | 2 |
| Idaho State | 1 | Boise State | 0 |

Baseball

NL standings

| Team | W | L | Pct. |
|---------------|----|----|------|
| St. Louis | 46 | 16 | .743 |
| Philadelphia | 38 | 24 | .613 |
| San Diego | 37 | 25 | .597 |
| Los Angeles | 36 | 26 | .577 |
| Atlanta | 34 | 28 | .550 |
| San Francisco | 34 | 28 | .550 |
| Montreal | 33 | 29 | .533 |
| New York | 32 | 30 | .514 |
| Chicago | 31 | 31 | .500 |
| Baltimore | 29 | 33 | .467 |
| Cincinnati | 28 | 34 | .448 |
| Houston | 27 | 35 | .438 |
| Pittsburgh | 26 | 36 | .419 |
| Washington | 25 | 37 | .406 |
| San Diego | 25 | 37 | .406 |
| Los Angeles | 24 | 38 | .386 |
| Philadelphia | 24 | 38 | .386 |
| St. Louis | 23 | 39 | .367 |
| Atlanta | 22 | 40 | .353 |
| San Francisco | 21 | 41 | .341 |
| Montreal | 20 | 42 | .327 |
| New York | 19 | 43 | .311 |
| Chicago | 18 | 44 | .294 |
| Baltimore | 17 | 45 | .277 |
| Cincinnati | 16 | 46 | .261 |
| Houston | 15 | 47 | .245 |
| Pittsburgh | 14 | 48 | .228 |
| Washington | 13 | 49 | .212 |

AL standings

| Team | W | L | Pct. |
|---------------|----|----|------|
| Seattle | 45 | 17 | .726 |
| Los Angeles | 37 | 25 | .597 |
| California | 35 | 27 | .564 |
| Minnesota | 34 | 28 | .550 |
| Texas | 33 | 29 | .533 |
| Chicago | 32 | 30 | .514 |
| Atlanta | 31 | 31 | .500 |
| San Diego | 30 | 32 | .486 |
| Oakland | 29 | 33 | .467 |
| Minnesota | 28 | 34 | .448 |
| San Francisco | 27 | 35 | .438 |
| California | 26 | 36 | .419 |
| Seattle | 25 | 37 | .406 |
| Los Angeles | 24 | 38 | .386 |
| California | 23 | 39 | .367 |
| Minnesota | 22 | 40 | .353 |
| Texas | 21 | 41 | .341 |
| Chicago | 20 | 42 | .327 |
| Atlanta | 19 | 43 | .311 |
| San Diego | 18 | 44 | .294 |
| Oakland | 17 | 45 | .277 |
| Minnesota | 16 | 46 | .261 |
| San Francisco | 15 | 47 | .245 |
| California | 14 | 48 | .228 |
| Seattle | 13 | 49 | .212 |
| Los Angeles | 12 | 50 | .194 |
| California | 11 | 51 | .178 |
| Minnesota | 10 | 52 | .162 |
| Texas | 9 | 53 | .145 |
| Chicago | 8 | 54 | .129 |
| Atlanta | 7 | 55 | .113 |
| San Diego | 6 | 56 | .097 |
| Oakland | 5 | 57 | .081 |
| Minnesota | 4 | 58 | .065 |
| San Francisco | 3 | 59 | .049 |
| California | 2 | 60 | .033 |
| Seattle | 1 | 61 | .017 |

Northcutt nears U.S. rodeo title

BOZEMAN, Mont. — Frank Northcutt is within an eyelash of the bareback riding championship, an event that will determine the final finish of College of Southern Idaho's men's team in the Collegiate Rodeo Finals.

Northcutt leads a contingent of four Golden Eagles who have a good chance of landing in the bareback finals Saturday night as CSIS battles against a powerful Montana State crew for a high team finish.

"Everyone has to perform well, but on the other hand, Frank Northcutt is in the driver's seat for here and the national title," said CSIS Coach Shawn Davis. "I think we will have a good shot at the team title."

But the Eagles are still in seventh place overall in team standings and, according to Davis, "the bareback event is it. Everyone else has struck

Tennis deadline nears

TWIN FALLS — Entry deadline is Saturday for *The Times-News* Twin Falls Open Tennis Championships, which will be played here June 27-29.

This U.S. Tennis Association-sanctioned tournament will feature singles, doubles and mixed doubles in open, 4.5, 4.0, 3.5, 3.0 and over, 4.5-and-over and 55-and-over classes.

Play will begin Friday, June 27, at 6 p.m. Tournament headquarters will be at Frontier Field.

Further information can be obtained by phoning Andy or Lora Crane at 734-6197.

Flying poker run goes Saturday

POCATELLO — The Eastern Idaho 99s are sponsoring their second annual Flying Poker Run Saturday.

The money goes to the service and education projects sponsored by the Flying 99s, a group of eastern Idaho aviation enthusiasts.

The poker run is open to all pilots and passengers of participating aircraft, flying out of Jerome, Arco, Preston, Idaho Falls and Pocatello. Each player starts at the airport of his choice as early as 8 a.m. Saturday and picks up a playing card from each airport for \$3. When each player has five cards, he turns in his poker hand at the Northwest Aviation office at the Pocatello Municipal Airport. All cards must be turned in by 3 p.m.

There will be three winners. The holder of the best hand will receive 25 percent of the proceeds, the runner-up 15 percent and the third-place finisher 10 percent. The rest of the money goes to charity.

Participants can purchase more than one card at each airport.

There will be a barbecue following the poker run at the Pocatello airport.

Further information can be obtained by phoning Louise McBride at 886-2236 or 886-2963.

Lutz wins junior tourney

KETCHUM — Rafe Lutz of Ketchum was the overall winner with a score of 74 at the Idaho Junior Golf Tournament Tuesday.

Lutz also won first place in the boys' 16-17-year-old division in the tournament, played on Bigwood Golf Course here and at Elkhorn in Sun Valley.

The event was one in a summer-long series of golf tournaments held at courses through the Magic Valley.

Briefly in Sports

Tennis deadline nears

TWIN FALLS — Entry deadline is Saturday for *The Times-News* Twin Falls Open Tennis Championships, which will be played here June 27-29.

This U.S. Tennis Association-sanctioned tournament will feature singles, doubles and mixed doubles in open, 4.5, 4.0, 3.5, 3.0 and over, 4.5-and-over and 55-and-over classes.

Play will begin Friday, June 27, at 6 p.m. Tournament headquarters will be at Frontier Field.

Further information can be obtained by phoning Andy or Lora Crane at 734-6197.

Flying poker run goes Saturday

POCATELLO — The Eastern Idaho 99s are sponsoring their second annual Flying Poker Run Saturday.

The money goes to the service and education projects sponsored by the Flying 99s, a group of eastern Idaho aviation enthusiasts.

The poker run is open to all pilots and passengers of participating aircraft, flying out of Jerome, Arco, Preston, Idaho Falls and Pocatello. Each player starts at the airport of his choice as early as 8 a.m. Saturday and picks up a playing card from each airport for \$3. When each player has five cards, he turns in his poker hand at the Northwest Aviation office at the Pocatello Municipal Airport. All cards must be turned in by 3 p.m.

There will be three winners. The holder of the best hand will receive 25 percent of the proceeds, the runner-up 15 percent and the third-place finisher 10 percent. The rest of the money goes to charity.

Participants can purchase more than one card at each airport.

There will be a barbecue following the poker run at the Pocatello airport.

Further information can be obtained by phoning Louise McBride at 886-2236 or 886-2963.

Lutz wins junior tourney

KETCHUM — Rafe Lutz of Ketchum was the overall winner with a score of 74 at the Idaho Junior Golf Tournament Tuesday.

Lutz also won first place in the boys' 16-17-year-old division in the tournament, played on Bigwood Golf Course here and at Elkhorn in Sun Valley.

The event was one in a summer-long series of golf tournaments held at courses through the Magic Valley.

Nampa hosts TAC meet

NAMPA — The Snake River TAC Association Junior Olympic meet will be held Saturday, June 21 at Nampa High School.

The top six place winners in age categories ranging from eight to 18 will advance to the regional Junior Olympics July 25 in Missoula, Mont.

For further information contact Jeff Hoskisson at 733-1274 or Tim Severa at 341-5501.

Jackpot barrel race planned

GOODING — James arena in Gooding will be the site of a weekend jackpot barrel race this weekend.

Competitions will be held in barrel racing, pole bending and goat tying for the ladies with a separate entry fee for each event beginning at 6 p.m. Sunday, June 22.

Those interested in competing may sign up for their events at the arena.

Team ropers vie Sunday

NAMPA — The second in a summer series of team ropings will be held at Cactus Pete's Desert Arena in Jackpot, Nevada Sunday, June 22.

The two-part event will begin at 1 p.m. according to event coordinator Zeb Hill.

Kicking off the day's activities is a "two-for-five" (two steers for \$5) competition followed by another consisting of three steers for \$8. A total of \$250 in added money will apply in the latter roping.

Gooding slates horse show

GOODING — The Idaho State Horse Show Association will conduct a show beginning at 8:30 a.m. Saturday at the Gooding County Fairgrounds.

Youth classes will cost \$2.50 and adults class are \$3.50.

Class lists are available at Pedersen's, Vickie's, Maties or Wolco in Twin Falls.

More information may be obtained from Carol France at 934-5743.

Frazier to test Tyson

GLENS FALLS, N.Y. (AP) — A heavyweight fight between Marvin Frazier and undefeated Mike Tyson will be held on Saturday, July 25 at the Glens Falls Civic Center, promoters announced Thursday.

Jeff Levine of HBA East promotions said the fight card would begin at 7 p.m. and be televised live by ABC.

Cowboys face twice against Pocatello

POCATELLO — Unearned runs were the difference Thursday night when Pocatello knocked off Twin Falls' Cowboys 3-2 and 13-8 in an American Legion double-header.

An error led the deciding run score in the fifth inning of the opener and hung the loss on Kevin Ames. Pocatello's Bob Jenkins won the pitcher's duel, holding the Bruins to just three hits.

Two of those came in the second when Shane Clark drew a walk and Mike Buster tripled him home, then led in seconds later when Danny Hite singled.

But after that, Jenkins was virtually untouchable.

In the nightcap, Twin Falls committed five of its seven errors in a nine-run fifth inning and ate up a 5-3 Cowboy lead going into the frame.

Mike Buster and Barry Smith accounted for three RBIs as Twin Falls tried to rally in the seventh but could come-up only with three runs. In the first inning, singles by Ames and Nick Baumert set up a two-run double for Rob Ellis.

The Cowboys will host Mountain Home in a twinbill, slated for 6 p.m. Saturday at Frontier Field, and remain in town for another double-header with Meridian at 7 p.m. Sunday.

Pocatello 3, Twin Falls 2
Twin Falls 5, Pocatello 3
Pocatello 13, Twin Falls 8

W-Jenkins-L Ames
W-Baumert-Clark

Pocatello 13, Twin Falls 8

Twin Falls 8-0-0
Pocatello 13-0-0
W-Jenkins-L Ames
W-Baumert-Clark

Pocatello 3, Twin Falls 2

Twin Falls 3-0-0
Pocatello 13-0-0
W-Jenkins-L Ames
W-Baumert-Clark

Wells PRCA Rodeo
June 28 - 29
SHOWS:
Saturday - 11 AM
1 pm and 5 pm
Sunday
1 pm
June 29
8 PM Friday
12 PM Saturday
Under 12 - \$100
Wells City Park

Bar-B-Que
8 PM Friday
12 PM Saturday
Under 12 - \$100
Wells City Park

Rodeo Admissions:
18 and up \$4.00
6 and up \$2.00
Free

PERFORMANCE
PASS
\$100

ADDED PRIZE MONEY SPONSORS:
Sierra Wine & Liquor
Ranch House & Casio
Belle's
IGT Sells
Bole Homes



Curtis Hall kneels beside one of the face-branded cattle he will sell under the dairy buyout. AP Laserphoto

After bad year, buyout came at right time for this farmer

By ROBERT O'MEARA
The Associated Press

MEQUON, Wis. — Curtis Hall's dairy farm with its big red barn has been in his family since 1888.

"It's always been a dairy farm, there's always been cattle here," said Hall.

But now Hall, 29, and his wife Suzanne, who have made their living by producing milk in America's Dairyland, have joined the government's whole-herd dairy buyout program and are getting rid of their cows.

"It's kind of sad to see all your cows go," Hall said, walking among the face-branded cattle in the barnyard. "It's like watching your pet dog get killed on the road. They have their own personalities, dumb as they may be."

"The Halls are joining the 1,621 other Wisconsin farmers and 13,968 nationwide whose bids to sell off their dairy herds were accepted by the federal government. They'll be paid to dispose of their cattle and stay out of the business for five years to reduce government purchases of surplus dairy products.

The change won't be pleasant for this farmer in Ozaukee County, just north of Milwaukee.

"I'm a small farmer, but I always intended to grow, to develop a big

herd," he said. "There was always the thought of a big barn with 100 cattle that you can pass along to your kids. That's how a farmer gets satisfaction, watching his herd develop."

But now Hall feels the herd buyout program came along at just the right time.

Last year, his 3-year-old son Adam suffocated when a feed box he was playing on in the barn collapsed. In that dark period, the corn and the hay they feed their cattle got planted late.

Then, a bull managed to breed nearly three-quarters of their Holsteins, reducing milk production.

"I didn't pay much attention to what the bull was doing," Hall said. "So I had the barn full of cows that weren't producing milk. I was feeding 80-90 head of cattle and milking 16," he said.

"Farming doesn't leave any leeway for personal tragedy," said Mrs. Hall, 26. "Friends can only do so much."

And like other farmers, the Halls were caught up by higher operating costs.

They rent the farm buildings, including a 45-to 50-acre dairy frame house, and his two parents for \$1,000 a month. Up to \$5,000 more a year goes

for renting more land that brings their farm to a total 150 acres.

They've been paying \$3,000 a month since December to buy feed for their cows, while the monthly check for their milk was as low as \$700 in January and February.

In addition, they were borrowing from banks to pay for farm equipment.

So the estimated \$100,000 that will come from the buyout looks good to the Halls. They are looking forward not only to their first vacation in years but to the education of their three children, Cate, G, Dionne, 3, and Nicholas, 1.

Hall figures that within a year he'll be looking for an off-farm job.

Hall said he had 29 milking cows and 37 young stock when he was accepted into the buyout program. He has gotten rid of 14 of the cows and all the younger animals and must sell the remainder by Aug. 31. He could be fed \$5,000 a head if he keeps any beyond that date.

So that the cattle can't be hidden sold to another farm for milk production, the U.S. Department of Agriculture requires they be branded on their faces with a 4-inch by 4-inch mark.

"We put it off as long as possible," Hall said. "If we didn't have to do it we didn't want it done."

Personal income dips but spending climbs

By MARTIN CRUTSINGER
The Associated Press

WASHINGTON — Americans' personal incomes, held back by weak growth in wages and salaries, fell 0.1 percent in May for the first decline in a year, the government reported Thursday.

The income decline was accompanied, however, by a strong 0.9 percent increase in consumer spending, the best advance in five months, led by gains in car sales.

Still, many analysts worried that consumer spending will slow in the months ahead because of continued weakness in income growth.

"If we don't get some improvement in the job market and in wage growth, I don't see how much longer the consumer can keep carrying the economy," said Sandra Shaber, director of consumer economics at Chase Econometrics, a forecasting concern.

The 0.1 percent income decline, which followed a 1.2 percent jump in April, was the first downturn since a 0.5 percent drop in May 1985.

The April rise and the May decline were both exaggerated by a big swing in government subsidy payments to farmers, which soared in April only to plunge back to normal levels last month.

Excluding the subsidy payments, personal income would have risen 0.3 percent in April and 0.4 percent in May.

Still, analysts expressed concern that wage and salary growth has

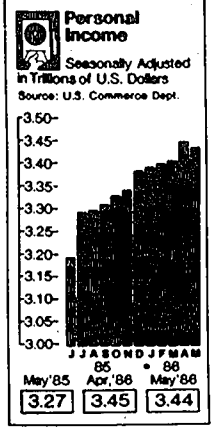

patterns better than other income components.

The 0.9 percent jump in personal consumption spending last month was the strongest increase since a 1.8 percent advance in December. It followed a 0.5 percent April gain.

The rise was fueled by strong increases in purchases of both durable and non-durable goods. Purchases of durable goods, items expected to last three or more years, rose at an annual rate of \$13 billion in May after advancing at a \$15.2 billion rate in April, reflecting strength in car sales in both months.

Purchases of non-durable goods climbed \$5 billion in May after falling \$9.7 billion in April. Analysts attributed the gain to an upturn in clothing sales.

Michael Evans, head of a Washington consulting firm, was unimpressed by the increases, saying the strength in auto sales was coming from dealer incentives aimed at reducing record levels of unsold cars and would not spur increased vehicle production.

Americans had to dip into savings to finance their May spending spree, pushing the savings rate down a full percentage point to 4.3 percent in May.

Personal income fell \$11.5 billion in May after soaring by \$33.3 billion in April. The wide swing came from government subsidy payments that surged in April because they included advance payments for 1986 and final payments for 1985.

Blue chips sag, Dow closes lower

NEW YORK (AP) — The stock market finished lower Thursday as the blue chips sagged amid some late selling.

The Dow Jones average of 30 Industrials changed direction a number of times. It stayed close to Wednesday's closing level for most of the final few minutes.

Excluding the stock index, the blue chip indicator to its lowest level of the day and left it with a 13.08-point loss at 1,655.86.

Losing issues outnumbered gainers by about 4:3 on the New York Stock Exchange. Volume on the Big Board came to 129.9 million shares, up from 117.0 million shares on Wednesday.

The market's erratic behavior was partly caused by apprehension on the eve of a "triple witching hour" which occurs on the last trading day for a set of futures contracts on stock indexes, options on stock indexes, and options on individual stocks.

The computer-driven buying and selling maneuvers used by professionals on such days has occasionally caused wide price swings.

Stock traders, therefore, shied away from the market, remembering that on the last triple-expiration date, March 21, the Dow Jones industrial average slid 35.68 points, with most of the slide coming in the final few minutes.

Analysts said the market's recent meandering movements and lackluster trading volume also reflects investors' concern that economic growth is not more robust.

Dart & Kraft was one of the most heavily traded stocks, gaining 3/4 to 69 3/4, a 52-week high. The

diversified food firm announced plans to split into two independent companies.

Chromalloy American, another active issue, moved ahead by 2 1/2 to 23 1/2, also a 52-week high. Sun Chemical said it seeking to acquire the 64 percent of Chromalloy it does not already own.

Safety Stores, which faces a takeover threat from Dart Group, fell 1/4 to 48 1/2.

International Business Machines, which sported a modest gain in the early afternoon, closed down 1 1/2 to 145. Some other technology issues fared better: Chromalloy fell 1/4 to 48 1/2, already owned by Digital Equipment was up 3/4 to 84 1/2, and Motorola rose 1/2 to 130.

R.H. Macy closed unchanged at 67 1/2. Shareholders voted on Thursday to accept an offer from Macy's top managers to buy the retailer for \$3.7 billion and turn it into a private company.

The NYSE's composite index of all its listed common stocks declined 0.43 to 140.29. Losing issues on the Big Board totaled 447, gainers came to 664 while 444 issues were unchanged.

At the American Stock Exchange, the market value index rose 0.58 to 261.19.

Nationwide turnover in NYSE-listed issues, including trades in those stocks on regional exchanges and in the over-the-counter market, totaled 147.73 million shares.

Standard & Poor's index of 400 industrial stocks fell 1.21 to 272.92, and S&P's 500-stock composite index finished down 0.93 at 244.06.

The NASDAQ composite index for the over-the-counter market moved up by 1.16 to 396.40.

Closing prices

| NEW YORK (AP)—Thursday 6 p.m. National prices for New York Stock Exchange issues | PE Sales | Chg. | NEW YORK (AP)—Thursday 4 p.m. National prices for American Stock Exchange issues | PE Sales | Chg. |
|---|----------|--------|---|----------|--------|
| AAIR | 11 | 1/2 | AAIR | 11 | 1/2 |
| ABR | 7 | 5/8 | ABR | 7 | 5/8 |
| AC | 10 | 3/4 | AC | 10 | 3/4 |
| ADP | 277 | 12 1/2 | ADP | 277 | 12 1/2 |
| AG | 14 | 1/2 | AG | 14 | 1/2 |
| AGI | 264 | 11 1/2 | AGI | 264 | 11 1/2 |
| AIG | 52 | 1/2 | AIG | 52 | 1/2 |
| AIR | 15 | 5/8 | AIR | 15 | 5/8 |
| AKR | 52 | 1/2 | AKR | 52 | 1/2 |
| ALC | 14 | 1/2 | ALC | 14 | 1/2 |
| ALD | 14 | 1/2 | ALD | 14 | 1/2 |
| AMC | 14 | 1/2 | AMC | 14 | 1/2 |
| AME | 14 | 1/2 | AME | 14 | 1/2 |
| AMP | 14 | 1/2 | AMP | 14 | 1/2 |
| ANR | 14 | 1/2 | ANR | 14 | 1/2 |
| APC | 14 | 1/2 | APC | 14 | 1/2 |
| APD | 14 | 1/2 | APD | 14 | 1/2 |
| APF | 14 | 1/2 | APF | 14 | 1/2 |
| APG | 14 | 1/2 | APG | 14 | 1/2 |
| APK | 14 | 1/2 | APK | 14 | 1/2 |
| APL | 14 | 1/2 | APL | 14 | 1/2 |
| APM | 14 | 1/2 | APM | 14 | 1/2 |
| APN | 14 | 1/2 | APN | 14 | 1/2 |
| APQ | 14 | 1/2 | APQ | 14 | 1/2 |
| APR | 14 | 1/2 | APR | 14 | 1/2 |
| APS | 14 | 1/2 | APS | 14 | 1/2 |
| APT | 14 | 1/2 | APT | 14 | 1/2 |
| APU | 14 | 1/2 | APU | 14 | 1/2 |
| APV | 14 | 1/2 | APV | 14 | 1/2 |
| APW | 14 | 1/2 | APW | 14 | 1/2 |
| APX | 14 | 1/2 | APX | 14 | 1/2 |
| APY | 14 | 1/2 | APY | 14 | 1/2 |
| APZ | 14 | 1/2 | APZ | 14 | 1/2 |
| AQ | 14 | 1/2 | AQ | 14 | 1/2 |
| AQR | 14 | 1/2 | AQR | 14 | 1/2 |
| AQS | 14 | 1/2 | AQS | 14 | 1/2 |
| AQT | 14 | 1/2 | AQT | 14 | 1/2 |
| AQU | 14 | 1/2 | AQU | 14 | 1/2 |
| AQV | 14 | 1/2 | AQV | 14 | 1/2 |
| AQW | 14 | 1/2 | AQW | 14 | 1/2 |
| AQX | 14 | 1/2 | AQX | 14 | 1/2 |
| AQY | 14 | 1/2 | AQY | 14 | 1/2 |
| AQZ | 14 | 1/2 | AQZ | 14 | 1/2 |
| AR | 14 | 1/2 | AR | 14 | 1/2 |
| ARA | 14 | 1/2 | ARA | 14 | 1/2 |
| ARB | 14 | 1/2 | ARB | 14 | 1/2 |
| ARC | 14 | 1/2 | ARC | 14 | 1/2 |
| ARD | 14 | 1/2 | ARD | 14 | 1/2 |
| ARE | 14 | 1/2 | ARE | 14 | 1/2 |
| ARF | 14 | 1/2 | ARF | 14 | 1/2 |
| ARG | 14 | 1/2 | ARG | 14 | 1/2 |
| ARI | 14 | 1/2 | ARI | 14 | 1/2 |
| ARJ | 14 | 1/2 | ARJ | 14 | 1/2 |
| ARK | 14 | 1/2 | ARK | 14 | 1/2 |
| ARL | 14 | 1/2 | ARL | 14 | 1/2 |
| ARM | 14 | 1/2 | ARM | 14 | 1/2 |
| ARN | 14 | 1/2 | ARN | 14 | 1/2 |
| ARO | 14 | 1/2 | ARO | 14 | 1/2 |
| ARQ | 14 | 1/2 | ARQ | 14 | 1/2 |
| ARR | 14 | 1/2 | ARR | 14 | 1/2 |
| ARS | 14 | 1/2 | ARS | 14 | 1/2 |
| ART | 14 | 1/2 | ART | 14 | 1/2 |
| ARU | 14 | 1/2 | ARU | 14 | 1/2 |
| ARV | 14 | 1/2 | ARV | 14 | 1/2 |
| ARW | 14 | 1/2 | ARW | 14 | 1/2 |
| ARX | 14 | 1/2 | ARX | 14 | 1/2 |
| ARY | 14 | 1/2 | ARY | 14 | 1/2 |
| ARZ | 14 | 1/2 | ARZ | 14 | 1/2 |
| AS | 14 | 1/2 | AS | 14 | 1/2 |
| ASA | 14 | 1/2 | ASA | 14 | 1/2 |
| ASB | 14 | 1/2 | ASB | 14 | 1/2 |
| ASC | 14 | 1/2 | ASC | 14 | 1/2 |
| ASD | 14 | 1/2 | ASD | 14 | 1/2 |
| ASE | 14 | 1/2 | ASE | 14 | 1/2 |
| ASF | 14 | 1/2 | ASF | 14 | 1/2 |
| ASG | 14 | 1/2 | ASG | 14 | 1/2 |
| ASH | 14 | 1/2 | ASH | 14 | 1/2 |
| ASJ | 14 | 1/2 | ASJ | 14 | 1/2 |
| ASK | 14 | 1/2 | ASK | 14 | 1/2 |
| ASL | 14 | 1/2 | ASL | 14 | 1/2 |
| ASM | 14 | 1/2 | ASM | 14 | 1/2 |
| ASN | 14 | 1/2 | ASN | 14 | 1/2 |
| ASO | 14 | 1/2 | ASO | 14 | 1/2 |
| ASP | 14 | 1/2 | ASP | 14 | 1/2 |
| ASQ | 14 | 1/2 | ASQ | 14 | 1/2 |
| ASR | 14 | 1/2 | ASR | 14 | 1/2 |
| ASX | 14 | 1/2 | ASX | 14 | 1/2 |
| ASY | 14 | 1/2 | ASY | 14 | 1/2 |
| ASZ | 14 | 1/2 | ASZ | 14 | 1/2 |
| AT | 14 | 1/2 | AT | 14 | 1/2 |
| ATA | 14 | 1/2 | ATA | 14 | 1/2 |
| ATB | 14 | 1/2 | ATB | 14 | 1/2 |
| ATC | 14 | 1/2 | ATC | 14 | 1/2 |
| ATD | 14 | 1/2 | ATD | 14 | 1/2 |
| ATE | 14 | 1/2 | ATE | 14 | 1/2 |
| ATF | 14 | 1/2 | ATF | 14 | 1/2 |
| ATG | 14 | 1/2 | ATG | 14 | 1/2 |
| ATH | 14 | 1/2 | ATH | 14 | 1/2 |
| ATI | 14 | 1/2 | ATI | 14 | 1/2 |
| ATJ | 14 | 1/2 | ATJ | 14 | 1/2 |
| ATK | 14 | 1/2 | ATK | 14 | 1/2 |
| ATL | 14 | 1/2 | ATL | 14 | 1/2 |
| ATM | 14 | 1/2 | ATM | 14 | 1/2 |
| ATN | 14 | 1/2 | ATN | 14 | 1/2 |
| ATO | 14 | 1/2 | ATO | 14 | 1/2 |
| ATP | 14 | 1/2 | ATP | 14 | 1/2 |
| ATQ | 14 | 1/2 | ATQ | 14 | 1/2 |
| ATR | 14 | 1/2 | ATR | 14 | 1/2 |
| ATS | 14 | 1/2 | ATS | 14 | 1/2 |
| ATT | 14 | 1/2 | ATT | 14 | 1/2 |
| ATU | 14 | 1/2 | ATU | 14 | 1/2 |
| ATV | 14 | 1/2 | ATV | 14 | 1/2 |
| ATW | 14 | 1/2 | ATW | 14 | 1/2 |
| ATX | 14 | 1/2 | ATX | 14 | 1/2 |
| ATY | 14 | 1/2 | ATY | 14 | 1/2 |
| ATZ | 14 | 1/2 | ATZ | 14 | 1/2 |
| AV | 14 | 1/2 | AV | 14 | 1/2 |
| AVA | 14 | 1/2 | AVA | 14 | 1/2 |
| AVB | 14 | 1/2 | AVB | 14 | 1/2 |
| AVC | 14 | 1/2 | AVC | 14 | 1/2 |
| AVD | 14 | 1/2 | AVD | 14 | 1/2 |
| AVE | 14 | 1/2 | AVE | 14 | 1/2 |
| AVF | 14 | 1/2 | AVF | 14 | 1/2 |
| AVG | 14 | 1/2 | AVG | 14 | 1/2 |
| AVH | 14 | 1/2 | AVH | 14 | 1/2 |
| AVI | 14 | 1/2 | AVI | 14 | 1/2 |
| AVJ | 14 | 1/2 | AVJ | 14 | 1/2 |
| AVK | 14 | 1/2 | AVK | 14 | 1/2 |
| AVL | 14 | 1/2 | AVL | 14 | 1/2 |
| AVM | 14 | 1/2 | AVM | 14 | 1/2 |
| AVN | 14 | 1/2 | AVN | 14 | 1/2 |
| AVO | 14 | 1/2 | AVO | 14 | 1/2 |
| AVP | 14 | 1/2 | AVP | 14 | 1/2 |
| AVQ | 14 | 1/2 | AVQ | 14 | 1/2 |
| AVR | 14 | 1/2 | AVR | 14 | 1/2 |
| AVS | 14 | 1/2 | AVS | 14 | 1/2 |
| AVT | 14 | 1/2 | AVT</ | | |

Markets

Closing commodity futures

| Month | Commodity | Close | High | Low |
|-------|----------------|--------|--------|--------|
| May | Wheat | 4.19 | 4.19 | 4.19 |
| Aug. | live cattle | 53.70 | 54.20 | 53.40 |
| Jun. | live cattle | 55.57 | 56.35 | 55.02 |
| Aug. | feeder cattle | 59.81 | 59.80 | 59.20 |
| Jun. | live hogs | 56.75 | 57.25 | 56.22 |
| Jul. | wheat | 2.72 | 2.49 | 2.44 |
| Sep. | Port. wheat | 2.72 | 2.72 | 2.72 |
| Jul. | corn | 2.33 | 2.34 | 2.32 |
| Jul. | soybeans | 5.31 | 5.34 | 5.30 |
| Jun. | live pig | 5.05 | 5.10 | 5.05 |
| Jun. | gold | 337.90 | 339.00 | 337.50 |
| Jul. | platinum | 434.10 | 437.50 | 428.90 |
| Jul. | sugar | 6.53 | 6.63 | 6.44 |
| Sep. | Treasury Bills | 94.24 | 94.23 | 94.13 |
| Sep. | Treas. Bonds | 96.21 | 96.08 | 95.08 |
| Sep. | D-mark | 45.12 | 45.16 | 44.95 |
| Sep. | S-franc | 54.68 | 54.68 | 54.49 |
| Sep. | J-yen | 60.37 | 60.37 | 60.13 |
| Jul. | crude oil | 13.65 | 13.65 | 13.71 |

Local interest stock quotations

| Company | Close | Chg. |
|-----------------|--------|-------|
| Albertson | 42 1/2 | - 1/4 |
| Amor Hoyle Tr | 4 1/4 | + 1/4 |
| Sara Lee | 67 | - 1/2 |
| Community Psych | 23 3/4 | - 1/4 |
| Coors | 30 | - 1/2 |
| Micro Tech | 8 1/2 | + 1/2 |
| El Paso Elec | 15 1/4 | - 1/4 |
| Rky Mt. Nat Gas | 13 3/4 | - 1/4 |
| Int. Sec. Bank | 30 1/4 | - 1/4 |

Valley grains

Sold wheat 2.16, barley 4.70, mixed grain 2.00, and rye 1.50. Wheat quotes are given daily by Farmers' Grain Producers' Association. Barley quotes are given daily by Idaho Valley Grain Producers' Association. Rye quotes are given daily by Idaho Valley Grain Producers' Association. All prices are in cents per bushel. Home by Road Grain Co. in loading.

Commodities

| Commodity | Open | High | Low | Settle |
|---------------|------|------|------|--------|
| CASH POTATOES | | | | |
| 100 lbs. cwt. | 3.57 | 3.37 | 3.53 | 3.53 |
| 100 lbs. cwt. | 3.79 | 3.50 | 3.79 | 4.10 |
| May | 3.50 | 3.50 | 3.50 | 3.50 |
| June | 3.50 | 3.50 | 3.50 | 3.50 |
| July | 3.50 | 3.50 | 3.50 | 3.50 |
| Aug. | 3.50 | 3.50 | 3.50 | 3.50 |
| Sep. | 3.50 | 3.50 | 3.50 | 3.50 |
| Oct. | 3.50 | 3.50 | 3.50 | 3.50 |
| Nov. | 3.50 | 3.50 | 3.50 | 3.50 |
| Dec. | 3.50 | 3.50 | 3.50 | 3.50 |
| Jan. | 3.50 | 3.50 | 3.50 | 3.50 |
| Feb. | 3.50 | 3.50 | 3.50 | 3.50 |
| Mar. | 3.50 | 3.50 | 3.50 | 3.50 |
| Apr. | 3.50 | 3.50 | 3.50 | 3.50 |
| May | 3.50 | 3.50 | 3.50 | 3.50 |
| June | 3.50 | 3.50 | 3.50 | 3.50 |
| July | 3.50 | 3.50 | 3.50 | 3.50 |
| Aug. | 3.50 | 3.50 | 3.50 | 3.50 |
| Sep. | 3.50 | 3.50 | 3.50 | 3.50 |
| Oct. | 3.50 | 3.50 | 3.50 | 3.50 |
| Nov. | 3.50 | 3.50 | 3.50 | 3.50 |
| Dec. | 3.50 | 3.50 | 3.50 | 3.50 |
| Jan. | 3.50 | 3.50 | 3.50 | 3.50 |
| Feb. | 3.50 | 3.50 | 3.50 | 3.50 |
| Mar. | 3.50 | 3.50 | 3.50 | 3.50 |
| Apr. | 3.50 | 3.50 | 3.50 | 3.50 |
| May | 3.50 | 3.50 | 3.50 | 3.50 |
| June | 3.50 | 3.50 | 3.50 | 3.50 |
| July | 3.50 | 3.50 | 3.50 | 3.50 |
| Aug. | 3.50 | 3.50 | 3.50 | 3.50 |
| Sep. | 3.50 | 3.50 | 3.50 | 3.50 |
| Oct. | 3.50 | 3.50 | 3.50 | 3.50 |
| Nov. | 3.50 | 3.50 | 3.50 | 3.50 |
| Dec. | 3.50 | 3.50 | 3.50 | 3.50 |
| Jan. | 3.50 | 3.50 | 3.50 | 3.50 |
| Feb. | 3.50 | 3.50 | 3.50 | 3.50 |
| Mar. | 3.50 | 3.50 | 3.50 | 3.50 |
| Apr. | 3.50 | 3.50 | 3.50 | 3.50 |
| May | 3.50 | 3.50 | 3.50 | 3.50 |
| June | 3.50 | 3.50 | 3.50 | 3.50 |
| July | 3.50 | 3.50 | 3.50 | 3.50 |
| Aug. | 3.50 | 3.50 | 3.50 | 3.50 |
| Sep. | 3.50 | 3.50 | 3.50 | 3.50 |
| Oct. | 3.50 | 3.50 | 3.50 | 3.50 |
| Nov. | 3.50 | 3.50 | 3.50 | 3.50 |
| Dec. | 3.50 | 3.50 | 3.50 | 3.50 |
| Jan. | 3.50 | 3.50 | 3.50 | 3.50 |
| Feb. | 3.50 | 3.50 | 3.50 | 3.50 |
| Mar. | 3.50 | 3.50 | 3.50 | 3.50 |
| Apr. | 3.50 | 3.50 | 3.50 | 3.50 |
| May | 3.50 | 3.50 | 3.50 | 3.50 |
| June | 3.50 | 3.50 | 3.50 | 3.50 |
| July | 3.50 | 3.50 | 3.50 | 3.50 |
| Aug. | 3.50 | 3.50 | 3.50 | 3.50 |
| Sep. | 3.50 | 3.50 | 3.50 | 3.50 |
| Oct. | 3.50 | 3.50 | 3.50 | 3.50 |
| Nov. | 3.50 | 3.50 | 3.50 | 3.50 |
| Dec. | 3.50 | 3.50 | 3.50 | 3.50 |
| Jan. | 3.50 | 3.50 | 3.50 | 3.50 |
| Feb. | 3.50 | 3.50 | 3.50 | 3.50 |
| Mar. | 3.50 | 3.50 | 3.50 | 3.50 |
| Apr. | 3.50 | 3.50 | 3.50 | 3.50 |
| May | 3.50 | 3.50 | 3.50 | 3.50 |
| June | 3.50 | 3.50 | 3.50 | 3.50 |
| July | 3.50 | 3.50 | 3.50 | 3.50 |
| Aug. | 3.50 | 3.50 | 3.50 | 3.50 |
| Sep. | 3.50 | 3.50 | 3.50 | 3.50 |
| Oct. | 3.50 | 3.50 | 3.50 | 3.50 |
| Nov. | 3.50 | 3.50 | 3.50 | 3.50 |
| Dec. | 3.50 | 3.50 | 3.50 | 3.50 |
| Jan. | 3.50 | 3.50 | 3.50 | 3.50 |
| Feb. | 3.50 | 3.50 | 3.50 | 3.50 |
| Mar. | 3.50 | 3.50 | 3.50 | 3.50 |
| Apr. | 3.50 | 3.50 | 3.50 | 3.50 |
| May | 3.50 | 3.50 | 3.50 | 3.50 |
| June | 3.50 | 3.50 | 3.50 | 3.50 |
| July | 3.50 | 3.50 | 3.50 | 3.50 |
| Aug. | 3.50 | 3.50 | 3.50 | 3.50 |
| Sep. | 3.50 | 3.50 | 3.50 | 3.50 |
| Oct. | 3.50 | 3.50 | 3.50 | 3.50 |
| Nov. | 3.50 | 3.50 | 3.50 | 3.50 |
| Dec. | 3.50 | 3.50 | 3.50 | 3.50 |
| Jan. | 3.50 | 3.50 | 3.50 | 3.50 |
| Feb. | 3.50 | 3.50 | 3.50 | 3.50 |
| Mar. | 3.50 | 3.50 | 3.50 | 3.50 |
| Apr. | 3.50 | 3.50 | 3.50 | 3.50 |
| May | 3.50 | 3.50 | 3.50 | 3.50 |
| June | 3.50 | 3.50 | 3.50 | 3.50 |
| July | 3.50 | 3.50 | 3.50 | 3.50 |
| Aug. | 3.50 | 3.50 | 3.50 | 3.50 |
| Sep. | 3.50 | 3.50 | 3.50 | 3.50 |
| Oct. | 3.50 | 3.50 | 3.50 | 3.50 |
| Nov. | 3.50 | 3.50 | 3.50 | 3.50 |
| Dec. | 3.50 | 3.50 | 3.50 | 3.50 |
| Jan. | 3.50 | 3.50 | 3.50 | 3.50 |
| Feb. | 3.50 | 3.50 | 3.50 | 3.50 |
| Mar. | 3.50 | 3.50 | 3.50 | 3.50 |
| Apr. | 3.50 | 3.50 | 3.50 | 3.50 |
| May | 3.50 | 3.50 | 3.50 | 3.50 |
| June | 3.50 | 3.50 | 3.50 | 3.50 |
| July | 3.50 | 3.50 | 3.50 | 3.50 |
| Aug. | 3.50 | 3.50 | 3.50 | 3.50 |
| Sep. | 3.50 | 3.50 | 3.50 | 3.50 |
| Oct. | 3.50 | 3.50 | 3.50 | 3.50 |
| Nov. | 3.50 | 3.50 | 3.50 | 3.50 |
| Dec. | 3.50 | 3.50 | 3.50 | 3.50 |
| Jan. | 3.50 | 3.50 | 3.50 | 3.50 |
| Feb. | 3.50 | 3.50 | 3.50 | 3.50 |
| Mar. | 3.50 | 3.50 | 3.50 | 3.50 |
| Apr. | 3.50 | 3.50 | 3.50 | 3.50 |
| May | 3.50 | 3.50 | 3.50 | 3.50 |
| June | 3.50 | 3.50 | 3.50 | 3.50 |
| July | 3.50 | 3.50 | 3.50 | 3.50 |
| Aug. | 3.50 | 3.50 | 3.50 | 3.50 |
| Sep. | 3.50 | 3.50 | 3.50 | 3.50 |
| Oct. | 3.50 | 3.50 | 3.50 | 3.50 |
| Nov. | 3.50 | 3.50 | 3.50 | 3.50 |
| Dec. | 3.50 | 3.50 | 3.50 | 3.50 |
| Jan. | 3.50 | 3.50 | 3.50 | 3.50 |
| Feb. | 3.50 | 3.50 | 3.50 | 3.50 |
| Mar. | 3.50 | 3.50 | 3.50 | 3.50 |
| Apr. | 3.50 | 3.50 | 3.50 | 3.50 |
| May | 3.50 | 3.50 | 3.50 | 3.50 |
| June | 3.50 | 3.50 | 3.50 | 3.50 |
| July | 3.50 | 3.50 | 3.50 | 3.50 |
| Aug. | 3.50 | 3.50 | 3.50 | 3.50 |
| Sep. | 3.50 | 3.50 | 3.50 | 3.50 |
| Oct. | 3.50 | 3.50 | 3.50 | 3.50 |
| Nov. | 3.50 | 3.50 | 3.50 | 3.50 |
| Dec. | 3.50 | 3.50 | 3.50 | 3.50 |
| Jan. | 3.50 | 3.50 | 3.50 | 3.50 |
| Feb. | 3.50 | 3.50 | 3.50 | 3.50 |
| Mar. | 3.50 | 3.50 | 3.50 | 3.50 |
| Apr. | 3.50 | 3.50 | 3.50 | 3.50 |
| May | 3.50 | 3.50 | 3.50 | 3.50 |
| June | 3.50 | 3.50 | 3.50 | 3.50 |
| July | 3.50 | 3.50 | 3.50 | 3.50 |
| Aug. | 3.50 | 3.50 | 3.50 | 3.50 |
| Sep. | 3.50 | 3.50 | 3.50 | 3.50 |
| Oct. | 3.50 | 3.50 | 3.50 | 3.50 |
| Nov. | 3.50 | 3.50 | 3.50 | 3.50 |
| Dec. | 3.50 | 3.50 | 3.50 | 3.50 |
| Jan. | 3.50 | 3.50 | 3.50 | 3.50 |
| Feb. | 3.50 | 3.50 | 3.50 | 3.50 |
| Mar. | 3.50 | 3.50 | 3.50 | 3.50 |
| Apr. | 3.50 | 3.50 | 3.50 | 3.50 |
| May | 3.50 | 3.50 | 3.50 | 3.50 |
| June | 3.50 | 3.50 | 3.50 | 3.50 |
| July | 3.50 | 3.50 | 3.50 | 3.50 |
| Aug. | 3.50 | 3.50 | 3.50 | 3.50 |
| Sep. | 3.50 | 3.50 | 3.50 | 3.50 |
| Oct. | 3.50 | 3.50 | 3.50 | 3.50 |
| Nov. | 3.50 | 3.50 | 3.50 | 3.50 |
| Dec. | 3.50 | 3.50 | 3.50 | 3.50 |
| Jan. | 3.50 | 3.50 | 3.50 | 3.50 |
| Feb. | 3.50 | 3.50 | 3.50 | 3.50 |
| Mar. | 3.50 | 3.50 | 3.50 | 3.50 |
| Apr. | 3.50 | 3.50 | 3.50 | 3.50 |
| May | 3.50 | 3.50 | 3.50 | 3.50 |
| June | 3.50 | 3.50 | 3.50 | 3.50 |
| July | 3.50 | 3.50 | 3.50 | 3.50 |
| Aug. | 3.50 | 3.50 | 3.50 | 3.50 |
| Sep. | 3.50 | 3.50 | 3.50 | 3.50 |
| Oct. | 3.50 | 3.50 | 3.50 | 3.50 |
| Nov. | 3.50 | 3.50 | 3.50 | 3.50 |
| Dec. | 3.50 | 3.50 | 3.50 | 3.50 |
| Jan. | 3.50 | 3.50 | 3.50 | 3.50 |
| Feb. | 3.50 | 3.50 | 3.50 | 3.50 |
| Mar. | 3.50 | 3.50 | 3.50 | 3.50 |
| Apr. | 3.50 | 3.50 | 3.50 | 3.50 |
| May | 3.50 | 3.50 | 3.50 | 3.50 |
| June | 3.50 | 3.50 | 3.50 | 3.50 |
| July | 3.50 | 3.50 | 3.50 | 3.50 |
| Aug. | 3.50 | 3.50 | 3.50 | 3.50 |
| Sep. | 3.50 | 3.50 | 3.50 | 3.50 |
| Oct. | 3.50 | 3.50 | 3.50 | 3.50 |
| Nov. | 3.50 | 3.50 | 3.50 | 3.50 |
| Dec. | 3.50 | 3.50 | 3.50 | 3.50 |
| Jan. | 3.50 | 3.50 | 3.50 | 3.50 |
| Feb. | 3.50 | 3.50 | 3.50 | 3.50 |
| Mar. | 3.50 | 3.50 | 3.50 | 3.50 |
| Apr. | 3.50 | 3.50 | 3.50 | 3.50 |
| May | 3.50 | 3.50 | 3.50 | 3.50 |
| June | 3.50 | 3.50 | 3.50 | 3.50 |
| July | 3.50 | 3.50 | 3.50 | 3.50 |
| Aug. | 3.50 | 3.50 | 3.50 | 3.50 |
| Sep. | 3.50 | 3.50 | 3.50 | 3.50 |
| Oct. | 3.50 | 3.50 | 3.50 | 3.50 |
| Nov. | 3.50 | 3.50 | 3.50 | 3.50 |
| Dec. | 3.50 | 3.50 | 3.50 | 3.50 |
| Jan. | 3.50 | 3.50 | 3.50 | 3.50 |
| Feb. | 3.50 | 3.50 | 3.50 | 3.50 |
| Mar. | 3.50 | 3.50 | 3.50 | 3.50 |
| Apr. | 3.50 | 3.50 | 3.50 | 3.50 |
| May | 3.50 | 3.50 | 3.50 | 3.50 |
| June | 3.50 | 3.50 | 3.50 | 3.50 |
| July | 3.50 | 3.50 | 3.50 | 3.50 |
| Aug. | 3.50 | 3.50 | 3.50 | 3.50 |
| Sep. | 3.50 | 3.50 | 3.50 | 3.50 |
| Oct. | 3.50 | 3.50 | 3.50 | 3.50 |
| Nov. | 3.50 | 3.50 | 3.50 | 3.50 |
| Dec. | 3.50 | 3.50 | 3.50 | 3.50 |
| Jan. | 3.50 | 3.50 | 3.50 | 3.50 |
| Feb. | 3.50 | 3.50 | 3.50 | 3.50 |
| Mar. | 3.50 | 3.50 | 3.50 | 3.50 |
| Apr. | 3.50 | 3.50 | 3.50 | 3.50 |
| May | 3.50 | 3.50 | 3.50 | 3.50 |
| June | 3.50 | 3.50 | 3.50 | 3.50 |
| July | 3.50 | 3.50 | 3.50 | 3.50 |
| Aug. | 3.50 | 3.50 | 3.50 | 3.50 |
| Sep. | 3.50 | 3.50 | 3.50 | 3.50 |
| Oct. | 3.50 | 3.50 | 3.50 | 3.50 |
| Nov. | 3.50 | 3.50 | 3.50 | 3.50 |
| Dec. | 3.50 | 3.50 | 3.50 | 3.50 |
| Jan. | 3.50 | 3.50 | 3.50 | 3.50 |
| Feb. | 3.50 | 3.50 | 3.50 | 3.50 |
| Mar. | 3.50 | 3.50 | 3.50 | 3.50 |
| Apr. | 3.50 | 3.50 | 3.50 | 3.50 |
| May | 3.50 | 3.50 | 3.50 | 3.50 |
| June | 3.50 | 3.50 | 3.50 | 3.50 |
| July | 3.50 | 3.50 | 3.50 | 3.50 |
| Aug. | 3.50 | 3.50 | 3.50 | 3.50 |
| Sep. | 3.50 | 3.50 | 3.50 | 3.50 |
| Oct. | 3.50 | 3.50 | | |

Selected offers-Real estate-Rentals

017-558

Guaranteed Ads mean...

FAST MONEY

Call Today 733-0626

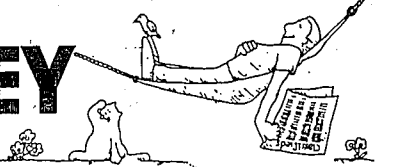

3 LINES, 7 DAYS, \$1050

If You Don't Sell, Either Don't Pay For Ad or Run A Second Week For Free.

PRIVATE PARTY RATE CHART table with columns for word equivalent lines and consecutive insertions.

ASK ABOUT OUR SPECIALS! BOX CHARGE: \$4.00 Mailed \$3.00 PICKUP-MEMORIAL ADS \$5.00 Per Day

CHUCK YOUR AD ON THE FIRST PUBLICATION Please check your ad on the first day of publication.

DEADLINE: Classified Ads for Tuesday through Saturday - 6:00 p.m. day preceding publication.

022-Buhl-Filer Homes: FILER: nice 2 bdrm, 24x24 ft. fenced back yard, 139,500. 372-5049/415.

033-Kimberly-Hansen: BY OWNER: 3 bdrm, 1 bath, garage, fenced back yard, wood stove, 309 Tamarc, Kimberly, Call 734-6251.

034-Jerome Homes: FILER: 1970 Fleetwood 3 bdrms, 1 1/2 baths, country tile, 326-5265 after 5PM.

035-Gooding/Wendell: WENDELL, 3 bedroom, completely remodeled, new tile, built-in kitchen, etc.

036-Acragoa & L's: CHOICE VIEW N. E. by Falls Ave. Excellent blocktop roads.

037-Farms & Ranches: FOR SALE OR TRADE: 300 acres, 1/2 mile from town.

045-Mobile Homes: 12x30 Fleetwood, Early American, swamp cooler, Air Conditioning, 219 S. 324-8668.

050-Furnished Houses: HAZELTON: nice 2 bdrm home, newly re-decorated, carpet, appliances, Call 413-302-5150.

051-Urban Houses: A BUHL, 3 bdrm, 2 bath home on 1/2 acre with garage, call 734-5550.

052-Furn. Apt. & Dupl.: 1 bdrm, \$180, 2 bdrm, \$175, 3 bdrm, \$210.

053-Business Property: Black Bear Tavern 3 miles west of Buhl, good location.

054-Urban Apts. & Duplexes: A CLEAN, 2 bdrm apt, water, electric, 1715 S. 324-7070.

054-Urban Apts. & Duplexes: In Filer, 1 bdrm apt, stove, refrigerator, utilities paid, except elec. \$175/mo.

054-Urban Apts. & Duplexes: Quiet, Luxury 1 & 2 Bedroom Apartments Center City, 324-7400.

054-Urban Apts. & Duplexes: LAUREL PARK APTS 170 Main St., North 734-4195.

054-Urban Apts. & Duplexes: FREE CABLE NOW! at Northwest Manor, 1, 1 bdrm, stove & refrigerator.

054-Urban Apts. & Duplexes: 1 bdrm, \$180, 2 bdrm, \$175, 3 bdrm, \$210.

054-Urban Apts. & Duplexes: GOOD AREA TF, very nice, 2 bdrm, 1 bath, fireplace, AC, some appl, garage.

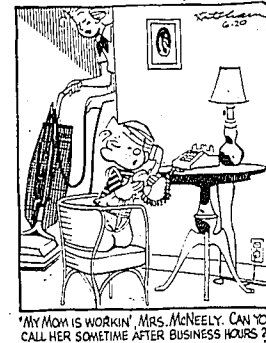

017-BUSINESS AND ELEVATOR COMPANY: Two Fall Creek businesses for sale on 100 Canyon Street.

018-Income Property: 16-unit apt bldg plus house on 1000 sq ft lot.

022-Investment: Buy, Sell or Broker: ROADS, TRAILS, MORTGAGES & DEEDS OF TRUST.

025-Instruction: PROFESSIONAL FLORAL DESIGN SCHOOL: Low cost course, National School of Floral Design.

030-Homes For Sale: 030-Homes For Sale: 030-Homes For Sale: 030-Homes For Sale.

030-Homes For Sale: GIVEWALT A CALL to learn more on this \$19,500 2 bdrm home that would make an excellent starter or rental property.

G.S.R.: GEM STATE REALTY 734-0400. ORTOLL FREE 1-800-425-9518/829.

030-Homes For Sale: HILLCREST LANE is the BEST LOCATION in town and the lovely 4 bdrm to 5 bdrm home.

030-Homes For Sale: HAMLETT REALTY OFFICE: 733-0779. Dave Hamlett, 733-4030.

030-Homes For Sale: MOTIVATED SELLER wants to move this 3 bdrm home. Farm home, assumption possible.

030-Homes For Sale: 030-Homes For Sale: 030-Homes For Sale: 030-Homes For Sale.

030-Homes For Sale: 030-Homes For Sale: 030-Homes For Sale: 030-Homes For Sale.

030-Homes For Sale: 030-Homes For Sale: 030-Homes For Sale: 030-Homes For Sale.

030-Homes For Sale: 030-Homes For Sale: 030-Homes For Sale: 030-Homes For Sale.

030-Homes For Sale: 030-Homes For Sale: 030-Homes For Sale: 030-Homes For Sale.

030-Homes For Sale: 030-Homes For Sale: 030-Homes For Sale: 030-Homes For Sale.

030-Homes For Sale: 030-Homes For Sale: 030-Homes For Sale: 030-Homes For Sale.

030-Homes For Sale: 030-Homes For Sale: 030-Homes For Sale: 030-Homes For Sale.

030-Homes For Sale: 030-Homes For Sale: 030-Homes For Sale: 030-Homes For Sale.

030-Homes For Sale: 030-Homes For Sale: 030-Homes For Sale: 030-Homes For Sale.

030-Homes For Sale: 030-Homes For Sale: 030-Homes For Sale: 030-Homes For Sale.

030-Homes For Sale: 030-Homes For Sale: 030-Homes For Sale: 030-Homes For Sale.

030-Homes For Sale: 030-Homes For Sale: 030-Homes For Sale: 030-Homes For Sale.

030-Homes For Sale: 030-Homes For Sale: 030-Homes For Sale: 030-Homes For Sale.

030-Homes For Sale: 030-Homes For Sale: 030-Homes For Sale: 030-Homes For Sale.

030-Homes For Sale: 030-Homes For Sale: 030-Homes For Sale: 030-Homes For Sale.

030-Homes For Sale: 030-Homes For Sale: 030-Homes For Sale: 030-Homes For Sale.

030-Homes For Sale: 030-Homes For Sale: 030-Homes For Sale: 030-Homes For Sale.

030-Homes For Sale: 030-Homes For Sale: 030-Homes For Sale: 030-Homes For Sale.

030-Homes For Sale: 030-Homes For Sale: 030-Homes For Sale: 030-Homes For Sale.

030-Homes For Sale: 030-Homes For Sale: 030-Homes For Sale: 030-Homes For Sale.

030-Homes For Sale: 030-Homes For Sale: 030-Homes For Sale: 030-Homes For Sale.

030-Homes For Sale: 030-Homes For Sale: 030-Homes For Sale: 030-Homes For Sale.

030-Homes For Sale: 030-Homes For Sale: 030-Homes For Sale: 030-Homes For Sale.

030-Homes For Sale: 030-Homes For Sale: 030-Homes For Sale: 030-Homes For Sale.

030-Homes For Sale: 030-Homes For Sale: 030-Homes For Sale: 030-Homes For Sale.

030-Homes For Sale: 030-Homes For Sale: 030-Homes For Sale: 030-Homes For Sale.

030-Homes For Sale: 030-Homes For Sale: 030-Homes For Sale: 030-Homes For Sale.

030-Homes For Sale: 030-Homes For Sale: 030-Homes For Sale: 030-Homes For Sale.

030-Homes For Sale: 030-Homes For Sale: 030-Homes For Sale: 030-Homes For Sale.

030-Homes For Sale: 030-Homes For Sale: 030-Homes For Sale: 030-Homes For Sale.

030-Homes For Sale: 030-Homes For Sale: 030-Homes For Sale: 030-Homes For Sale.

030-Homes For Sale: 030-Homes For Sale: 030-Homes For Sale: 030-Homes For Sale.

030-Homes For Sale: 030-Homes For Sale: 030-Homes For Sale: 030-Homes For Sale.

030-Homes For Sale: 030-Homes For Sale: 030-Homes For Sale: 030-Homes For Sale.

AFFORDABLE NEW LISTINGS

- 4 BEDROOM BRICK, quick cut-dac-stucco, nice fenced yard, new roof, full basement, 2 fireplaces & double garage. \$54,900.
CUTE ONE BEDROOM HOME. Great starter home or rental. Detached garage. Young adults will love this one \$23,500.
EXCLUSIVE MOUNTAIN & water landscaping. Part unfinished basement. \$66,000.
BEDROOM family home in NE location. Full basement, woodburning stove, eat in kitchen plus formal dining area. RV pad, double garage. \$72,500.
SUN VALLEY STYLING with huge living room & massive live oak fireplace. Private lot with detached back yard, garden & stone rock & fruit trees. You will love this 3 bdrm, 2 1/2 bath home. \$74,500.
ALMOST 1400 SQ. Ft. Nicely maintained young family home in good location. Large 8 1/2 x 5 ft. pool. Ready to occupy. \$41,500.
ESPECIALLY NICE 3 bedroom. 2 bath condo located in quiet residential neighborhood. 1200 sq. ft., air conditioned comfort. You will never buy more for \$52,800.
BRICK DUPLEX in Kimberly. Carpets & full basements. Excellent rental history. Owner will consider all reasonable offers. \$52,000.
NICE HOME in FILER close to elementary school, 3 bedroom, single garage, woodburning stove, nicely decorated. Deep lot and nice yard. \$31,500.

IRWIN REALTY INC. 1201 Falls Ave. E. 734-6500

AFFORDABLE NEW LISTINGS

- 4 BEDROOM BRICK, quick cut-dac-stucco, nice fenced yard, new roof, full basement, 2 fireplaces & double garage. \$54,900.
CUTE ONE BEDROOM HOME. Great starter home or rental. Detached garage. Young adults will love this one \$23,500.
EXCLUSIVE MOUNTAIN & water landscaping. Part unfinished basement. \$66,000.
BEDROOM family home in NE location. Full basement, woodburning stove, eat in kitchen plus formal dining area. RV pad, double garage. \$72,500.
SUN VALLEY STYLING with huge living room & massive live oak fireplace. Private lot with detached back yard, garden & stone rock & fruit trees. You will love this 3 bdrm, 2 1/2 bath home. \$74,500.
ALMOST 1400 SQ. Ft. Nicely maintained young family home in good location. Large 8 1/2 x 5 ft. pool. Ready to occupy. \$41,500.
ESPECIALLY NICE 3 bedroom. 2 bath condo located in quiet residential neighborhood. 1200 sq. ft., air conditioned comfort. You will never buy more for \$52,800.
BRICK DUPLEX in Kimberly. Carpets & full basements. Excellent rental history. Owner will consider all reasonable offers. \$52,000.
NICE HOME in FILER close to elementary school, 3 bedroom, single garage, woodburning stove, nicely decorated. Deep lot and nice yard. \$31,500.

IRWIN REALTY INC. 1201 Falls Ave. E. 734-6500

AFFORDABLE NEW LISTINGS

- 4 BEDROOM BRICK, quick cut-dac-stucco, nice fenced yard, new roof, full basement, 2 fireplaces & double garage. \$54,900.
CUTE ONE BEDROOM HOME. Great starter home or rental. Detached garage. Young adults will love this one \$23,500.
EXCLUSIVE MOUNTAIN & water landscaping. Part unfinished basement. \$66,000.
BEDROOM family home in NE location. Full basement, woodburning stove, eat in kitchen plus formal dining area. RV pad, double garage. \$72,500.
SUN VALLEY STYLING with huge living room & massive live oak fireplace. Private lot with detached back yard, garden & stone rock & fruit trees. You will love this 3 bdrm, 2 1/2 bath home. \$74,500.
ALMOST 1400 SQ. Ft. Nicely maintained young family home in good location. Large 8 1/2 x 5 ft. pool. Ready to occupy. \$41,500.
ESPECIALLY NICE 3 bedroom. 2 bath condo located in quiet residential neighborhood. 1200 sq. ft., air conditioned comfort. You will never buy more for \$52,800.
BRICK DUPLEX in Kimberly. Carpets & full basements. Excellent rental history. Owner will consider all reasonable offers. \$52,000.
NICE HOME in FILER close to elementary school, 3 bedroom, single garage, woodburning stove, nicely decorated. Deep lot and nice yard. \$31,500.

IRWIN REALTY INC. 1201 Falls Ave. E. 734-6500



MOUNTAIN VIEW APARTMENTS Effective June 1st 1 Bedroom As Low As \$175 2 Bedroom As Low As \$195 Includes: Air conditioning & Playground Laundry Facilities

Jackpot, Nevada 702-755-2537

058-083

Rentals-Merchandise-Merchandise

Isn't it time you had a GARAGE SALE?

Make Your Garage Sale A Success! Get 2 Free Garage Sale Signs When You Pay For Your Classified Ad

5 LINES 2 DAYS \$7.00 CALL CLASSIFIED TODAY 733-0931

The Times-News

- 058-Office and Business Rental
059-Condominiums For Rent
060-Warehouse/Storage/Rentals
061-Miscellaneous
062-Miscellaneous
063-Miscellaneous
064-Miscellaneous
065-Miscellaneous
066-Miscellaneous
067-Miscellaneous
068-Miscellaneous
069-Miscellaneous
070-Miscellaneous
071-Miscellaneous
072-Miscellaneous
073-Miscellaneous
074-Miscellaneous
075-Miscellaneous
076-Miscellaneous
077-Miscellaneous
078-Furn. & Carpets
079-Appliances

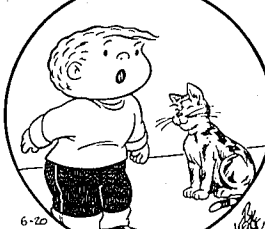

Our New Direct Lines Make Classified A REAL LIVE WIRE!!



You have a real live wire in your life! And you can use it in so many ways to make life simpler. You can use it to place a fast-acting Classified Ad to sell items you no longer need around your home. And then sit back and see how that mighty little ad turns your telephone into a REAL LIVE WIRE! Turn those no longer needed items into fast cash and your telephone into a live wire today! Our NEW DIRECT Phone Number is 733-0626

We'll be waiting for your call

NOW... PHONE CLASSIFIED DIRECT

733-0626

The Times-News

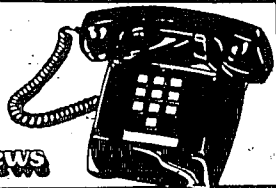

135-Cycles & Supplies

1978 Honda CM400T, wind-shield, low miles, clean, \$600. Call 324-0807 even.

135-Cycles & Supplies

81 Honda Odyssey good condition. Call 323-5061.

139-Pick-Up Trucks

1985 Ford V-8 ton PU camper special. Saddle tanks. AC, good condition. Call 324-3076.

139-Pick-Up Trucks

1981 Datsun King cab PU, diesel, AC, 22,000 miles, exc. condition. \$2600. Phone 878-5328 or 878-7414.

140-Heavy Trucks/Semil's

1985 Chevrolet 510 PU, long body with camper shell, \$3500. Call 733-5859.

142-Import Sports Cars

1978 Honda Accord LX, 5 sp, AC, FM cassette, good condition. \$3300. Call 324-1313.

146-4 Wheel Drives

1974 Ford 1/2 ton 4x4, custom loaded and interior, two tone paint, good motor and transmission, dual shocks and steering stabilizers. AM/FM cassette. \$2815. Ground Haver, \$500. Been in storage. Call Teri, 733-8405.

U.S. GOVERNMENT VEHICLE SALE 86 VEHICLES... VANS, 4-WHEEL DRIVE PICKUPS, SEDANS, STATION WAGONS, UTILITY AND UTILITY MAINTENANCE TRUCKS, CAB AND CHASSIS: A 47,000 GVW TRACTOR, A 40-FOOT BAY TRAILER AND A SNOW BLOWER.

135-Cycles & Supplies

1983 Kawasaki KDX 200, dirt bike, superior condition, \$1500. Call 524-8453.

139-Pick-Up Trucks

2 long wide pickup boxes, 1978 Dodge, and 1976 Chevy, 1978 Dodge cab, \$45414 Ram-530pm. McPh, J&L Wheel Alignment.

140-Heavy Trucks/Semil's

1978 Ford XLT F-250 super cab truck. Chrome plated wheels, 3.5000 lim, disc brakes, all the options, great looking and running, must see to appreciate. \$3500. Call 733-2488.

142-Import Sports Cars

BUDGET RENT A CAR 1985 Nissan 300ZX, 4 door, loaded, approximately 27,000 miles.

146-4 Wheel Drives

CLEAN, sharp, 1975 Chevy heavy 1/2 ton. New paint, trans and tires. \$2795. Best offer. Call 733-8230.

146-4 Wheel Drives

1978 Dodge Ram 50, 4 wheel drive pickup, only 1,000 miles. \$795. 733-4939.

DRIVE A 1986 PLYMOUTH ONLY \$204.72 Per Mo. 1986 PLYMOUTH RELIANT STATION WAGON Stock #632120. 2.5 liter electronically fuel injected engine, automatic transmission, rear defrost, luggage rack, cruise control, white side wall tires, luxury wheel covers, tinted glass, power steering, AM/FM stereo radio, rear wiper/washer and much more.

SERVICE GUIDE AND DIRECTORY

ADVERTISE YOUR SERVICE SPECIALTY IN THIS DIRECTORY

Placed under the heading of your choice. Your ad will reach 22,000 families everyday and this today will amaze you. Call today and one of our friendly Ad-Visors will help you word your ad so that it will be most effective and bring you the results you are looking for.

733-0931

Need a spring tonic for your household budget? Sell your "don't need" in classified. Call 733-5631

CARPENTRY DECKS, fences & all home & yard improvements. Free estimates. Westley 734-1158.

Remodeling, repair & painting. Free estimates. 15 yrs. experience. Phil, 423-4353.

SHEDS BUILDING CUSTOM HAYSTACKING 2 wide, will travel. Call 423-0524.

CUSTOM HAY STACKING Black or regular stacks. Call 535-2273.

FARMERS! Custom haying, swathing, baling & stacking. Call 423-5220 or 423-1655.

GRAVEL SAND TOPSOIL Delivered for driveways, parking lots, etc. Can haul too. Call Northwest Crane & Rigging, 733-1234.

Schuyler Trucking will take care of all your long and drive way repairs. 324-2243.

LANDSCAPING Sitos Lawn Sprinkler Sys. recovers, auto-matic repairs. 734-2328, 733-0081.

Residential & commercial lawn care & cleanup. FREE estimates. Valley Lawn Care 733-0257/734-0544 even.

YOU CALL WE HAUL. 1 ton truck & 2 chainsaws. Brush, branches, junk, etc. Also, pickup & deliver. Free estimates. EZ rates. Call Dave or Bob at 733-8629.

Cleaning, hauling, grading, shrub removal, spraying. Free est. Tony 734-3222.

LAWN SERVICE MAINTENANCE Most complete home & garden service. Includes: carpentry, concrete, landscaping, mowing, cleanup, hauling. After 7pm 733-8730.

Lawnmower tune-up & repair, free pickup & deliver. Used mowers, \$35 up. Homelite XL chainsaw, \$100, lake trades, 733-3335.

BAD Yard Care. Mow, trim, seasonal maintenance. Free estimates. 734-4361.

Yard Cleaning-Trimming Expert & reasonably priced. Chris Jeppesen. Call 733-7379.

PAINTING PAPERING DICK'S PAINTING 30 years exp. Residential, comm., interior/exterior, ref. 734-7218.

BRANSON'S PAINTING, quality supreme, but prices affordable. Free estimates and evaluations. 733-0422.

Painting and paper hanging. Excellent work, reasonable rates, references. 733-4063.

Residential or commercial, interior & exterior, reasonable, free estimates. J & K Painting, 733-7521.

PLUMBING Complete Plumbing Installing & Repairs. 24 hrs. McCuire Plumbing, 733-4766.

REMODELING Patios, garages, homes, sidewalks, roofing, and cabinets. 733-9567/734-0566.

Home repairs. Shastrock to cement. Concrete, plumbing & painting. 734-8634.

L.P. Roofing & Remodeling, roofing, general carpentry, free estimates, work guaranteed. 15 years experience. Call 734-9514 or 423-4034.

ROTOILLING Garden and lot reroiling. Arnold Mow. Call 733-5782.

TREE SERVICE Tree & shrubbery trimming, free estimates. Invoiced. Jim's Tree Care, 734-1454.

Tree trimming & shrub work. Master Tree & Yard Care. Free est. 734-1326.

Tree & shrub topping & removal. Free estimates. 733-9539, 734-4365.

Mobile Service. Discounts Rates. Reliable. CRACK & CHIP, 734-0064.

175-Auto Dealers

175-Auto Dealers

175-Auto Dealers

175-Auto Dealers

175-Auto Dealers

175-Auto Dealers

175-Auto Dealers

175-Auto Dealers

175-Auto Dealers

175-Auto Dealers

175-Auto Dealers

175-Auto Dealers

175-Auto Dealers

175-Auto Dealers

175-Auto Dealers

175-Auto Dealers

175-Auto Dealers

175-Auto Dealers

175-Auto Dealers

175-Auto Dealers

175-Auto Dealers

175-Auto Dealers

175-Auto Dealers

175-Auto Dealers

175-Auto Dealers

175-Auto Dealers

175-Auto Dealers

175-Auto Dealers

175-Auto Dealers

175-Auto Dealers

175-Auto Dealers

175-Auto Dealers

175-Auto Dealers

175-Auto Dealers

175-Auto Dealers

175-Auto Dealers

175-Auto Dealers

175-Auto Dealers

175-Auto Dealers

175-Auto Dealers

175-Auto Dealers

175-Auto Dealers

175-Auto Dealers

175-Auto Dealers

175-Auto Dealers

175-Auto Dealers

175-Auto Dealers

175-Auto Dealers

175-Auto Dealers

175-Auto Dealers

175-Auto Dealers

175-Auto Dealers

175-Auto Dealers

175-Auto Dealers

175-Auto Dealers

175-Auto Dealers

175-Auto Dealers

175-Auto Dealers

175-Auto Dealers

175-Auto Dealers

THIS IS A BRIBE

At Randy Hansen we are offering 2 incredible deals. Deals that will allow you to get cars at the most unheard of, utterly ridiculous, absolutely, preposterous price around. It's the old carrot on the stick routine. By dangling the carrot in front of you, even if you are not already a Randy Hansen customer, you will have to come into our dealership to take advantage of these values.

YES - THIS IS A BRIBE

1986 CELEBRITIES Starting At \$10,999 #6-365. With air conditioning, V-6, automatic transmission, power steering & power brakes.

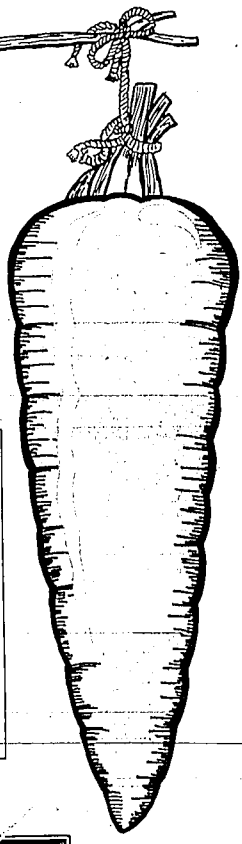

Randy Hansen Chevrolet In the Magic Valley 1654 Blue Lakes N. at Palmdale Rd. 733-3033

GM QUALITY SERVICE PARTS Mr. Goodwrench

146—Wheel Drives

1982 Ramcharger, AT, PS, PB, new tires, chrome wheels, exc. cond., reduced to \$3500. Must call. 734-2287 or 734-3572.

1982 Suburban, exc. cond. clean, wheel drive, all power, \$8000. Call 732-4681.

1984 Bronco 19V, 4 spd, PS, PB, cab, roof rack, 10,000 miles. Call 733-0903.

1984 Chevy K-10, 4 x 4, Scottsdale, AT, PS, PB, hill cruise, AM/FM, 305 V-8, Must Sell! Call 788-3500.

1985 CHEVY 4x4 Silverado, dual tanks, AC, HI, cruise, shap, Call 678-0321.

1985 Ford Ranger XL, 4 x 4, loaded, excellent condition. Call 678-7668 or 678-0788.

1985 GMC 4x4 extended cab pickup, High Sierra package, all the extras. 324-5177 After 5:00 p.m.

79 Chevy Silverado P44 x 4, loaded, must see, \$4800. Call 837-6679.

90 Jeep G5, metallic green, 4 spd, 8 cyl, dual exhaust, two tops, \$4100. 328-4228 or 328-4312.

85 Bronco II, 2 tone paint, V-8, AC, AT, cruise, AM/FM, 115,900 mi., asking \$11,800. 733-1823. TALK-2FM.

156—Autos - Chrysler

1985 Chrysler Le Baron, Call Larry or Patty at Dollins, 423-1111 or 423-5630.

158—Autos - Chevrolet

BUDGET RENT A CAR
1985 Chevy Caprice Classic, 4 door, AC, AT, PS, PB, hill cruise, rear defrost, wire wheel covers, 25,000 miles, \$9,295.

Call Roger 383-3000 or 456-8314 after 6.

MINT COND. 1974 Monte Carlo, very low miles, exc. condition, clean, 734-3594 or can be seen at 432 Mead. ows Lane, Twin Falls Spm.

1984 Chevy Impala Interceptor, sun roof, stereo, tires & wheels, all new, 423-0104.

1985 CHEVILLE
Good body, fair motor, \$600. Call 733-5387.

1990 Citation, 4 sp, new tires, cruise control, \$2000. Call 734-4622.

1985 Chevy Cavalier, 4 dr, red, \$1000 down, take over the payment, down negotiable. 734-6443 or 733-0855.

158—Autos - Chevrolet

1988 CAMARO Rally Sport, 327 4 speed, \$1250; 1973 Camo Rally Sport, red on red, AC, PS, PB, PW, 350 AT, \$7500; 1984 Corvette coupe, 327 AT, PS, PW, all numbers match, \$11,500. Call days 678-9556 Anderson Tunup, or 678-1456 overnights.

166—Mercury & Lincoln

VERY CLEAN, 1989 Cougar. New paint, engine, trans, wheels. Many extras. Call 733-6844 eves.

1981 Capri, 1 owner, 42,000 mi., 8 cyl, AT, AM/FM, exc. condition. \$3995. See at Valley Schwinn or call 733-8384 or 733-0871.

88 Zephyr Signa, AC, PB, PS, AM/FM, low miles, \$1825. 423-5384 after 3pm.

Pending the purchase of a cell check out classified, Call 733-0331.

168—Autos - Oldsmobile

BUDGET RENT A CAR
1985 OLDS Firenza, 4 door, AC, AT, PS, PB, hill, AM/FM, 29,000 miles, \$6,395. Call Roger 383-3000 or 456-8314 after 6.

1986 OLDS 86, 4 door, runs good, 4493 miles offer. 1228 Wilmore or call 734-4492.

1981 Olds Cutlass Supreme diesel, 2 dr, AC, PS, PB, cruise, AM/FM cassette, exc. condition, \$3500. Call 536-8470 after 5.

172—Autos - Pontiac

1973 Pontiac Grand AM, runs real good, good tires, must sell, \$600 offer. Days, 543-8648, Pignonei Fissora, or Bob, 543-8644 or 543-8553.

1977 FIREBIRD, 350-V8, 4 barrel, loaded, AC, AT, PS, PB, cruise, low tires & brakes, \$2500 firm! 733-3733.

1977 Firebird, radials, contour line wheels, 300 Goodbook & headers, call 678-0831.

1980 Phoenix LJ, V-6, AC, PS, 4sp, great motor, low miles, \$2750. Call 733-5787.

173—Autos - Plymouth

1969 Road Runner, 2 owner, 354 sp, 47,000 mi, \$2,250. Days, 678-9556, Anderson Tunup, or 678-1456 overnights.

1976 Plymouth 8 passenger Station Wagon, \$975 or best offer. Call 326-5852.

1976 Valair wagon, 6 cylinder, AC, runs good, \$725. After 7pm, 324-8233.

78 Plymouth Sapporo, runs good, exc. condition, \$1800.

733-9274 Hanson's cleaning days; over 734-8818.

175—Auto Dealers

175—Auto Dealers

175—Auto Dealers

175—Auto Dealers

175—Auto Dealers

175—Auto Dealers

YEAR-END CLEARANCE 1986 YEAR-END COUNTDOWN
JUST RECEIVED OUR LAST SHIPMENT OF NEW 1986'S
MODELS OVER 21 UNITS BRINGS TOTAL TO 53 UNITS AVAILABLE FOR IMMEDIATE DELIVERY
ALL PRICES SLASHED
(14) NEW 1986 OLDSMOBILE DELTA 88'S, BUICK LOSABRES, 2 DOORS & 4 DOORS, 2 CHEVY CAPRICE CLASSICS
AS LOW AS \$13,326
(9) NEW '86 PONTIAC 6000 OLDS, CIERRAS, BUICK CENTURYS & CHEVROLET CELEBRITIES
AS LOW AS \$10,341
(5) NEW 1986 BUICK SKYLARKS, OLDS CALAIS, PONTIAC GRAND AM
AS LOW AS \$10,588
(4) CHEVROLET CAVALIERS & PONTIAC SUNBIRDS
AS LOW AS \$8890
(5) NEW 1986 CHEVROLET NOVAS, 6PECTRUMS & SPRINTS
AS LOW AS \$6232
AT SUPER SAVINGS
(4) CHEVROLET ASTRO VANS
(2) CHEVROLET SUBURBANS
(12) 5-10 BLAZERS & 10 PICKUPS
(9) CHEVROLET 7/8 TON & 1/2 TON PICKUPS - 2 WHEEL & 4 WHEEL DRIVES

SUPER DUPE SAVINGS ON 1985 & 1986 DRIVER TRAINING & DEMONSTRATORS
Pontiac Sunbirds, Chevrolet Cavalier, Chevrolet Nova

5.9% FINANCING
OAC Selected Models and Terms
Also leasing is available.

LEO RICE MOTOR CO., INC.
CHEVROLET — PONTIAC — OLDSMOBILE — BUICK
934-4439 GOODING 934-4438



NO MONEY DOWN

and payments start as low as **\$136⁵³**

for a German Engineered Golf with no money down!

OR

a German Engineered Jetta and payments start as low as **\$147³⁰**

with no money down!

OR

A German Engineered Scirocco with no money down and payments start as low as **\$183⁴⁹**

Plus Tax

CHRIS JORDAN
Volkswagen Porsche/Audi
"We Aim To Please"
1634 Blue Lakes Blvd. North
Twin Falls, Idaho 83301
733-2954

148—Antique Autos

SHOW CAR, 1966 LeMans coupe, built from the ground up. Setups, local flea only. Call 733-4906.

1948 GMC 2 ton, exc cond, 4 spd, 8 cyl, dual exhaust, two tops, \$4100. 328-4228 or 328-4312.

85 Bronco II, 2 tone paint, V-8, AC, AT, cruise, AM/FM, 115,900 mi., asking \$11,800. 733-1823. TALK-2FM.



NEW TRUCKS & CARS ARRIVING WEEKLY

NEW MAZDA SE-5 Plus 5

FOR A LIMITED TIME ONLY, A SPORTY TRUCK VALUE NOW GETS \$625 WORTH OF EXTRAS AT NO EXTRA CHARGE!

SE-5 is loaded to start with: 5-Speed • Step Bumper • Spoker Wheels • White-Letter Steel Radials • And more. NOW ADD: Bed Liner • Mud Guards • Sliding Rear Window • Floor Mats • AM/FM Stereo • ALL AT NO EXTRA CHARGE TO YOU! **\$6795***

*Includes dealer prep, options, freight charges, Taxes, license extra.

Carpenters IMPORTS
"Magic Valley's Finest Truck Dealer"
200 W. Main Street, Twin Falls, Idaho 83301

149—Autos - AMC

1980 AMC Concord, 25,000 miles, economical, AC, all season radials, exc cond & appearance, 837-8635.

151—Autos - Buick

1981 BUICK Le Sabre, 4 door hardtop, PS, PB, AT, new paint, sell or trade for your convertible, 734-5879 after 6pm or weekends.

1988 Buick LeSabre, new tires, no oil, new maintenance. Exc student car, \$500! best offer. 429-5538, days.

1973 Buick Centurion, good condition, new paint, \$509. Call 543-5760.

1975 Riviera, excellent running cond, immaculate interior. Must sell! 733-8234.

154—Autos - Cadillac

Cadillac deville, 1984 white classic, all original, collectors dream, \$1500. Call 734-0628 or 733-8400.

175—Auto Dealers

ROY RAYMOND FORD/BMW

SAVE \$2000.00

1986 THUNDERBIRD



Sale Monday, June 23rd

Factory Discount \$626
Roy Raymond Discount \$1374
TOTAL \$2000.00

- 3.8 L V-6 EFI engine
- Interval windshield wipers
- Automatic overdrive transmission
- Illuminated entry system
- Electronic digital clock
- Tilt steering wheel
- Leather-wrapped steering wheel
- Speed control
- 6-way power driver's seat
- Rear window defroster
- Air conditioner
- Electronic AM/FM stereo with cassette
- Dual electric remote mirrors
- Power side windows
- Locking wire-style wheel covers
- Tinted glass
- Light group
- Power lock group
- SB radial whitewalls
- Bodyside moldings
- Dual paint stripes

MANY MORE TO CHOOSE FROM AT SIMILAR SAVINGS

733-5110  **ROY RAYMOND**  **733-5110**

CUSTOMER SERVICE IS OUR DRIVING CONCERN

1243 Blue Lakes Blvd., N., Twin Falls, Idaho • (208) 733-5110

ROY RAYMOND FORD/BMW
Special Prices For The First Week of Summer WEEKEND SPECIALS

| | | |
|---|---|---|
| 1976 TOYOTA COROLLA #3791 Was \$1995 NOW \$987 | 1978 MERCURY COUGAR 4 DOOR #3753 Was \$2995 NOW \$1487 | 1973 CHEVROLET 1 TON FLATBED #4876 Was \$2995 NOW \$1287 |
| 1972 CHEVROLET BLAZER #4874 Was \$3295 NOW \$1387 | 1978 DODGE ASPEN WAGON #3783 Was \$2995 NOW \$1987 | 1980 BUICK REGAL 2 DOOR #3773 Was \$3995 NOW \$2487 |
| 1978 OLDSMOBILE CUTLASS SUPREME #3739 Was \$3995 NOW \$2487 | 1980 MAZDA WITH SHELL #4867 Was \$3995 NOW \$2487 | 1982 FORD F250 #4871 Was \$3995 NOW \$2787 |
| 1981 FORD F250 4X4 #4870 Was \$3995 NOW \$2987 | 1978 DATSUN 280Z 2+2 #3792 Was \$4995 NOW \$3987 | 1983 PONTIAC BONNEVILLE WAGON #3781 Was \$6995 NOW \$5887 |
| 1984 FORD F150 #4866 Was \$7495 NOW \$6287 | 1984 JEEP C17 Only 9,000 Miles. #4879 Was \$8995 NOW \$7887 | REGISTER TO WIN A FREE VCR TO BE GIVEN AWAY JULY 1st |

733-5110  **ROY RAYMOND**  **733-5110**

CUSTOMER SERVICE IS OUR DRIVING CONCERN

1243 Blue Lakes Blvd., N., Twin Falls, Idaho • (208) 733-5110

ROLLING STOCK ROUNDUP

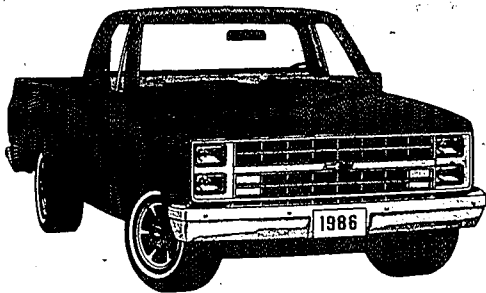

1986 CHEVROLET 1/2 TON PICKUP

#T3219. Mirrors, power brakes, V-8 engine, automatic transmission, auxiliary fuel tank, power steering, AM radio, rear step bumper, exterior decor package, gauges, much, much more! Retail Value \$12,831.00.

NOW \$10,895⁰⁰

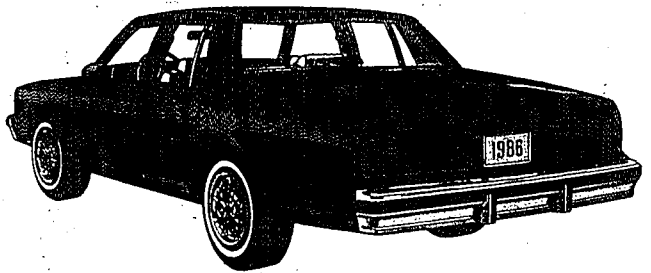

1986 CAPRICE 4 DOOR

#2942. Power door locks, air conditioning, cruise control, automatic transmission, tilt wheel, AM/FM stereo, and much, much more! Retail Value \$13,495.00.

NOW \$10,995⁰⁰

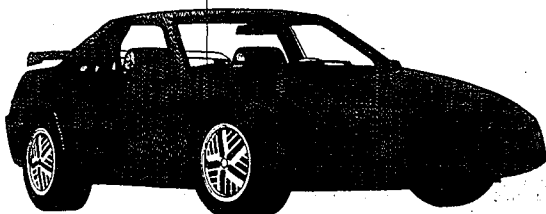

1986 FIERO 'GT'

#P228. Removable sun roof, European suede bucket seats, rear window defogger, air conditioning, cruise control, automatic transmission, and much more! Retail Value \$16,354.00.

NOW \$15,195⁰⁰



1986 CAMARO Z28 IROC

#2924. Custom interior, power hatch release, mats, removable glass roof panels, air conditioning, cruise control, tilt wheel, and much, much more! Retail Value \$17,218.00.

NOW \$14,695⁰⁰



1986 PONTIAC PARISIENNE

#P192. Power seats, power door locks, power windows, rear window defogger, air conditioning, custom tu-tone, cruise, tilt wheel, cast aluminum wheels, AM/FM stereo system, and much more! Retail Value \$17,741.00.

NOW \$14,995⁰⁰

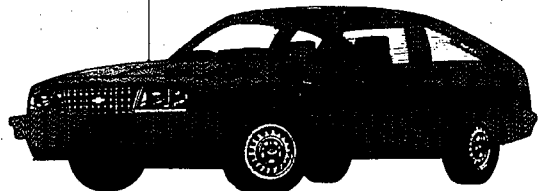

1986 CAVALIER 2 DOOR HATCHBACK

#2967. Air conditioning, sport mirrors, automatic transmission, tinted glass, power steering, wheel trim rings, all season steel belted radials, electronically tuned AM/FM stereo, and much more! Retail Value \$10,502.00.

NOW \$8,995⁰⁰

USED CARS

| | | | | | |
|---|----------------------------|---|---------------------------|-----------------------------------|---------------------------|
| 1986 CAPRICE #1173. Classic Brougham | NOW \$12,995 ⁰⁰ | 1984 OLDSMOBILE #1210. Cutlass 4 Door | NOW \$7,695 ⁰⁰ | 1977 CHEVROLET #1223. LUV | NOW \$2,495 ⁰⁰ |
| 1986 PONTIAC #1188. Grand AM | NOW \$9,995 ⁰⁰ | 1984 CHEVROLET #1212. Camaro Sport Coupe | NOW \$7,595 ⁰⁰ | 1980 PONTIAC #1225. Sunbird | NOW \$1,595 ⁰⁰ |
| 1985 SPRINT #1186 | NOW \$4,995 ⁰⁰ | 1983 CHEVROLET #1047. Citation | NOW \$4,495 ⁰⁰ | 1978 FORD #1161. Thunderbird | NOW \$2,895 ⁰⁰ |
| 1985 SUBARU #1193. Turbo 4x4 | NOW \$11,995 ⁰⁰ | 1984 CHEVROLET #1222. Chevette | NOW \$3,495 ⁰⁰ | 1975 DODGE #1215. Dart 2 Door | NOW \$995 ⁰⁰ |
| 1984 CHEVROLET #1196. Celebrity 4 Door | NOW \$6,995 ⁰⁰ | 1983 PONTIAC #1209. 6000 | NOW \$6,495 ⁰⁰ | 1978 CHEVROLET #1219. Chevette | NOW \$1,459 ⁰⁰ |
| 1985 HONDA #1205. Civic Wagon | NOW \$5,995 ⁰⁰ | 1981 MERCURY #1112. Cougar 2 Door | NOW \$3,995 ⁰⁰ | 1973 FORD #1983. Courier | NOW \$1,695 ⁰⁰ |

CON PAULOS CHEVROLET 

PONTIAC & GMC TRUCKS  

324-3900

901 S. Lincoln
Jerome

734-6565

\$99 DOWN WILL DELIVER ANY USED LYNX IN STOCK

1982 LYNX 3 DOOR
Bright red, sport stripes, high top, front wheel drive, deluxe interior.
Was \$3495 **\$2888**

1981 MERCURY LYNX
Dark ginger brown, sport stripes, stereo system, floor mounted transmission, front wheel drive.
Was \$3295 **\$2880**

1981 LYNX HATCHBACK
Red metallic, body side moldings, accent stripes, AM/FM stereo, front wheel drive.
Was \$3495 **\$2888**

1982 LYNX 3 DOOR
Blue in color, sport stripes, front wheel drive, floor mounted transmission.
Was \$3795 **\$3488**

1983 LYNX WAGON
Blue, AM/FM stereo, reclining seats, front wheel drive, floor mounted transmission.
Was \$4199 **\$3888**

1983 LYNX WAGON
Red, deluxe interior, AM/FM stereo cassette, front wheel drive, transmission, vacation ready.
Was \$4699 **\$3988**

1983 LYNX HATCHBACK
Automatic transmission, deluxe interior, AM/FM stereo radio, low miles, vacation ready.
Was \$4495 **\$3988**

1984 LYNX 3 DOOR
White, deluxe interior, radio, front wheel drive, reclining seats.
Was \$5295 **\$4688**

1985 LYNX 4 DOOR
Turquoise and metallic, steel belted radial tires, front wheel drive, looks new inside and out, low miles.
Was \$5995 **\$5488**

Emmett Harrison's THEISEN MOTORS
For Over 32 Years The Easiest Place In The World To Buy A Car
701 MAIN AVE. E. TWIN FALLS 733-7700

Theisen Motors' Service Specials LET US GET YOUR CAR VACATION READY

At Tremendous Savings! Air Conditioner Tune-Up

Includes: cleaning condenser fins, adjustment to drive belts, tightening of fittings and system check for leaks. Refrigerant and parts, and necessary installation labor extra, if needed. **\$9.95**

Honda Tune-up Special \$36.95

Let Merrill Lewis, our Honda specialist, tune-up your Honda

Front End Alignment Special \$14.95

Check and adjust caster, camber and toe-in. Passenger cars only. (Vehicles equipped with MacPherson strut suspensions include toe-in adjustment only.)

Because we sold you your Lynx... Lynx Tune-Up Special \$28.95

Solid state tune-up includes installation of Motorcraft spark plugs; inspection of choke, throttle linkage, spark plug wires and distributor cap; adjustment of idle and timing

PLUS FREE PLUS

We'll Check your anti-freeze, battery, belt, and entire cooling system so you won't have a worry on your vacation. Have a great vacation, let us check your car.

Call 733-7700 Today For Appointment

LOCALLY OWNED GRAND MARQUIS Sold New - Serviced Since

\$999 DOWN DELIVERS

1984 GRAND MARQUIS LS
Previously Owned by Mr. & Mrs. Len Kelly
Tune red, air conditioned, stereo sound system, rear window defogger, velour interior, power steering, power brakes, loaded.
WAS \$11,900 **\$10,580**

1985 GRAND MARQUIS
Previously Owned by Mrs. Elmer Cooch
4 DOOR. Absolutely like new, only 5,000 miles, dark brown metallic, white vinyl roof, all the power options.
NOW ONLY \$11,900

1984 GRAND MARQUIS
Previously Owned by Mr. Harley Halliburgh
4 DOOR. Beautiful silver, vinyl coach roof, gray dove velour interior, extremely low miles, power seats, power windows, absolutely loaded.
WAS \$11,950 **\$10,888**

1984 GRAND MARQUIS LS
Just off lease, automatic transmission, air conditioning, power steering, power brakes, tilt steering, cruise control, deluxe velour interior, stereo sound system, rear window defogger.
Was \$11,850 **\$10,450**

Emmett Harrison's THEISEN MOTORS
For Over 32 Years The Easiest Place In The World To Buy A Car
701 MAIN AVE. E. TWIN FALLS 733-7700

THEISEN MOTORS \$99 DOWN WILL DELIVER!

\$99 DOWN DELIVERS 1986 HONDA CIVIC 4 DOOR

No. H-211. Beautiful Silver gray, elec. rear window defogger, floor mounted 5 speed transmission, power brakes, ventilation system.
SAVE \$1000

WAS \$8859 **\$7858**

\$99 DOWN DELIVERS 1986 ACCORD DX 4 DOOR

No. H-191. Silver metallic, contrasting gray interior, power steering, radial tires, tinted glass, power brakes, intermittent wipers, 4 cylinder 12 valve engine.
SAVE \$1194

WAS \$10,682 **\$9488**

6.9% Available **28 To Choose From**

\$99.00 DOWN / \$117.15 per mo.

Sale price \$6288, \$99 down, 59 months, int. \$2797.05, APR 12.9, residual \$2075, total payments \$8968.05.

CHECK OUT THESE OPTIONS:

- Front wheel drive
- Overhead cam
- 4 spd. manual transxlu with overdrive 4th gear
- AM radio
- MacPherson strut front suspension
- Power front disc/rear drum brakes
- High mount stop lamp
- Inside hood release
- All season steel belted tires
- Single halogen aero headlights
- Color keyed console
- Black 4-spoke steering wheel with Mercury "M" badge
- Side window demisters
- Large grained glovebox with coin slots inside
- Deluxe interior

\$99 DOWN DELIVERS 1986 HONDA ACCORD LXI

No. H-202. The best Honda you can buy. Beautiful soft beige, luxury plus fuel efficiency, power moon roof, air, AM/FM stereo/cassette included.
SAVE \$1422

WAS \$14,682 **\$13,260**

\$99 DOWN DELIVERS 1986 HONDA ACCORD LX

No. H-204. 5 speed, air, AM/FM stereo/cassette, power windows, power door locks, front wheel drive, cruise control.
SAVE \$1034

WAS \$13,022 **\$11,988**

19 To Choose From **Only \$99 Down**

SEE ALL YOU GET:

- Dual power mirrors
- Front-wheel drive
- 2.3 Liter HSC engine
- Electronic fuel injection
- 5-speed manual overdrive
- AM/FM stereo radio
- Deluxe sound insulation
- Rear door child proof locks
- Tachometer
- Power front disc/rear drum brakes (split diagonal system)
- Tinted glass
- Power flow-thru ventilation
- Shift indicator light
- Front stabilizer bar
- Power rack-and-pinion steering

RAINBOW OF COLORS TO CHOOSE FROM!

\$99.00 DOWN / \$149.19 per mo.

Sale price \$7770, \$99 down, 59 months, int. \$3610.71, APR 12.9, residual \$2825, total payments \$11,479.71.

\$99 DOWN DELIVERS 1986 CIVIC 3 DOOR DX

No. H-209. 5 speed, radial tires, body side moldings, tinted glass, intermittent wipers, front wheel drive.
\$6888

WAS \$7919 **\$6888**

\$99 DOWN DELIVERS 1986 HONDA ACCORD DX

No. H-133. Front wheel drive, automatic transmission, power steering & brakes, sport stripes, AM/FM stereo cassette.
\$9288

WAS \$10,710 **\$9288**

Emmett Harrison's THEISEN MOTORS

For Over 32 Years The Easiest Place In The World To Buy A Car

701 MAIN AVE. E. TWIN FALLS 733-7700

Music Fest teachers share their art tastes in CSI concert — D2

'Invasion of Mars' an out-of-this-world movie remake — D4

Salt Lake City fills with arts festival, theater offerings—D7

Friday Special

Friday, June 20, 1986

Features, entertainment

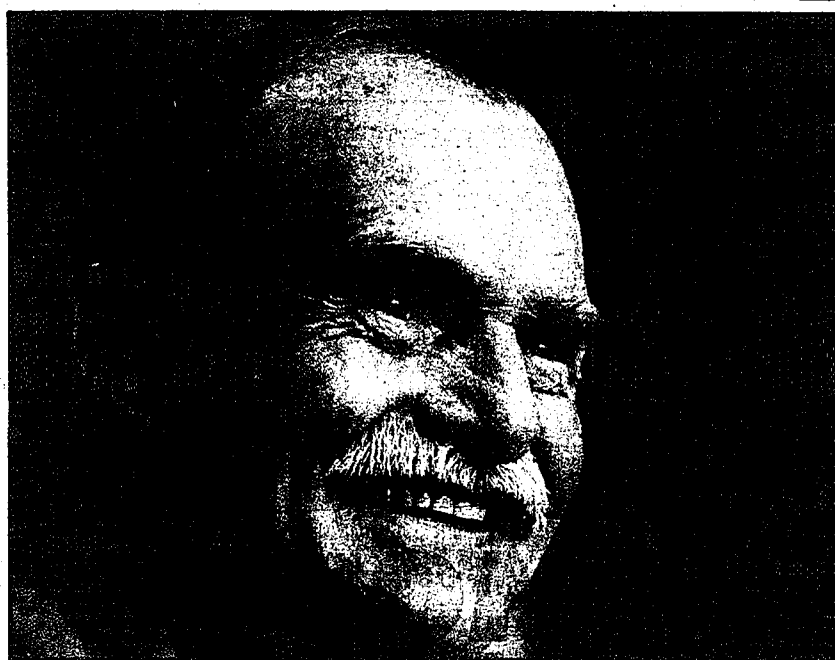

Times-News photo/EVY SAVENSON

Good-natured Jack Hemingway is currently promoting his new book, 'Misadventures of a Fly Fisherman'

Hemingway: very Idahoan

Outdoorsman basks in state's fishing, hunting resources

By TERRY RICH HARTLEY
Times-News correspondent

KETCHUM — Idahoans are quick to bag both Ernest Hemingway and Ezra Pound in their literary creed, ignoring that Hemingway used Idaho as a sanctuary from work and as a retirement home, while Pound never saw the Gem state after he was 18 months old.

Fortunately for our collective egos, entrenched myths stay entrenched. Pound's birchplace in Halley still stands to remind us he was ours, and Ketchum's Jack Hemingway is busy scoring his own writing success, which keeps that august surname in the literary forefront.

But, unlike his father and Pound, Jack Hemingway really is an Idaho creature; his addiction to this state's trout and game birds assures that, not to mention that in 1949 he married one of the state's own — Puck Whittlesey, daughter of a Twin Falls beer distributor. Quick with a smile, the good-natured son of a legend now thrives in the Wood River Valley where he works as well as plays.

A self-proclaimed fishing and hunting nut, Hemingway not only uses the area's resources for his own delight, but in true public spirit served on the Idaho Fish and Game Commission from 1970 to 1976 where he was involved in policy setting — some of which was controversial.

"I think the public views the Fish and Game's job as one of promoting hunting and fishing. But that's not correct," he says. "I think the Fish and Game commissioners are literally responsible for the situation that makes hunting and fishing possible. Members have an obligation to the resource."

Regardless, population pressures have brought a vast change in the outdoor sports scene he first touched a dry fly down on Idaho's streams. "One of the reasons I'm not fishing

my favorite spots on Silver Creek or Henry's Fork is that you can't find a place to be by yourself anymore," he says, adding that guides are taking people to most of the places that used to go almost unnoticed except by the most avid fishermen.

Laughing, he adds, "Guides are even guiding behind my house. There's a point of diminishing returns when so many people are involved. But, I have a solution. I've given up the search for giant fish. It's where you go that counts — the back country, small streams. You can still hike to private places. I'm seeing the state from a new perspective. Always before I've seen it from stream bottoms."

'I may be a dismal failure at writing hard, but I'm a great success at doing what I want.'

Currently promoting his autobiography, "Misadventures of A Fly Fisherman: My Life With And Without Papa," Hemingway just completed three weeks of touring the media circuit in Boston, New York City, Chicago, Los Angeles, San Francisco and Seattle. Last Saturday, he was busy autographing copies at Jud's Bookstore in Twin Falls and last night he appeared in Boston on the popular regional radio show, Merrill at Midnight.

Fortunately for the wiry wit, his sense of self is clear, and when those inevitable questions come regarding his more famous father, and his daughters, Margaux and Mariel, he shows no sign of irritation. "But then, high profile names are nothing new to a guy who grew up in a world that, to the rest of us, seems like a moving picture of the lost generation."

To Hemingway, Ernest was Papa, and Gertrude Stein, Ezra Pound, Ford Maddox Ford

and Gary Cooper were "the other people passing through."

But, if he isn't overwhelmed, neither is he falsely humble about his background. "Having the Hemingway name is obviously more of a plus than a minus," he says.

"Growing up for me was sort of the opposite of what others experience. My parents divorced when I was three and I would spend the summers with my father. I was always on a train or a ship traveling back and forth to Europe. I thought that kids who didn't have two sets of parents were disadvantaged."

Yet, he doesn't pretend that his entire life has been a booming success. College never seemed to be his forte, having dropped out of both Dartmouth and the University of Montana. His World War II days with the elite Office of Strategic Services behind enemy lines ended with his serving six months in a German prisoner of war camp.

As a stockbroker in San Francisco he was able to make a living but had no inclination to get rich at the task. Now, with inheritance money and his own book royalties, he's content to live with his outdoor sporting obsessions and his plans to write thriller novels even though "there will be odious comparisons" made to his father's works.

Jack Hemingway, however, has no intention of trying to emulate Papa. LeCarre and Ludlum spy thrillers provide his favorite reading and will heavily influence any future works he may create.

Yet, even those plans may take awhile — they certainly will take second place to his recreation along stream banks and fields flush with birds. He describes himself best through a dash of smile: "I've probably done more of the things I've wanted to do than anybody around. I may be a dismal failure at working hard, but I'm a great success at doing what I want."

Papa's novel, son's memoirs hit shelves

By TERRY RICH HARTLEY
Times-News correspondent

KETCHUM — Though nearly 25 years have passed since the death of Ernest Hemingway, the legendary name continues to appear on not only reprints but new books as well.

The latest Ernest Hemingway novel, "The Garden of Eden," published by Scribners, recently appeared in bookstores simultaneously with Taylor Publishing's release of Jack Hemingway's "Misadventures of A Fly Fisherman: My Life With And Without Papa."

"Misadventures," while not meant to be a literary masterpiece, is a personal accounting by Jack Hemingway of his own life as the eldest son of Papa Hemingway. Jack says he began working four years ago on a book, which was meant to concern only his fishing adventures. "But I tired of that," he says. "Besides, there are already too many fishing books out."

Like most adventures of the mind, while searching his memory for fishing trips, other parts of his life began to come out. Consequently, "Misadventures" begins with young Jack's

birth in Toronto, Canada, then follows him through his early days in Paris, his parents' divorce and other major events in his life.

"Yet, the art of fishing never leaves the story, whether it is Captain Hemingway of the famed GSS parachuting into occupied territory armed with a fly rod, or civilian Hemingway landing three steelhead with three casts on a Pacific Northwest stream."

A serious undercurrent lurks in the memoirs, one which tows the reader into Papa's life. Readers get to share a son's view of that 20th century literary giant from his macho days in Cuba to his complete deterioration in Ketchum.

"The Garden of Eden," on the other hand, is an attempt by Scribner's to raise from the dead a Papa Hemingway novel. Jack Hemingway says the publisher carved the book out of some 1,500 pages of raw manuscript written by Papa.

"None of the things published posthumously were ready for publication in his (Papa's) point of view or they would have been published,"

says Jack. "However, this is the best edited of them. It's immensely readable and definitely Hemingway. I talked to other people who had access to the manuscript and they thought it was gobbley gook. But this story was right there, well filled out," he says, explaining that "Garden" had been pared out of a much larger, encompassing story.

"The other (encompassing story) had no rhyme or reason to it and could not be brought to the conclusion, I guess. My father had a loss of faculties in his later years," says Jack, commenting on the rambling nature of the manuscript.

Concerning "Garden," one reviewer says, "The story is, superficially at least, a heavily mythologized version of the breakup of his first marriage."

Whether that is accurate, or whether the novel is really "Hemingway" or not, will have to be decided upon by the reader.

Both books are currently available in area bookstores. "Misadventures," 223 pp., sells for \$17.95. "Garden," 247 pp., is \$18.95.

Music festival to fill valley with melodies

SUN VALLEY — The Fifth Annual Wood River Music Festival is slated to run from June 28 to July 18 at various locations throughout the Wood River Valley.

On June 28 at 8 p.m., the Sun Valley Opera House will be the site for "An Evening With Claude Bolling." Bolling, a six-time winner of the Grand Prix du Disque, has received international acclaim as a composer, conductor, pianist and arranger.

Appearing with Bolling will be Pamela Sklar and Jack Wilkins. Sklar has performed as solo flutist with numerous orchestras and ensembles and toured with Bolling in the U.S. and Canada. Wilkins, a guitarist, has performed with a variety of jazz greats, including Buddy Rich, Earl Hines, Benny Goodman, Lionel Hampton and Larry Coryell. Bassist John Goldsby and drummer Vincent Cordlette will travel from France with Bolling to perform on this American tour.

The Presbyterian Church of the Big Wood in Ketchum will be the site of a Kronos Quartet performance at 8 p.m. July 2. The program will include Peter Scherz's "String Quartet No. 8," Aulis Sallinen's "String Quartet No. 3," Mel Graves' "Pangaea" and "String Quartet No. 12" by Shostakovich.

At 8 p.m., July 6, the Utah Symphony Orchestra will appear at the Sun Valley Skating Center to perform Rossini's overture to "Barber of Seville," excerpts from "Roméo and Juliet" by Berlioz, Falla's "The Three-Cornered Hat," Copland's "Billy the Kid," and from Gershwin, "American in Paris."

For those paying for terrace seating, a buffet dinner will be held at 6:30 p.m., prior to the concert. On July 9, entertainment will

return to the Church of the Big Wood when the Al Pine Jazz Band appears for a young peoples' concert at 6:30 p.m.

Part One of the concert will be a discussion and demonstration of the instruments, their sounds and how they relate to one another in a jazz composition. Part Two will be a performance with selections from the ensemble's mainstream jazz repertoire.

The Opera House will again come to life on July 12 at 8 p.m. when the chamber ensemble of piano, oboe and strings — An die Musik — appears. The group's program includes "Quartet for Piano and Strings in E-flat Major, Op. 16" by Beethoven, the Bach-Mozart "Prelude and Fugue in F Minor for Violin, Viola and Cello," Mozart's "Quartet for Oboe and Strings in F Major, K. 370," Schubert's "Trio for Violin, Viola and Cello in B-flat Major, D. 471" and Mozart's "Quartet for Piano and Strings in E-flat Major, K. 451."

The Music Fest will climax at the Trail Creek Cabin Grounds with the High Sierra Jazz Band performing a picnic concert. That final program will include the traditional Dickelard Jazz of Jerry Roll Morton, Bix Beiderbecke, King Oliver, Louie Armstrong, John Handy and others.

This project is presented with support from the Idaho Commission on the Arts and the Western States Arts Foundation with funds from the National Endowment for the Arts.

Tickets are now on sale at the Sun Valley Center Gallery and Chapter One Bookstore in Ketchum, the Sun Valley Sports Center and Ex Libris Bookstore in Sun Valley, and The Sound Socket in Halley. For ticket prices and information, call Jack Wilson at 622-9371.

New books expose Idaho literature

By TERRY RICH HARTLEY
Times-News correspondent

BOISE — "What Thou Lovest Well Remains: 100 Years of Ezra Pound" and "The Literature of Idaho" are books rooted in Idaho.

"What Thou Lovest," published by Limberlost Press less than a year after the Ezra Pound Centennial Conference last October in Halley, the poet's birthplace, features 23 writers commenting on Pound, his influence on world literature and his controversial stand on fascism. Included is an essay on poetry by William Studebaker, College of Southern Idaho associate professor of English.

Other commentators are by Allen Ginsberg, who knew Pound personally, and John Clellon Holmes, author of "Gone in October: Last Reflections on Jack Kerouac," who held Pound in reverence.

Editor Richard Ardinger says, "Robert Creeley once wrote that of the poets he studied at Harvard, Pound was more than any other poet demonstrated through his poetry how to write poetry. I believe that all of the contributors to this anthology would agree with this. Nearly all the contributors are poets.

"It is my hope that this eclectic mixture of essays and poems will offer experienced and uninitiated readers a glimpse of the great power

and vast range of Pound's vision and influence. It also is my hope that the reader will learn as much about the writers of 100 essays as they will about Pound."

"The Literature of Idaho," published by Boise State University as part of its Hemingway Western Studies, is an anthology with selections from the ancient oral narratives of Idaho's Indian peoples to the most recent essays, poems, novels and stories about the state.

In it, one can read a variety of works that extend from Studebaker's poem, "Standing On The Yankee Fork Gold Dredge Out Of The Rain," to Vardis Fisher's short story, "Odyssey Of A Hero," or Ernest Hemingway's "The Shot."

Editor James H. Maguire says, "This anthology is intended to be a gathering and sampling of literature, not a literary chronicle. Not all the selections are belles-lettres, but almost all of them are literature in the sense of writing that lasts and generally receives more praise than other writing."

"What Thou Lovest Well Remains," 135 pp., sells for \$9.95. "The Literature of Idaho," 330 pp., is priced at \$17.95. It can be ordered through area bookstores or from the Boise State University Bookstore, 1910 University Drive, Boise 83725; for experienced and uninitiated readers a glimpse of the great power of \$1 must accompany the order.

Check this



Earth Fair celebrates nature

Nature inspires many an artist, but at the Wood River's third annual Earth Fair, the focus is on arts and crafts produced entirely of materials in their natural forms.

Musicians, weavers, dancers and other artists will explore "the old ways, when mankind was young," say fair organizers.

The Earth Fair is held on the summer solstice, this Saturday and Sunday, in the Halley City Park, opening each day at 10 a.m.

Music Fest clinicians to play

TWIN FALLS — A special feature of Music Fest '86 will be a concert with two of the clinicians at 8 p.m. Wednesday in the College of Southern Idaho Fine Arts Center.

Dr. Warren Burton, who heads the Utah State University Music Department, and Allen Vizzutti, an award-winning trumpet player, will perform. Burton is known nationwide as a cellist, music educator, clinician and conductor, while Vizzutti, who recently returned from Expo '86 as a featured jazz artist, often performs with Johnny Carson's The Tonight Show band.

Tickets for the concert are \$4.50 adults, \$2.50 students. They are available at Welch Music, Warner Music, Claude Brown's, The Music Center and the CSI Bookstore in Twin Falls; Sav Mor Drug, Buhl; Thrifty Way Drug, Jerome; Magic Music, Ketchum; and the Burley Continuing Education Center and Welch Music in Burley.



DR. WARREN BURTON
USU Music Department head



ALLEN VIZZUTTI
Back from Expo engagement

Scholarship winners named

TWIN FALLS — More than \$2,400 in scholarships has been donated by Magic Valley groups to assist students attending Music Fest '86, June 23-27, at the College of Southern Idaho.

Twin Falls Music Club scholarships were awarded to Holly Jennifer Emery, Rachel Harrell, Mike Bulgin, Janet Waldron, Karen King, Kimberlee Dodds, Jenny Cluff and John Hoover, Twin Falls; Michael Gibson, Hansen; Jana Watts, Murrumbidgee; Kevin Pullman, Kimberly; Cindy L. Johnson, Jerome; Jennifer Koolman, Mistleynn Parnell, Carl Kohntopp and Mike Hopwood, Buhl.

Recipients of Magic Valley Dilettantes scholarships are Melodie Mecham and Angie Johnson, Hazelton; Kamela Evans, Clay Quinton, Stephanie Stringer, Marcus Day, Cy Gilbert and Renee Barkman, Twin Falls; and Pat Evans, Buhl.

JUMP Company scholarships were given to Bobbie Vineyard, Buhl; Penni Auterheide, Filer; Arner Roberts, Jerome; and Kim Wright, Twin Falls.

Twin Falls Kiwanis Club scholarships went to David Gibson, Buhl, and Jeff Lytle and Natalie Egbert, Twin Falls, while Burley Music Club scholarships were given to Dave Hanson, Dave Miller, Jana Miller and Patricia Ward, Oakley; Dori Brower, Derrin Dorman, Carrie Draper, Lane Martin, Sherrie Reay and Brad Staekler, Burley.

Receiving scholarships from the Magic Valley Chorale were Jenelle Hansen, Buhl; Trista Helms, Twin Falls; and Melanie Snow, Gooding. Buhl students receiving scholarships from Buhl Kiwanis Club are Shawn Barigar, Cynthia Castro and Pat Evans. Gooding Rotary awarded scholarships to Penny McClure and Melanie Snow, both of Gooding.

Magic Valley Symphony scholarships went to Brad Stancerson, Jennifer Call, Andy Durham and Tammy Egbert, Twin Falls; Nicole Golay, Kimberly; and Tim Flemming, Lori Schialek and Stephanie Zinn, Buhl.

Julie Lively, Filer, and Marcel TurVeem, Twin Falls, received funds from Idaho First National Bank. Wendy Merchants are sponsoring Michael Gibson, Wendell, and United First National Bank is assisting Andrea Kadlec, Twin Falls. A scholarship from Twentieth Century Club is yet to be awarded.

The camp students will present a free concert at 7:30 p.m. June 27 in the CSI Fine Arts Center. Family and friends of the students are invited to a no-host buffet dinner on the Fine Arts Patio at 5:30 p.m. prior to the concert. There will be musical theater and entertainment during the dinner.

Paul Shindig set Saturday

By CLAUDE CHAMBERLAIN
Times-News Intern

PAUL — Breakfast at the American Legion Hall, marathon racing and the dedication of the city park are all part of the day-long 8th Annual Paul Shindig Saturday, organized by the city's Chamber of Commerce.

Various activities will be taking place throughout the day, starting with breakfast at 6 a.m. at Post #77 of the American Legion on Wayne Street. The cost will be \$3.50 per adult.

At 8 a.m., registration begins for the Road Race. There will be a two-mile and a 10-kilometer course, both starting at 9 a.m. at the Paul City Park. The entry fee is \$6.

All competitors in the races will receive t-shirts. Ceramic cups with running logos will be given to the first male and female finishers. Top finishers in each age group will receive a cap commemorating the 8th Annual Paul Shindig.

Age groups are: 17 and under, 18-29, 30-39, 40-49 and

50 and over. For more information, call Robln Haun at 438-5544 or 438-5313 after 6 p.m.

Retired Paul businessman Ted Winn will be the Grand Marshal of the Paul Shindig parade, which will start at 1 p.m. A special section of the parade will be designated for the children of the community, said Glenn Dick, parade manager.

Groups or individuals with parade entries are asked to be at the Paul Elementary School by noon for organization and judging purposes.

Following the parade will be the dedication of the city park by the Chamber of Commerce to mayor Robert Larson, who died in April, and to the late city clerk Judy McLean. A redwood sign recognizing the dedication will be erected at approximately 2 p.m.

Other activities in the park will include food and crafts booths, entertainment and drawings for prizes all afternoon. The Grand Prize, provided by the Chamber of Commerce, will be a trip for two to Hawaii. Other prizes have been donated by local merchants.

Piano concert slated

JEROME — The Jerome Rotary Club presents pianist Jed Moss in a benefit concert at Jerome High School auditorium on Wednesday at 8 p.m.

Moss will perform the works of Bach, Mozart, Beethoven, Chopin, Ravel and Liszt.

Moss, son of Mr. and Mrs. Ray Moss of Jerome, studied piano with Georgia Blastock of Filer; Margaret Ott of Spokane, Washington; Lennox Larson and currently with Gladys Gladstone at the University of Utah. Moss graduates this year with a bachelor of arts degree in piano performance.

At the age of 15 he performed with the Idaho State Civic Symphony. He has performed with the Magic Valley Symphony Orchestra and also the University of Utah Symphony Orchestra.

He has also been the featured artist in the Temple Square Series in Salt Lake City with an orchestra comprised of Utah Symphony and

32 Brand New HONDAS
Just arrived.
All colors, all specially priced!
THEISEN MOTORS
701 Main Ave. E. 733-7700

EASLEY HOT SPRINGS
Open May 29 - Sept. 1
SWIMMING POOL, CAMPGROUND & CONVENIENCE STORE
Open 7 Days A Week
Mon.-Sat. 10-7 & Sun. 2-7
12 Miles North of Ketchum
726-5007

Calendar

If you have an item for The Times-News entertainment calendar, mail it to: The Times-News, Box 548, Twin Falls, 83303, or bring it to our office 132 Third St. W. We must receive your notes by Wednesday evening, 11:30 p.m. in that week's "Friday Special." The listing in the calendar is free, but events must be open to the public.

20/Today

BOISE — The El Korah Shrine Circus will perform at 2 and 8 p.m. at the Boise State University Pavilion. Admission is \$7 for adults and \$3.50 for children 12 and under.

HAGERMAN — Diversion will play at 8:30 p.m. at the Angler's Lounge.

HAZELTON — The Rendezvous Band will play at 8 p.m. at the Landmark.

JEROME — The Northside Playhouse production of Meredith Willson's "The Music Man" will be presented at the Jerome High School at 8:15 p.m. Admission is \$4.50 for adults and \$3.50 for senior citizens and children 12 and under. Tickets are available at Jud's Bookstore, Valley Schwinn Cycles and Ann's Hallmark in Twin Falls; at the Natural Way Health Store, Wild West Video and the Wrangler in Jerome. Tickets may also be purchased at the door.

TWIN FALLS — The Disabled American Veterans Auxiliary will hold a public dance at 8:30 p.m. at the DAV Hall, Harrison and Shoup streets. Music will be provided by the Old Time Fiddlers.

21/Saturday

BLISS — Diversion will play at 9 p.m. at the Y-Inn.

BOISE — The El Korah Shrine Circus will perform at 2 and 7 p.m. at the Boise State University Pavilion. Admission is \$7 for adults and \$3.50 for children 12 and under.

HAZELTON — The Rendezvous Band will play at 8 p.m. at the Landmark.

JEROME — The Northside Playhouse production of Meredith Willson's "The Music Man" will be presented at the Jerome High School at 8:15 p.m. Admission is \$4.50 for adults and \$3.50 for senior citizens and children 12 and under.

22/Sunday

BOISE — The El Korah Shrine Circus will perform at 2 p.m. at the Boise State University Pavilion. Admission is \$7 for adults and \$3.50 for children 12 and under.

JEROME — The Red Rock Band will play at 9 p.m. at the Northern Tavern.

TWIN FALLS — "Strictly Classics" will be broadcast from noon to 3 p.m. on radio station KTFI.

25/Wednesday

JEROME — The Jerome Rotary Club will present pianist Jed Moss in a benefit concert at 8 p.m. at the Jerome High School auditorium. Admission will be \$4 for adults and \$3 for senior citizens and students.

Moss will perform works by Bach, Mozart, Beethoven, Chopin, Ravel and Liszt.

TWIN FALLS — A special feature of Music Fest '86 will be a concert with two of the clinicians at 8 p.m. in the College of Southern Idaho Fine Arts Center. Cellist Dr. Warren Burton, who heads the Utah

State University Music Department, and Allen Vizzutti, an award-winning trumpet player, will perform.

Tickets are \$3.50 adults, \$2.50 students. They are available at Welch Music, Warner Music, Claude Brown's, The Music Center and the CSI Bookstore in Twin Falls; Sav Mor Drug, Buhl; Thrifty Way Drug, Jerome; Magic Music, Ketchum; and the Burley Continuing Education Center and Welch Music in Burley.

27/Friday

HAILEY — A family fun night will be sponsored by the Northern Rockies Folk Festival beginning at 6:30 p.m. at the Lions Park. Music will be provided by the Boulder Brothers and the Siles and Ivy Band and other guest musicians.

Refreshments will be available. An auction will be held later in the evening to raise funds for the festival scheduled for July 29 through Aug. 3 in Hailey and Elkhorn. Items to be auctioned include mountain bikes and dinners for two in local restaurants. To donate goods and services to the festival, call Kit Neeras at 622-3371 or write to P.O. Box 656, Sun Valley, Idaho. All gifts are tax-deductible.

TWIN FALLS — "Diversion" will play at 9 p.m. at the Klover Klub.

Ongoing

TWIN FALLS — The works of art by Twin Falls artist Beverly Ziegler will be on display at Larson Arts through the month of June. The exhibit includes oil paintings, watercolors, woven hangings, pillows and wearable items. Watercolors by Montana artist Ken Hansen are also on exhibit. Hansen's work has been featured in "American Artist" magazine and he is a member of the National Watercolor Society and vice-president of the Montana Watercolor Society. Viewing is from 9 a.m. to 5:30 p.m. Monday through Thursday at 132 Main Ave. N.

Upcoming

BELLEVUE — A musical fund-raising event will be held June 29 at 2 p.m. at the Bellevue City Park. "Music in the Park" will feature performances by the Idaho Old Time Fiddlers, the Boulder Brothers and the Good Old Boys.

Admission charge is \$2 per person or \$5 per family. Pop, popcorn and cotton candy will be available for purchase. Proceeds will go toward improvements on the tennis court.

SUN VALLEY — The Idaho Indian Show will be held July 3-6 at Elkhorn Lodge. The show will have 15 dealers selling Indian jewelry, baskets, pottery and weaving, both new and antique. Indian artifacts will be sold and bought. For more information, contact: The American Indian Traders Guild, 3876 E. Fedora Ave., Fresno, Calif.

WELLS, Nev. — A rodeo weekend will be held June 28 and 29 at Wells, Nev., beginning with a barbecue at 6 p.m. June 27 at Wells City Park. Cost is \$3 for adults and \$1 for children 12 and under.

Rodeo performances will begin at 1 and 5 p.m. June 28 and at 1 p.m. June 29. Admission is \$4 for adults, \$3 for ages 6-17 and children under 6 are free. A parade will be held at 11 a.m. June 28.

TWIN FALLS — The Gun and Antique Show will be held at 9 a.m. June 28-29 at the National Guard Armory. Items to buy or sell will include guns, collectibles, Indian artifacts, knives, art, crafts, jewelry and coins. For information, call 746-5555.

Native arts awards given

BOISE — The Idaho Commission on the Arts has awarded five additional apprenticeships worth over \$7,000 to Native Americans to learn traditional arts from skilled masters.

The awards, the second grouping made under the new program, are designed to help Idaho's Indian communities develop and preserve their traditional native arts. Apprenticeship grants provide materials, travel costs and a fee for the master artist. Grants were made to the following:

Delphina Jim, Shoshone-Paiute (Duck Valley), \$1,356 to teach cradleboard making to Sharlin Smart.

Dorothy Wines, Shoshone-Paiute (Duck Valley), \$1,496 to teach cradleboard making to Teola Hall.

Parlene Evening, Shoshone-Bannock (Fort Hall), \$1,500 to teach willow work (cradleboard frames) to Teddy George.

Inez Evening, Shoshone Bannock (Fort Hall), \$1,500 to teach beadwork to Kimberly Evening.

Emma Kendrick, Coeur d'Alene, \$1,500 to teach moccasins making and hide tanning to Marlane Hurley.

The current apprenticeships were chosen June 2 in Bonners Ferry by the Idaho Native American Apprenticeship Panel, a volunteer panel which consists of five Indian representatives, commission folk arts coordinator Steve Siparin and two others.

TWO DAY RACE SPECTACULAR
SATURDAY, JUNE 21 • 7:30 P.M.
SUNDAY, JUNE 22 • 2:30 P.M.

SATURDAY NIGHT RACES START AT 7:30 P.M.
FROM MERIDIAN SPEEDWAY AND SALT LAKE CITY
SUPER-MODIFIEDS (SPRINT)
HOBBY STOCKS

MAGIC VALLEY SPEEDWAY
1 Mile West And 1/2 Mile South Of Twin Falls Airport
734-3700

SUNDAY AFTERNOON RACES START AT 2:30 P.M.
PRO STOCKS, HOBBY STOCKS

'Invaders from Mars' lands with an oddly funny '50s feel

TWIN FALLS — Following are capsule reviews of films currently playing in the Magic Valley. Ratings are by the Motion Picture Association of America and the Los Angeles Times. Opinions are by Los Angeles Times reviewers.

INVADERS FROM MARS (PG). Tobe Hooper's faithful remake of William Cameron Menzies' 1953 sci-fi thriller — which, back then, fused standard Cold War thrills with a Gothic, Expressionist twist — has a vaster budget, a modern perspective and a lot of reflexive inside humor. The story is paradigmatic — a little boy protagonist lost in a town full of Martian-dominated zombie adults — but Leslie Dilley's production designs are lush, the actors are better and the Martians (which resemble leering

Movie reviews

'Invaders' — D4

globs of melting ice cream) are an extraterrestrial gas. When Hooper gets the languorously empty, paranoid '50s feel he wants, this movie — verges on being hysterically funny.

BACK TO SCHOOL (PG-13). A big belly laugh of a comedy, expertly tailored to the talents of Rodney Dangerfield, cast as a boisterous self-made clothing tycoon who enters college to set a good example to his wallflower son (Keith Gordon). A sleek, witty Sally Kellerman is Dangerfield's English

prof. and a hilarious Adrienne Barbeau is Dangerfield's social-climbing, two-timing wife. With Robert Downey Jr., Burt Young, Ned Beatty, Terry Farrel.

FERRIS BUELLER'S DAY OFF (PG-13). Teen chronicler John Hughes has condensed the mythic teen-ager, Ferris Bueller (Matthew Broderick), a giddy scamp who is too savvy for his parents, too cool for school and an absolute terror when it comes to restaurant maître 'd'es. The film's hook is a tantalizing fantasy, for adults as well as kids — what if you could fool your parents and teachers (for that matter, your boss) into thinking you were sick, earning yourself a 24-hour free ride from the boredom and responsibilities of real life? But Hughes miscalculates badly, mak-

ing his hero so smug and invincible that he doesn't give us any chance to root for him.

THE MANHATTAN PROJECT (PG-13). A teenage scientific whiz (Christopher Collet) takes advantage of the kindnesses of his mother's atom-scientist suitor (John Lithgow) to build some high-grade plutonium and steal a nuclear bomb. Also stars Cynthia Nixon and Jill Eikenberry. Directed by Marshall Brickman.

TOP GUN (PG). The biggest, glitziest, flashiest, loudest Navy recruiting ad you'll ever see, full of MIG-Tomcat dogfights, jocular male-bonding, screaming jets and so much techno-pop pounding in your ears the whole thing begins to seem like disco war. The movie is an empty-headed technological marvel: the trappings are flabbergasting —

and the camerawork and editing a knockout — but the story is a clever rehash of "Coolin' Zero" and "An Officer and a Gentleman" drowned in beecake and macho bathos.

COBRA (R). Sylvester Stallone, having pared his "screenplays" down so that he has done away with characterization, logic, coherency, motivation, background and more than six speaking parts, now goes after dialogue. What emerges is a lurid, ludicrous, exhausting, enervating bloody mess of a slasher movie, thundering at you in vast close-up. The villains are not the raggledoggle scum who clank hatchets and consider themselves a master race but the news media, wimps who believe in due process of law and judges who undo the work of one-man arsenals like Stallone. Gaseous vigilantism, this.

Dangerfield drives 'Back to School'



RODNEY DANGERFIELD
Wields his greasy aplomb

By PAUL ATTANASIO
The Washington Post

WASHINGTON — Should you be shopping at the Fall and Fat store? Ask the owner, Thornton Melon (Rodney Dangerfield). "When you go jogging, do you leave potatoes?" he asks in a TV commercial for the chain. "When you get a menu, do you say 'Okay?' And away we go into an exercise in pure, hilarious, uncorruptly corrupt rudeness.

Allegedly "Back to School" is a story about a father and son, Jason Melon (the lamentable Keith Gordon) doesn't like college much — his grades are lousy, his only friend (cloning Robert Downey) has no friends himself, and he could only make the diving team as a towel boy. Dad wheels up in the limo to offer a pep talk, and ends up enrolling as a freshman.

to School" ring pony, and the movie won't advance the cinematic art a whole lot. For the most part it follows the first formula of the teen comedy — complete with bullying Aryan-style jocks who get their comeuppance, a snooty professor, a corrupt school administration and the usual rock 'n' roll, studying and brawl montage. Director Alan Metcalf has left the actors on their own — if they're good, they're good, and if they're not, he doesn't help them any. And you could drive a truck through some of the cues.

But the screenplay is inventive (probably courtesy of Harold Ramis, who co-wrote) and the cast includes some special actors, among them Ned Beatty, playing the smarmy hypocrite "Dean" Martin in high make the diving team as a towel boy. Dad wheels up in the limo to offer a pep talk, and ends up enrolling as a freshman.

crized Vietnam vet turned history teacher.

Besides, criticizing "Back to School" because you don't like the parts without Rodney is like criticizing the circus because you're bored by the fellow who sweeps up behind the elephant. You're there, simply and exclusively, to see Dangerfield, with his bulging eyes and brassy-sniffer hulk, moving through the collegiate crowd with his greasy aplomb, whipping out a checkbook at the bookstore and bellowing, "Hey folks, it's on me — Shakespeare for everyone!"

If "Back to School" is nothing more than a jury-rigged showcase for Dangerfield's stand-up routine, the result is nevertheless as funny as any movie this year. Awkward and twitchy, Dangerfield is something of a bully in behalf of his values — cheap sex and expensive surroundings — but he's also constantly, touchingly desperate to ingratiate himself. When he commences all that jiggling, it's almost as if he's trying to wrangle his way under your skin. And he does.

Hollywood films bait for production

LOS ANGELES (AP) — Here's another bulletin from the war front: The Hollywood Chamber of Commerce is fighting movie runaways with a new documentary film.

The Chamber, alarmed by the increasingly successful efforts of other states in luring movie production away from Hollywood, has come up with a 22-minute film called "Runaway: A California Crisis."

"We've got to do something to stop a very disturbing trend," said Bill Welsh, chamber president. "California is losing \$1.5 billion yearly in film production to other states. "The human cost in terms of crime, unemployment is enormous. We hope

that the film will alert everyone in the state to the danger to our economy represented by runaway film production."

The documentary, narrated by Dennis Weaver, focuses on the aggressive efforts of five states — New York, Florida, Massachusetts, Texas and Tennessee — to lure producers away from California. These states go all out to accommodate the production companies.

By contrast, says Charlotte Clay, the film's executive producer, filmmakers in California meet nothing but resistance from local government, businessmen and residents.

'Back to School' wins ticket respect

HOLLYWOOD (AP) — Moviegoers went "Back to School" to learn some respect for comedian Rodney Dangerfield and made his new film the weekend's No. 1 box office attraction.

Laughs won out over action as Dangerfield's new film displaced last week's top draw, "Top Gun," and another new comedy, "Ferris Bueller's Day Off," pushed ahead of "Raw Deal" and "Cobra."

"Back to School," which stars the "I don't get no respect" comedian as a boorish businessman who returns to college, grossed \$3.9 million.

"Ferris Bueller," the chronicle of a teen-age's day away from school, sold \$6.3 million in tickets.

"Top Gun," the Navy flyboys adventure film in its fifth week of release, took third place with a gross of \$6.25 million.

Sylvester Stallone's "Cobra," which was in third place last week, dropped 45 percent in its fourth weekend and fell back one notch with a take of \$2.8 million. That was the same amount grossed by musician Arnold Schwarzenegger's "Raw Deal," which dropped almost 50 percent in its second weekend and fell from second place.

"Poltergeist II," in its fourth week, took in \$2.2 million to make it the weekend's sixth highest-grossing film, while "Short Circuit," in its sixth week, was close behind with \$2.1 million.

"Don't Lock Your Bedroom Door!" Try "The Get-Away"



Private SPA rooms with Jacuzzi - Waterbeds, Waterfalls, Carports, Skylights & More. Large towels supplied. (Some restrictions apply.)

SPAS 1/2 OFF W/ROOM

"Especially for you Mom and Dad!" Rekindle your relationship. Gift certificates available. Reasonable hourly rates - reservations for better service - It's unique!

Rock Lodge 736-4822
Hagerman, Idaho OPEN DAILY 12 to 9 p.m.
On Billingsley Creek in the Hagerman Valley CLOSED MONDAY

Compri Hotel's \$35 a night, "sleep next to Shakespeare," Boise Weekend.



The Compri Hotel is right next door to the Idaho Professional Theatre Company. And during the annual Shakespeare festival, they will be performing one of his classics. So when you stay at Compri, you'll get \$2 off your festival tickets. Plus, for \$35 you'll also get to bubble in our whirlpool, watch HBO movies, relax with some cocktails and enjoy a bedtime snack. And in the morning we'll even make you a full, cooked-to-order breakfast. The \$35* per room per night, sleep next to Shakespeare, weekend. Only at Compri. Two adults per room. \$10 for each additional person over 12 years. Children under 12 stay free. 475 ParkCenter Blvd., Boise. For reservations, call (208) 345-2002 or

1-800-4-COMPRI.
Lakewood (West Denver), CO • Pleasanton, CA • Ontario, CA
Newport/Santa Ana, CA • Boise, ID

*Rate effective through August 31, 1986.

(Compri) Hotel
BY DOUBLETREE

Reserve Your Movies Today At ...

STUDIO 2001

"Revolution"
"Jagged Edge"
"Troll"
"Back to the Future"

Just Phone 733-2200 To Use Our Computerized Reservation System

NEW SUMMER HOURS:
10:00 A.M. - 10:00 P.M.
Monday thru Saturday
11:00 A.M. - 8:00 P.M. Sunday

COUPON

RENT 2 MOVIES AND GET A 3rd ONE FREE
(Movies Must Be of Equal Value)
Monday thru Thursday With This Coupon
Expires Good Only at STUDIO 2001
Thru July 3, 1986
Not Valid With Any Other Coupon or Special

When you see our movie selection, you'll know why your friends are ranting from Studio 2001.
1136 BLUE LAKES BLVD., TWIN FALLS • 733-2200
Located at North 5 Palms - Corner of Addison and Blue Lakes - Next to Kentucky Direct Circle

| | | | | | | | |
|--|---|------|---------|------|---------|------|---|
| <p>MOVIES</p> <p>PROGRAM INFORMATION</p> <table border="1"> <tr> <td>Twins</td> <td>7:00</td> </tr> <tr> <td>Top Gun</td> <td>7:30</td> </tr> <tr> <td>Gooding</td> <td>8:30</td> </tr> </table> <p>FROM 12 TO 4 ALL ADULTS \$3.50 AND 4 TO 6 ALL ADULTS \$3.00 SAT., SUN., TUES., WED. — TWIN CINEMA • SAT., SUN. — JEROME CINEMA • SUN. — MALL CINEMA ALL SUNDAY NIGHT ALL ADULTS \$3.00 AT MOTOR-VU AND GRAND-VU</p> | Twins | 7:00 | Top Gun | 7:30 | Gooding | 8:30 | <p>INFLATION FIGHTER</p> <p>FRIDAY 7:15-9:10 SAT. 7:15-9:10 SUN. 1:00-3:30-7:15-9:10</p> <p>COBRA</p> <p>THE STRONG ARM OF THE LAW.</p> <p>FRIDAY 7:15-9:10 SAT. 7:15-9:10 SUN. 1:00-3:30-7:15-9:10</p> |
| Twins | 7:00 | | | | | | |
| Top Gun | 7:30 | | | | | | |
| Gooding | 8:30 | | | | | | |
| <p>NO SURRENDER</p> <p>WHEN EVERYTHING IS ON THE LINE.</p> <p>FRIDAY 7:15-9:10 SAT. 7:15-9:10 SUN. 1:00-3:30-7:15-9:10</p> | <p>FERRIS BUELLER'S DAY OFF</p> <p>One man's struggle to take it easy.</p> <p>FRIDAY 7:15-9:10 SAT. 7:15-9:10 SUN. 1:00-3:30-7:15-9:10</p> | | | | | | |
| <p>LEGAL EAGLES</p> <p>THE NEW COMEDY FROM THE DIRECTOR OF GREASE HEATERS</p> <p>DEBRA WINGER ROBERT REDFORD DARYL HANNAH</p> <p>FRIDAY 7:15-9:10 SAT. 7:15-9:10 SUN. 1:00-3:30-7:15-9:10</p> | <p>RAW DEAL</p> <p>Nobody gives him a...</p> <p>FRIDAY 7:15-9:10 SAT. 7:15-9:10 SUN. 1:00-3:30-7:15-9:10</p> | | | | | | |
| <p>THIS WEEK'S #1 SHOW CARE BEARS MOVIE II</p> <p>JEROME CINEMA THURSDAY 12:30-2:30 GOODING CINEMA FRIDAY 10:00-12:00</p> | <p>PHARLAP</p> <p>SUPER SUMMER MATINEE #2</p> <p>His name means lightning.</p> <p>TWIN CINEMA TUES., WED. 10:00-12:30-2:30 JEROME CINEMA THURSDAY 12:30-2:30 GOODING CINEMA FRIDAY 10:00-12:00</p> | | | | | | |
| <p>TOP GUN</p> <p>POSITIVELY ONE OF THE BEST MOVIES OF THIS YEAR!!</p> <p>Tom Cruise Kelly McGillis</p> <p>FRIDAY 7:15-9:10 SAT. 7:15-9:10 SUN. 1:00-3:30-7:15-9:10</p> | <p>BACK TO SCHOOL</p> <p>RODNEY DANGERFIELD</p> <p>FRIDAY 7:15-9:10 SAT. 7:15-9:10 SUN. 1:00-3:30-7:15-9:10</p> | | | | | | |
| <p>THE MANHATTAN PROJECT</p> <p>The most dangerous man on earth.</p> <p>FRIDAY 7:00-9:30 SAT. 5:00-7:30 SUN. 4:15-6:00</p> | <p>SHORT CIRCUIT</p> <p>OPEN FRIL-TUES. FOR THE WHOLE FAMILY</p> <p>FRILY SHEELY STEVE GUTENBERG</p> <p>PLUS WAITING THIS IS OVER.</p> <p>LOUIS GOODE JR IRON EAGLE</p> <p>OPEN 8:45 STARTS 9:15</p> | | | | | | |
| <p>NO SURRENDER</p> <p>TONIGHT, HE EITHER FIGHTS FOR HIS LIFE OR HE'LL BE RUNNING FOR THE REST OF IT.</p> <p>FRIDAY 7:15-9:10 SAT. 7:15-9:10 SUN. 12:30-2:30 4:15-5:50-7:30-9:10</p> | <p>NO SURRENDER</p> <p>FRIDAY 7:15-9:10 SAT. 7:15-9:10 SUN. 12:30-2:30 4:15-5:50-7:30-9:10</p> | | | | | | |

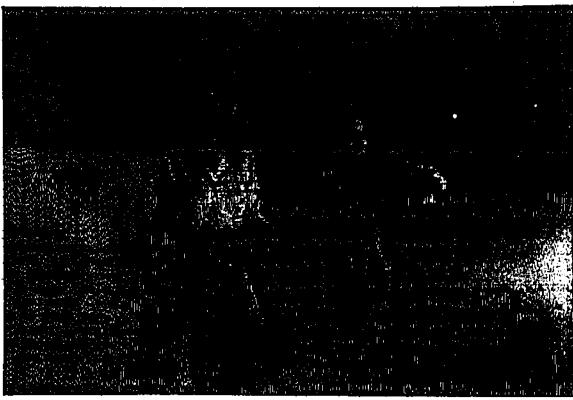

Linda (Karen Black), left, and David (Hunter Carson) find terror in the tunnels

'Invaders from Mars' gets a much improved remake

By MICHAEL WILMINGTON
Special to the Los Angeles Times

HOLLYWOOD — To be Hooper's remake of "Invaders From Mars" is set in a small Midwestern-looking town: Anywhere, U.S.A. There, Mom, Dad and little David Gardner — as homey a trio who will ever meet — gaze up into the night. But the sky shakes oddly.

Some weird, inexplicable something is about to descend into the sand pit out back. Mom and Dad will disappear past the hill and picket fence, then come back with strange, vacant expressions — and screws in the back of their necks.

Investigating police are going to prow around, get sucked into the pits and turn up later with the same scared necks and vacant stares. Soon, no matter where David runs, he is going to find people with screws in their necks, gazing at him oddly; his classmates, his teacher, strangers on the street.

It is a nightmare, obviously; and a peculiarly 1950s sort of that. When director-designer William Cameron Menzies made the 1953 "Invaders From Mars," he and screenwriter Richard Blake were serving up standard Cold War-era chills with a Gothic twist.

Hooper makes the movie faithfully. He does not really try to update or refashion it, like Philip Kaufman with "Invasion of the Body Snatchers" or John Carpenter with "The Thing." He simply does the movie over again — with a vaster budget, a modern perspective and a lot of reflexive inside humor. (Examples: The Gardners live in the same house they did in 1953, but it is now called Santa Mira, site of Don Siegel's similarly themed "Body Snatchers"; a "Body Snatchers" pod lies with some junk in a basement; David goes to Menzies Public School, and Hooper's police chief is played by Jimmy Hunt, who was David in the 1953 original.) Hooper is trying to make a more self-referential, self-conscious version of "Invaders" — his ideal version.

But his treatment is lush. He can realize everything the 1953 movie makers had to leave out — letting John Dykstra create a trickier spaceship,

and the designers provide tastier aliens. Menzies' Martians looked like two wrestlers in green, velvet jump suits, ordered around by a silver-painted, tentacle head in a fishbowl. (That same head turns up here in the school basement, along with the pod.) Hooper's E.T.-types look like four-legged, leering globs of melting ice cream, and they truck around funkiely, as if cartoonist R. Crumb were animating them.

In the original, the acting was incredibly bad: When the characters turned into zombies, you could barely tell the difference, except for their blank scowls. Here, the actors are trying deliberately to overplay. Karen Black is sitcom-momish as the nurse-heroine; Timothy Bottoms and Laraine Newman give the elder Gardners a cult-victim vacuity. In 1953, at the height of the Red scare, the possessed parents were surlier, more like terrorists.

James Karen has a field day as a macho Marine general, and Louise Fletcher amusingly parodies here Nurse Ratched as an evil schoolteacher. In "Life Force," Hooper was accused of having no sense of humor, and here he seems to be designing the movie to contain the audience reactions beforehand; kidding himself before anyone else has a chance.

The humor is there. Co-senarist Dan O'Bannon uses the deadpan grotesquerie he had in "Return of the Living Dead." How can any one think a movie with lines like "Martians have no qualms about killing Martians!" is not intended to be funny?

You can sympathize with the people who think "Invaders From Mars" is a botch; there is something so anachronistic and out-of-scale about it. But they are missing something. If you can tap into Hooper's oddball rhythms and cold sendups, you can enjoy yourself.

And, though the 1953 "Invaders" was an effective movie, it is not really the classic that people remember. Except for Menzies' superb production designs, everything in the remake is better: the acting, the camera work, definitely the Martians. It may not grip audiences in the same way, but that is because Hooper is trying something harder, a conscious campiness that is tough to bring off.

Center offers summer art sessions

SUN VALLEY — The Sun Valley Center for the Arts and Humanities is presenting a number of workshops this summer as part of its Centerecso program.

A Monoprint Workshop is being held June 23-27 from 9 a.m. to 4 p.m. each day. Instructor David Wharton will hold the class at the Sun Valley Center Printmaking Studio. The fee is \$150; \$120 for center members.

A Fiber Workshop will be held at the Community School, July 7-18,

from 9 a.m. to 5 p.m. each day. Stefanie Dash Marvick will teach tapestry, while Rudy Kovacs will teach weaving. Fee is \$300; \$250 for center members.

A Photography Workshop will consist of a darkroom crash course to be held at the Sun Valley Center Photo Building, Mondays, Tuesdays and Wednesdays from June 30-July 2, 6 to 9 p.m. Instructors will be Jack Williams and Carol Montevede. Fee is \$50; \$42 for center members.

Musical Theater For Young People is scheduled for Mondays, Wednesdays and Fridays from June 30 to July 18. Margaret Tyler will instruct at the Old City Hall in Ketchum. Times and fees are: Grades K-1, 9-10 a.m. (\$35; \$32 members); Grades 2-4, 10:15-11:30 a.m. (\$42; \$38 members); and Grades 5-7, 11:45 a.m.-1 p.m. (\$42; \$38 members).

For further information or registration, call 622-9371.

Landscape painting workshop set

HAILEY — The College of Southern Idaho Art Department is traveling north to hold a Landscape Painting Workshop July 7-10 in Hailey.

The class will be taught by Michael Green, CSI associate professor of art. He will give instruction on techniques and concepts of painting from nature using water media.

Students will visit several locations in the Hailey/Ketchum area to paint on site. Emphasis will be placed on how to approach landscape subject matter when working on location.

Because the class will meet each day from 9 a.m. to 3 p.m., students are advised to pack a picnic lunch and bring hats and sunglasses. Slide

talks, filmstrips, demonstrations and critiques will also be part of each day's activities.

For more information and a list of materials needed for the class, contact Florence Blanchard at the Blaine County Community Education Center, 788-2938, or call Green at CSI, 733-9554, ext. 269 or 356.

Magic Valley Dining Guide



THE SWEETEST DEAL AROUND!
"FREEWAY'S SPECIAL"

Prime Rib Sandwich served upon faced on your choice of bread & french fries.

\$4.50

ONLY

TRAVELER'S OASIS
INTERSTATE 84 - EXIT 182 JUST NORTH OF HANSEN BRIDGE
OPEN 24 HOURS. 825-4147 7 DAYS A WEEK

Formerly Frontier Pies SERVED ANYTIME!

SPECIAL! \$2.99

HAM 'N EGGS

2 FRESH EGGS, COUNTRY SMOKED HAM, HASHBROWN POTATOES, BISCUIT & HONEY!

HOT COFFEE TOO!

598 BLUE LAKES RD
IN THE TOWNWOOD
734-9403

Eight ceramists show works

KETCHUM — The Sun Valley Center Gallery is currently exhibiting works by eight contemporary ceramists who will appear at the Sun Valley Center for the Arts and Humanities this summer as visiting or resident artists.

"Clay" exhibits the ceramic pieces of Paul Chaleff, Catherine Hiersoux, Judy Moonells, Anne Perrigo, Sandra Robishaw, John Roloff, Elmer Taylor and Jim Romberg.

New York City artist Judy Moonells is displaying figurative, sculptural pieces that are life-size structures formed from large slabs of earthenware which are shaped, carved and then textured with knives and forks. The figures are elusive and somewhat ambiguous — almost primitive with a sense of the magical.

Sandra Robishaw, an emerging artist also from New York City, is interested in the layering of clay, texture and surface design. Her large, abstract wall pieces are architectural and geometrical with surfaces that are spiraled and textured to create a sense of motion in the shadows.

The gallery is also showing a detailed drawing that serves as a blueprint for California artist John Roloff's large environmental art installations. Roloff is inspired by transformations and marks left on the earth by transitory elements such as volcanoes. He creates steel frames welded into shapes of mountains, ships and fish heads, some as long as 40 feet.

Jim Romberg, director of the center's ceramics department, is showing abstract sculptural and functional raku-fired pieces that are impressive in their angulation and their painterly application of multi-colored glazes.

"Clay" will remain on exhibit through July 7 and is free to the public. The center and gallery is located in the Old City Hall Building at 4th and Main in Ketchum.



Stoneware bottle by Elmer Taylor

Teacher to tour

TWIN FALLS — Lori Head, the daughter of Edna Mae and George Jukich, Twin Falls, has been selected as a choreographer and dance teacher with Extraordinary Students of America.

The touring group, based in California, chooses instructors and students to tour and perform throughout the world. The group will begin rehearsing in New York City, then proceed on a six-week excursion through seven countries in Europe.

Head, who will be creating, directing and producing all the performances given by her group, is a graduate of Boise State University where she taught dance for a number of years. She and her husband are currently living in Pilot Point, Texas, where she teaches at North Texas State University in the dance department.

EXPO 86

ROYAL EXPO TOURS

One week motorcoach tours include:

- Overnight at Paradise Inn, Mt. Rainier
- 3 Day admission tickets to EXPO '86
- City Tour of Vancouver
- Beautiful Vancouver Hotels
- Ferry to Victoria
- Butchart Gardens, Victoria

"SPECIAL" Departure — July 17th
Ask About Our FREE Hotel Package

DESERT SUN TRAVEL • 734-9486
4 WAYS TRAVEL • 734-7805
MAGIC CARPET TRAVELS • 733-1668
CALL TODAY FOR DETAILS!!!

What's your excuse for not cooking tonight?



Bring in this ad and receive **20% off** on any Entree!!!

OFFER EXPIRES JUNE 30, 1986

The Landmark

Hazelton, Idaho

829-5482

OPEN 5:00 TO 1:00
TUESDAY-SATURDAY
SUNDAY
9:30 TO 3:00
CLOSED MONDAYS

Woolworth

VALUES,
OUR
TRADITION

Prices Effective thru Sunday, June 22nd. Quantities Limited to Stock on Hand!

CLEARANCE SALE

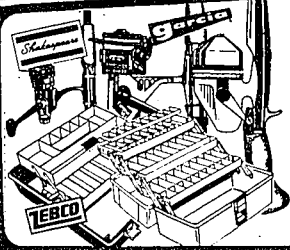

20% OFF
Rods, Reels & Tackle Boxes. Quality brands experts demand. Garcia, Zebco, and more. Reduced in time for a rewarding season ahead.

SELECTION WILL VARY FROM STORE TO STORE



25% OFF

Now 5.99-11.99

reg. 7.99-15.99
Dress-Up or Casual Shirts. Solids, patterns, plain or fancy, poly/cottons, new crinkle looks. 14 1/2-17, S-XL.

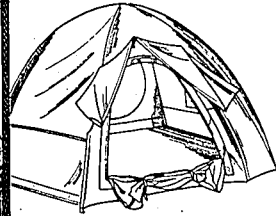

Save 42.99
\$37

reg. 79.99
3-Person Dome Tent. Water repellent nylon taffeta floor and walls, nylon roof & zippered rear window with storm flap. #303. (While quantities last).

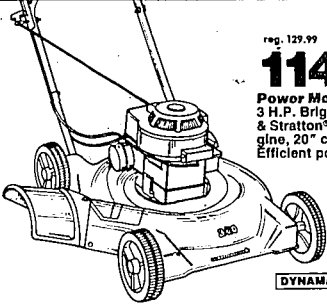

reg. 129.99
114.99

Power Mower. 3 H.P. Briggs & Stratton engine, 20" cut. Efficient power.

DYNAMARK®

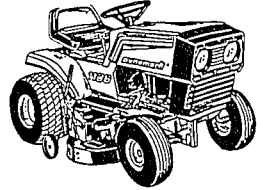

\$949

reg. \$1,099

11-HP Dynamark® Riding Mower. Key start Briggs & Stratton 36" twin blade engine. Rear discharge cutting deck. Heavy duty transaxle with 3 speeds and reverse.

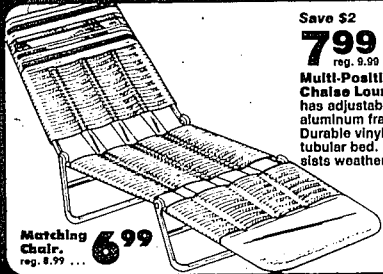

Save \$2

7.99

reg. 9.99

Multi-Position Chaise Lounge. has adjustable aluminum frame. Durable vinyl tubular bed. Resists weather.

Matching Chair. reg. 8.99 ... **6.99**



25% OFF

reg. 11.99-15.99
Ladies' Oversize Blouses and Dresses. Several styles to choose from. Bright prints, solids, striped or polka dot designs.



2.99

Special Purchase Major Label Cassettes. A large collection of artists to choose from.

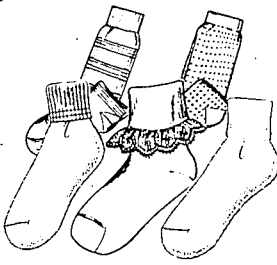

33% OFF

Now 99¢-1.33

reg. 1.49-1.99

Knee-Hi and Ankle-Hose.

New fashion shades to complement summer colors, plus eye-catching lace trims, stylish cuffs and more.



Save 1.49

\$3

reg. 4.99

Short Sets for Boys & Girls.

Several novelty styles to choose from. Girls, size 2T-6X. Boys, size 2T-7.

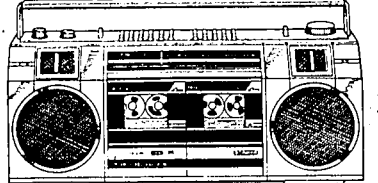

79.99

reg. to 99.99

Sonyo Dual Cassette Recorder. AM/FM radio, auto stop & four speakers. Trim & portable design. #AW200.

SANYO

Soundesign Dual Cassette Recorder. (not illustrated) #4667.



33% OFF

Straw Hats frame the face. Trimmed and untrimmed.



2.99

reg. 3.99

Save \$1
Gerbers® Onesies Underwear. In sizes S, M or L.



Save 75¢

2.24

reg. 2.99

Terry Sunsets.

A collection of bright playtime print & solids to choose from. In cool, fresh styles. Infants' sizes 6-24 mos.



2.50

reg. 3.99

Planters Mixed Nuts. 14.5 oz. tin. 20% more Bonus Pack.

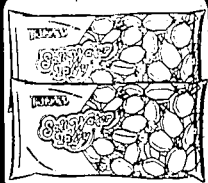

\$1

Special Purchase Salt Water Taffy. A tempting treat, 14-oz.



UP TO **50% OFF**

2 FOR 1.50

reg. to 1.50 ea.

YOUR CHOICE: Novelty BBQ Mitts or Multi-Colored Bolo Rugs.



\$57

reg. 66.99

Save 8.95
Field'n Go Carriage with canopy, basket, foot rest.

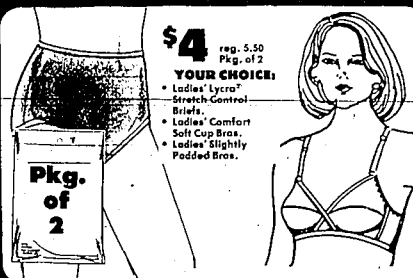

\$4

reg. 5.50

Pkg. of 2

YOUR CHOICE:

• Ladies' Lycra® Stretch Control Briefs.

• Ladies' Comfort Soft Cup Bras.

• Ladies' Slightly Padded Bras.

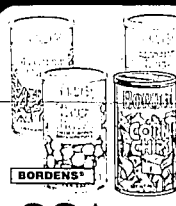

69¢

Special Purchase Borden's® Snacks in 5 to 7 ounce cans. Delicious.



1.59

6-Pk. Coke Products. 6-Pk. 12-oz. cans.

LAYAWAY
Layaway plan for purchases of \$10 or more. Just 10% down (or \$3, whichever is more) including applicable sales tax & service charge (includes merchandise for 90 days). Installment payments must include applicable sales tax.

Mon.-Fri. 9:30 a.m.-9 p.m. • Sat. 9:30 a.m.-6 p.m. • Sunday Noon 'til 5 p.m.
Twin Falls at 705 Blue Lakes Blvd. N.

Charge it!

Comics

Frank and Ernest

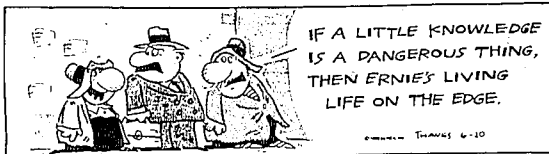

Garfield



Hagar the Horrible

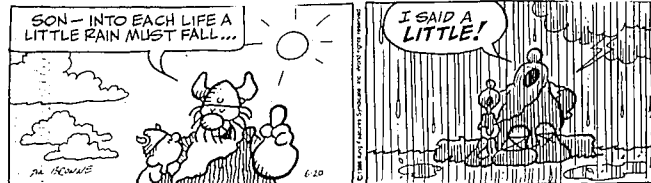

The Born Loser

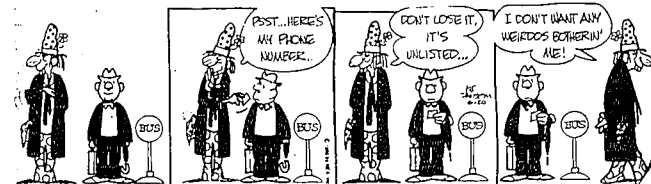

Beetle Bailey

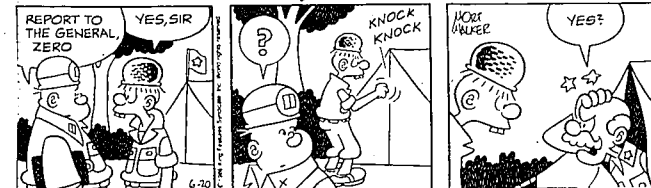

Gasoline Alley

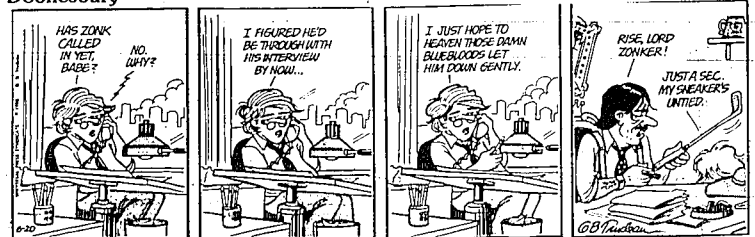

Peanuts



Blondie

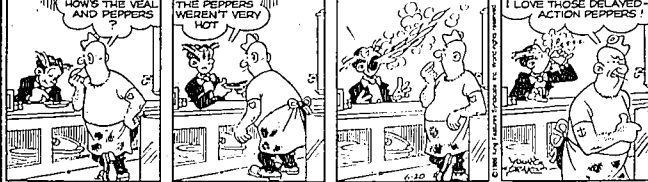

Andy Capp



Wizard of Id

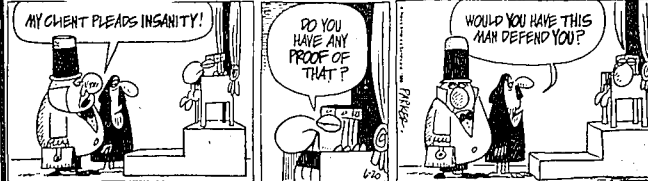

Broom-Hilda



Hi and Lois



ACROSS

- Lordy!
- Get lost!
- Frankie
- Ear part
- Basoball's

DOWN

- Melville novel
- Mork & Mindy's town
- Plane crasher
- Small bad
- Cast a ballot
- Bounders
- Leg part
- Ricochet
- Spring (from)
- Stadium
- Heart throab
- Battering —
- Journey
- Prioms
- Ceslie Caron — role
- Prospero's servant
- Intails
- Kind of movie
- S. Am. range
- Family
- Bartok or Lugosi
- Geze
- Double
- Man — a little —
- Betty Rubbo's neighbor
- Shop purchase
- Old weapon
- Heid's title to
- Legume
- Author
- Sinclair
- Submissive

1986 Tribune Media Services Inc. All Rights Reserved. 6/20/86

Yesterday's Puzzle Solved:

ME, SHE, SHARP, PAIL, ACHES, STAFF, A, B, H, E, L, I, CHARLESTON, THRE, A, H, O, G, A, P, I, T, S, T, H, R, E, A, S, S, I, N, U, A, S, H, O, R, E, A, S, L, E, I, P, C, H, E, Y, E, N, N, E, R, A, I, L, S, C, H, A, R, I, T, O, I, L, B, U, L, I, C, R, A, M, S, A, B, E, D, R, I, C, A, S, H, O, R, E, P, I, E, C, E, O, I, D, I, C, H, O, R, I, D, A, L, L, E, R, E, E, R, Y, M, E, S, S, V, I, O, L, E, T, S, A, L, T, M, A, D, E, D, I, T, T, L, E, R, L, O, C, T, O, R, N, E, L, A, T, E, A, L, I, A, O, L, E, I, A, D, I, E, T, E, R, E, D, Y

Today's Puzzle:

7 Stack of hay

8 In the past

9 Alice's TV boss

10 Sea's luminous circle

11 Amo, emas, —

12 Ore vein

13 Spirit of mind

14 Pathos

15 Sheeplike

16 Knock on the head

17 Amo, emas, —

18 Ore vein

19 Spirit of mind

20 Pathos

21 Sheeplike

22 Knock on the head

23 Amo, emas, —

24 Ore vein

25 Spirit of mind

26 Pathos

27 Sheeplike

28 Knock on the head

29 Ms Burslyn

30 — and true

31 Sharp-eyed to bird

32 Laissez—

33 Long for

34 Writer Harte

35 Ms Rowlands

40 Confused

41 Niagara —

42 Homily

43 Con game

44 Devoured

45 Map

46 — and tide

47 miler

51 Force

52 Sewing machine inventor

53 Boleyn

54 Lectern

56 Bad cold

57 Circuit

58 Soleick

L.M. Boyd
What's what

Ask your family historian what killed two-thirds of the white population of Memphis, Tenn., in 1878.

Yellow fever, the worst such outbreak in U.S. history. Current generations had not been familiar with the threat of plagues until AIDS showed up. But earlier generations knew. When they read how great chunks of population were demolished by disease, they were saddened, but not surprised. Intermittent wipeouts were the norm.

We know whether it's funny, but nobody knows exactly how what's funny triggers the bodily mechanisms of laughter.

At hand is a note from a dieter who says she couldn't lose weight until she gave up silverware and ate with nothing but chopsticks.

BIOGRAPHY

Q. More biographies have been written about Abraham Lincoln than

Daily Horoscope

GENERAL TENDENCIES: A peculiar day with many changes taking place to confuse you. You are feeling held down, but dramatic events happen later to offer you new opportunities.

ARIES (March 21 to April 19): Novel activities are in the agenda today but are apt to have a slow start; afterwards, go great guns! Make new friends.

TAURUS (April 20 to May 20): You may feel that the one you love is not really devoted, but if you act kindly, you can soon get excellent response.

GEMINI (May 21 to June 21): A partner could be unreasonable in the morning, but careful handling later brings the right results.

MOON CHILDREN (June 22 to July 21): You may feel that you are dragging along with your work and are not reaching your aims, so get your finest talents operating.

LEO (July 22 to August 21): Be charming with others since there may be a delay in plans you had made, and don't get flustered.

VIRGO (August 22 to September 21): Be poised at home and handle difficult situations there very wisely. Invite persons in who are the

about anybody else on earth, right?

A. Almost right. Lincoln is No. 2. Napoleon is No. 1.

Q. How many nations occupy Antarctica?

A. Fourteen countries have a combined total of 52 scientific stations there.

Q. What's the most common sort of prodigy?

A. A boy gifted in music.

Q. What's the average temperature of the universe?

A. Three degrees above absolute zero.

TRAFFIC COLORS

Q. You're highly observant, are you? All right, traffic signs now come in five coded colors. Green permits... Yellow warns. Red proclaims. What do blue and orange signify? You'll remember as soon as I tell you. Blue indicates motor services. Orange means construction.

Q. Bees shed hair, birds shed feathers. Settle a barroom bet. Do fish shed scales?

A. No, sir. Clink!

Our Language man is counting ways to pronounce "u." He has seven, so far, as in: busy, bury, thud, beautiful, burr, bull and buy. Missed any?

Two out of three stolen cars get into that condition at night.

South Dakota's town of Lead rhymes with feed.

LIBRA (September 23 to October 22): Plan how best to handle desk work and correspondence and then tonight you can plow right through it.

SCORPIO (October 23 to November 21): In the morning you are concerned with monetary affairs and later you can find new ways of adding to your abundance.

SAGITTARIUS (November 22 to December 21): You may feel thwarted in gaining your personal aims early in the day, but then change your attitude and all works out.

CAPRICORN (December 22 to January 20): Plan how to get rid of a tiresome matter in the morning, and later a new attitude will bring success with it.

AQUARIUS (January 21 to February 19): Contact long-time friends of much experience and gain their assistance in the morning.

PISCES (February 20 to March 20): Plan how to gain more prestige in the outside world. Do something thoughtful for bigwigs and gain their favor.

IF YOUR CHILD IS BORN TO DAY ... he or she will have a fine mind but should be taught to use it in constructive channels and plow in through any subject or project with determination and then this can become a remarkably successful life.



Christ (Bob Nelson), center, heals a leper in a scene from the premiere of 'The Light of the World' last summer on The Mainstage at Promised Valley Playhouse in Salt Lake City

Promised Valley Playhouse plans a summerful of plays

SALT LAKE CITY — More than 20,000 tourists and residents last summer saw the premiere of an unknown spiritual production called "The Light of the World" at Promised Valley Playhouse, an elegant, restored Victorian theater located in the heart of Salt Lake City.

With the hope of attracting double that number of viewers, the playhouse will revive its production of "Light," introduce a new Book of Mormon drama and produce two musicals, two one-man shows and a concert musical of the perennial favorite, "Promised Valley," all as part of its Summer Theatre Festival, which runs through Aug. 30.

"This is the year of 'See America,'" says Joanne Parker, artistic director of the 578-seat Mainstage. "There's a strong emphasis on staying home and seeing what our beautiful land has to offer. The playhouse's Summer Theatre Festival is an invitation to all tourists to visit Salt Lake City. For any tourist, it's a chance to see something new and fresh about America."

Don Oscarson and Maughan W. McMurder's "City of Joseph," a scaled-down version of the Nauvoo pageant that tells the story of Nauvoo, an early Mormon settlement, in song and dance, is currently running and will continue through July 12 in the 100-seat Little Bowers on the third floor of the Playhouse.

Directed by Michael J. Bennett, it will run Mondays at 6 p.m. and Tuesdays through Saturdays at 7:30 p.m., with a 2 p.m. matinee on Saturdays.

"The Ark," a brand-new musical based on the Bible story of Noah and the flood, will premiere June 27-Aug. 30 in Flum Alley, a 50-seat environmental family theater located just north of the box office. Written by Michael McLean and Kevin Kelley, the high-energy musical runs Mondays through Fridays at 4 p.m., and Saturdays at 2 p.m.

"The Light of the World" and "One Fold, One Shepherd," both by Joanne Parker and Madelyn Larsen, will run every other day on The Mainstage, July 1-Aug. 30. Using state-of-the-art sound, dramatic and lighting effects, the productions portray powerful, spiritual events from the Bible and Book of Mormon.

"The Light of the World" presents the role of the Savior from the Creation through the Second Coming. "One Fold, One Shepherd," a Book of Mormon dramatic scriptural presentation of the Savior's visit to the American continent, is a new play with music by film composer Merrill Jensen.

"The Light of the World" runs Mondays at 6 p.m., Wednesdays and Fridays at 7:30 p.m. and Saturdays at 4 p.m. "One Fold, One Shepherd" will play Tuesdays, Thursdays and Saturdays at 7:30 p.m.

Indian riches go to Seattle

SEATTLE — "India: A Festival of Science," will come to the Pacific Science Center July 1-Oct. 31 on its nationwide tour.

The exhibition is part of the multi-faceted 18-month "Festival of India" tribute to Indian art, music, drama, dance, films, crafts, science and technology consisting of over 500 events taking place in 90 U.S. cities in 30 states.

The exhibit examines the historic and contemporary contributions and activities of India in such fields as mathematics, astronomy, medicine, chemistry, nuclear power and space technology.

The Pacific Science Center is located at the Seattle Center on 2nd Avenue North between Denny Way and John Street. For further information, call Pamela Dorrance, marketing supervisor, (206) 443-2881.

A Times-News classified Will promote your garage sale better than any medium Phone 733-0626

Utah Arts Festival celebrates 10th

SALT LAKE CITY — The popular Utah Arts Festival, June 25-29, held in downtown Salt Lake City at Triad Center, will be even more celebratory this year as festival-goers join in the commemoration of the event's 10th anniversary.

The lineup of international and national visual and performing artists include the experimental jazz of the Soviet Union's Ganelin Trio and environmental artist Dale Eldred's large-scale light sculptures that can be seen up to 20 miles away.

Other events are the world premiere of the modern dance piece, "Ten Plus Twenty," created by the Repertory Dance Theatre; doo wop rockapella by the Nytons from Toronto, the French folk music of Lo

Jal and the Grammy Award-winning Queen Ida and the Bon Temps Zydeco Band from Louisiana.

Attractions also include performances by the Utah Symphony, Ballet West and the Ririe-Woodbury

Dance Company. Video artist Bill Viola will introduce his installation, "Reasons for Knocking at an Empty House," and conceptual artist Andrew Krasnow will bring in his "Knock! Knock!" work, a collection of 25 doors.

BSU publications in touring exhibit

BOISE (AP) — Two books published by Boise State University's Ashsha Press are being included in a special exhibit bound for two European book fairs, including one in Frankfurt, Germany, that's the largest in the world.

BSU officials said the National Endowment for the Arts has selected "Aqua Negra" and "Flights of the Harvest Mare" for inclusion in the exhibit entitled "New American Writing."

A total of 100 books were chosen for the exhibit, which will also appear at a book fair in Liber, Spain, the university said.

Ashsha Press publishes books of poetry written by Western authors.

Actor James Arrington will present his one-man show, "Here's Brother Brigham," on The Mainstage July 23 and 24 at 7:30 p.m. Arrington researched and wrote the play by reading 30,000 of Brigham Young's personal letters, seven biographies, countless sermons and numerous autobiographical writings.

What emerges is a life-size, moving portrayal of Brigham Young that has been staged nationally and internationally over the past decade.

A concert version of Crawford Gates' and Arnold Sundgaard's musical, "Promised Valley," performed with soloists and a 40-piece orchestra, will run on The Mainstage July 25 and 26 at 7:30 p.m.

"J. Golden," another one-man show written by Arrington, will run in the Little Bowers July 28-Aug. 23. Bruce Ackerman, now a New Jersey resident, will return to Salt Lake City to recreate the role of J. Golden Kimball, considered one of the most colorful figures to sit in the high councils of the LDS Church.

"J. Golden" will run Mondays at 6 p.m. and Tuesdays through Saturdays at 7:30 p.m. with a 2 p.m. matinee on Saturdays.

Ticket prices for festival productions range from \$3 to \$5. A Family Night Special is offered for the 6 p.m. Monday performances on The Mainstage and Little Bowers, and there are reduced children's prices and group discounts. The Mainstage family pass costs \$20 for families (\$3 for each additional person after six members). The price for the Little Bowers family ticket is \$25 (\$4 for each additional person after six members). For "The Light of the World" and "One Fold, One Shepherd," children must be at least six years of age to attend.

For information and tickets, call the Promised Valley Playhouse box office, (801) 364-5677. The theater is located at 132 S. State St., Salt Lake City.

SUMMER BICYCLE SALE

OLYMPIA 27-INCH 10-SPEED
\$89⁹⁹

'89** Fully Assembled and Adjusted
5 year frame warranty, slaved frame, 3pc. crank assembly, Center pull brakes, Stem shifting lever, 26 spoke wheels.

OLYMPIA 16 OR 20-INCH BMX BIKES
\$79⁹⁹

'89** Fully Assembled and Adjusted
Raised and extended crank, reinforced frame with 5 year warranty. Complete set safety pads.

In Carton

Pedersen's

Main of 3rd East, TWIN FALLS In the Burley Mall, BURLEY

RCA DIGITAL COMPACT AUDIO/VIDEO RECEIVER

- Fully functional Remote Control
- 50 w/ch Power Output
- Built in 5 band EQ

Mfg. List \$559

NOW \$399

PIONEER 2100 SYSCOM

- 70 w/ch Non-switching AMP
- Quartz PLL Tuner
- Fully Auto-Tunable
- Auto Reverse Deck w/Dolby B/C
- 10' 3 Way Speakers
- Includes Audio Cabinet

Mfg. List \$1195

NOW \$899

GET A \$200* 10-SPEED FREE WITH PURCHASE of Pioneer 2100 Syscom

MARANTZ X500 Designer Series DIGITAL REMOTE CONTROL

- 100 w/ch Digital Audio-Video AMP
- Digital Synthesis Tuner
- 3 Mode Auto Reverse Deck Turntable
- Automatic Linear-Tracking
- 15' 3 Way Speakers
- The Incomparable Sound of Marantz

Mfg. List \$1795

NOW \$1295

PIONEER PD-M6 MULTI-PLAY CO PLAYER

Holds 6 CD's

Choose up to 32 selections in any order from 4 compact discs

- Fully Functional Remote Control
- Random Play Feature
- Disc Stabilizer
- Auto Program Memory
- Linear Servo Tracking System with 3 Beams Laser Pick-up
- 4 Repeat Modes

Mfg. List \$499

NOW \$349

THE HEAT IS ON!

ULTIMATE TURBOS

Designed For Digital and Straight High Quality Mobil Audio Systems

Mfg. List \$429

NOW \$259

FOR ALL PICKUPS, HATCHBACKS, VANS, BOATS, RV's, ECT, And Any VEHICLE

Where EXCELLENT BASS SOUND IS DESIRED!

*2 Ea. 8" Polypropylene Woofers
1 Ea. 10" Positive Radiator
2 Ea. 2"x6" Piezo Electric High/Mid-Range Horns

CLARION 6"x9" Multiaxial Speaker

High Compliance Woofer
Dynamic Mid-range Tweeter

Peak Capacity 120 wts.
Maximum 80 wts.
Continuous 40 wts.
Impedance 4 ohms
Efficiency 94 db.

Mfg. List \$169.95 pr.

NOW \$99.95

With Hot New Savings From Some of The Biggest Names in Car And Home Audio — Now Until June 30, 1986.

HOME APPLIANCE & TV

RCA

571 BLUE LAKES BLVD. N. (Corner of Blue & Blue Lakes Blvd.) 224-3312
OPEN MONDAY THROUGH SATURDAY 9:00 A.M. - 6:00 P.M.

PIONEER 6"x9" MAXIAL 3 WAY SPEAKERS

120 w/ch Maximum. Recommended for DIGITAL MUSIC SOURCES.
Impedance - 4 ohms. High Sensitivity.

Mfg. List \$189.95 pr.

NOW \$149.95 pr.

PIONEER HI-POWER AMP

60 w/ch
30-20,000 HZ
0.3% THD

Mfg. List \$289.95

NOW \$199.95

CLARION GRAPHIC EQ AMP

5 Band Eq.
30w/ch

Mfg. List \$139**

NOW \$99.95

PIONEER AM/FM CASSETTE

WITH "NEW" SL HEAD

- 24 Presets
- Seek Tuning
- Supertone III
- Auto Reverse w/ Rotary Thrust Head
- Key-off Pinchroller Release
- Tape Slack Canceller
- 4 Way Fader
- SL Head
- LCD/Clock Display

Mfg. List \$349.95

NOW \$229.00

CLARION 8600 AM/FM CASSETTE

WITH AUTO STORE

- 18 Presets
- Auto Reverse
- 4 Way Fader
- LCD Display
- Music Search
- Metal Tape
- Seek Tuning
- Separate Bass-Treble
- MAGI-TUNE
- Presets Scanning

Mfg. List \$349.95

NOW \$259.00



Go Big-O

DURING OUR ANNIVERSARY SALE THURSDAY-FRIDAY-SATURDAY, JUNE 19-20-21

FREE



"Guru" Tent

to be given away at each of the Magic Valley Big-O Stores during our **ANNIVERSARY SALE** Thursday - Friday - Saturday, June 19-20-21 Tents formerly owned by the Bahagwan Shree Rajnoosh Heavy Duty Canvas, 10x14 with rubber floor & tent fly

Falls Brand **Hot Dog and a Pepsi — 25¢**
FREE Pens — Balloons
Key Rings
No Purchase Necessary

Pickup, Camper, RV, Motor Home



| Hiway Design | Price |
|--------------|------------------|
| 700-15 | 55 ⁵⁹ |
| 750-16 | 68 ⁷⁹ |
| 800-16.5 | 64 ⁸⁴ |
| 875-16.5 | 73 ⁹⁷ |
| 950-16.5 | 85 ³³ |



| Traction Design | Price |
|-----------------|------------------|
| 700-15 | 61 ²⁰ |
| 750-16 | 79 ⁹⁶ |
| 800-16.5 | 76 ⁵⁴ |
| 875-16.5 | 86 ⁹⁴ |
| 950-16.5 | 99 ¹¹ |

Includes Mounting & Balancing



Big-O Euro

36⁷¹

| Size | Sale Price |
|------------|------------|
| 155SR12 | 38.59 |
| 165SR13 | 42.15 |
| 165SR15 | 48.59 |
| 175/70SR13 | 43.18 |
| 185/70SR13 | 47.77 |
| 185/70SR14 | 53.19 |

MANY MORE UNADVERTISED SPECIALS
There is something for everyone at BIG-O During Our ANNIVERSARY SALE
JUNE 19-20-21

All-Season Radials

Big-O Made a Huge Purchase of These Tires So You Can Get Them at These Low Prices
Not Seconds or Blem
Aggressive All-Season Tread White Walls

Size 155/80R13
Tread Design May Vary

33⁹⁵

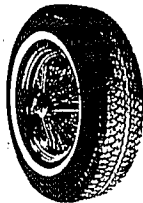

| | |
|-----------|-------|
| 165/80R13 | 35.95 |
| 175/80R13 | 36.95 |
| 185/80R13 | 38.95 |
| 195/75R14 | 40.95 |
| 205/75R14 | 43.95 |
| 215/75R14 | 43.95 |
| 225/75R14 | 47.95 |
| 205/75R15 | 46.95 |
| 215/75R15 | 47.95 |
| 225/75R15 | 51.95 |
| 235/75R15 | 53.95 |

Plus Exchange

Free Prices

Balloons

All Big-O BRAND TIRES ON SALE FREE

Valve stem • computer spin balance • rotation/rebalance every 5,000 miles, flat repairs, air checks. Ask about our FREE road hazard warranty to 3/4" tread at over 250 dealers in the U.S.A.
• Compacts • 4 Wheel Drive
• Full Size Cars

Tires

Whools

Alignment Combination

Front Wheel Alignment
Plus Spin Balance & Rotate 4 Tires

\$25⁹⁵

Most Cars



Complete Quality Service at Big-O

Shocks - Brakes - Alignment
MacPherson Struts - Service
Our Commitment to Excellence!

Big-O Brand Big Foot Radial

81⁷⁵

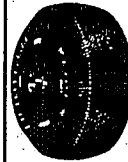

| Size | Price |
|-------------|--------|
| LT195/75R14 | 88.21 |
| 27x8.5R14 | 104.82 |
| P235/75R15 | 89.99 |
| LT215/75R15 | 107.36 |
| 31x10.5R15 | 133.07 |
| 31x11.5R15 | 140.10 |
| 33x12.5R15 | 150.85 |

Plus F. E. Tax

Big-O Radial

Big Foot XT

31x10.5R15

130³⁴

Plus F. E. Tax



Big-O All-Season Tread Big Steel LT

For Pickups & 4-Wheel Drives
750R16 8-Ply Tubeless



| Size | Price |
|------------|-------------------|
| 800R-16.5B | 96 ⁵⁴ |
| 875R-16.5B | 103 ⁰⁴ |
| 950R-16.5B | 117 ⁸⁷ |

Plus Exchange

Shocks

Heavy Duty

\$9⁹⁵

Installation Available

Modular

Chrome, Gold/Chrome, Black/Chrome

Custom Wheels



White Spokers

15x7
4 for 89⁹⁵

Chrome Spoker

14x6 **36⁹⁵**

| | |
|-----------|-------|
| 14x6 | 38.95 |
| 15x7 | 37.95 |
| 15x8 | 39.95 |
| 16x7 | 37.95 |
| 16.5x8.25 | 62.95 |

Free Mounting

Exchange • Accessories Extra



Where Service Is A Fact,
Not Just A Promise!

Prices Available at Your Local Big-O Dealer Thru June 19-20-21, 1986

Twin Falls

211 West Addison
Phone 733-6373

Buhl

Truck Lane & Main
Phone 543-4328

Burley

219 East Main
Phone 678-2411

Jerome

501 South Lincoln
Phone 324-4389

Paul

25 West Ellis
Phone 438-5418

Rupert

724 Scott
Phone 436-9321



The Times News

TV

June 20 to June 26, 1986

Ford's Theatre gets stars' salute - Page 2

On the cover

Salute to Ford's Theatre shines with stars in a 'really big show'

By ANDREW J. EDELSTEIN

"The Kraft All-Star Salute to Ford's Theatre" (airing Wednesday, June 25 on CBS) seems to offer something for every artistic taste — except for those who enjoy heavy-metal or early madrigal music. The special, hosted by Richard Chamberlain and Jaclyn Smith, features pop singers, jazz singers, dancers, magicians, comedians and pianists.

It's the type of really big show that used to dominate prime-time TV — but has virtually vanished from the airwaves.

"Variety shows really don't work anymore," concedes Joe Cates, producer of the salute, who has produced more than 200 network specials. "But this kind of show is more than a variety show. It's an event. Events work."

And this is an event. The gala was taped June 8 in front of a black-tie audience at Ford's Theatre, the restored Washington, D.C., theater where President Lincoln was assassinated in 1865. The money from the gala (tickets cost \$5,000) funds future presentations at the theater. President and Mrs. Reagan as well as several members of Congress were in attendance. Guests also met President Reagan at a White House reception.

The performers were paid scale, but costs escalated. For instance, Tommy Tune and Sandy Duncan did not want to perform material from their Broadway smash "My One and



JACLYN SMITH
Co-hosts gala fundraiser

Only," because they had performed a similar routine on another recent network special. So Cates hired choreographer Tad Tadlock, who created an original routine.

Among the other highlights: Co-host Richard Chamberlain will read a soliloquy from Lincoln; Joel Grey performs George M. Cohan songs as well as a tune from "Cabaret"; Paul Anka sings a specially written (by Sammy Cahn) version of "My Way" that Cates said "reflects the even-

ing's circumstances."

(Other acts include comedians Louis Anderson and Freddy Roman, pianist Victor Borge, country singer Sylvia, magician Lance Burton, ballet dancer Cynthia Harvey (and her partner Ross Stretton), dancer Fernando Bujones and members of the cast of "The Hot Mikado," the current stage production at Ford's.

Despite these disparate performers, Cates runs the taping without interruptions.

"I run it like a live show," explains Cates, who is producing his third Ford's Theatre gala. "Of course, you can't use certain lighting or certain scenery. But I do not do takes. The audience is treated well. I'm very big on that. We shoot the actual performance."

COVER PHOTO: Richard Chamberlain will co-host with Jaclyn Smith a "command performance" when a cavalcade of stars entertain before a black-tie audience of influential business and political leaders on "The Kraft All-Star Salute to Ford's Theatre" Wednesday at 7 p.m. on KBCI-Boise, KID-Idaho Falls, KMVT-Twin Falls and KSL-Salt Lake City.

Games go global

Los Angeles Times

HOLLYWOOD — The Goodwill Games, which Turner Broadcasting Systems is mounting July 5-20 in Moscow, is a step toward global telecasting: The Olympics-style athletic competition will be broadcast throughout the world via deals arranged by TBS, which holds the rights to the events.

"It's going to look like the Olympics, sound like the Olympics; the only difference is it's not called the Olympics," Turner said.

Though the event, as a commercial programming venture, may incur "a moderate loss" in its first outing, Turner said that he's positive it will recoup those losses in 1990.

RENT TO OWN

TELEVISIONS



COLOR

T.V.

Rent To Own

Starting at **\$8.00**
Per Week

VCR'S



SHARP VCR'S

With wire or wireless remotes.

Rent To Own

Own
\$10.00 and
\$12.00
Per Week

APPLIANCES



REFRIGERATORS

Rent To Own

Starting at **\$7.00**
Per Week

CLEARANCE & RENTAL

CENTER

733-7111

(Across from our main store)
152 2nd Ave. North, Twin Falls

Cain's

Also, Sofas,
Dinettes,
Refrigerators,
Dishes, Washers,
Lamps, Chairs, Etc.

Collins party to French fracas

By ROBIN ADAMS SLOAN

Q. What's this about Joan Collins getting into trouble with French police for hitting another woman in a restaurant? — H.J.

A. What really happened is open to interpretation. It seems that Joan's husband-manager, Peter Holm, did get into a fracas in a tres cher restaurant in the French Riviera recently. But Holm was the one involved, not Joan. Seems the couple ran into movie producer Elliott Kastner, who was also dining at the restaurant. Holm apparently confronted the producer about some financial matter regarding a film Collins once worked in years ago. An argument ensued. According to Kastner, Holm pulled the chair out from under him, causing the producer to fall unceremoniously to the restaurant's well-carpeted floor.



JOAN COLLINS
Husband confronts producer

Q. We heard that Brooke Shields is having some heavy personal pro-

blems. Is it serious? — P.D.

A. Career problems plus personal setbacks, apparently on the boyfriend front, are taking a toll on the 21-year-old Shields. At a recent testimonial dinner for Bob Hope — who is a genial, grandfatherly figure to Brooke — she broke down in tears as she delivered her toast. She confessed to an astonished, blue-chip crowd that she was going through a difficult time at the moment. I'll keep you posted on how Brooke makes out.

• See GOSSIP on Page 5

Movie Ratings

| | |
|-----------------------|------|
| Outstanding | ★★★★ |
| Excellent | ★★★ |
| Very Good | ★★★ |
| Good | ★★ |
| Not Bad | ★ |
| Fair | ★ |
| Poor | ★ |

Cable television guide conversion table

If you are a subscriber to King Cablevision, look for black station symbols or bold movie channel abbreviations:

- ① KBCI-Boise (CBS)
- ② Nickelodeon
- ③ KAID-Boise (PBS)
- ④ CNN-Atlanta (24-hour news)
- ⑤ KIVF-Boise (ABC)
- ⑥ KTUV-Boise (NBC)
- ⑦ WTBS-Atlanta (Independent)
- ⑧ KTRV-Boise (Independent)
- ⑨ CBN (Christian)
- ⑩ KMVT-Twin Falls (CBS)
- ⑪ ESPN (24-hour sports)
- ⑫ Disney Channel
- ⑬ Nashville Network
- ⑭ USA Network
- ⑮ KUTV-Salt Lake City (NBC)
- ⑯ MTV (24-hour music video)
- ⑰ C-SPAN (Congress)
- HBO Home Box Office
- SHOW Showtime
- ⑱ KSL-Salt Lake City (CBS)
- ⑲ Discovery (Non-Fiction)

If you are a subscriber to another area cable system, look for white station symbols listed under the column for your community. Stations available that are not listed above include:

- ① KID-Idaho Falls (CBS)
- ② KTVX-Salt Lake City (ABC)
- ③ KPVI-Pocatello (ABC)
- ④ KUED-Salt Lake City (PBS)
- ⑤ KIFI-Idaho Falls (NBC)
- ⑥ WGN-Chicago (Independent)
- ⑦ KGSL-Pocatello (PBS)
- ⑧ Lifetime (Health/Fitness)
- ⑨ ARTS (Fine arts)
- (SHOW) Showtime
- CIN Cinemas
- (TMC) The Movie Channel

| | Twin Falls Jerome/Wendell Gooding/Flier Kimberly/Hansen | Burley/Rupert | Ketchum/Sun Valley | Hagerman | Shoshone | Hazelton | Richfield | Castletown | Buhl |
|------|--|---------------|--------------------|----------|----------|----------|-----------|------------|------|
| ① | 2 | - | 2 | 8 | 2 | - | - | 8 | 2 |
| ② | 10 | - | 10 | - | - | - | - | 10 | 4 |
| ③ | 4 | - | 4 | 10 | 4 | - | - | 10 | 13 |
| ④ | 5 | 17 | 4 | 22 | - | - | 13 | 12 | 6 |
| ⑤ | 6 | - | 8 | 13 | 6 | - | - | 7 | 7 |
| ⑥ | 7 | - | 7 | 7 | 7 | - | - | 21 | 10 |
| ⑦ | 8 | 12 | 9 | 18 | 13 | 12 | 12 | 12 | 12 |
| ⑧ | 9 | - | - | 12 | - | - | 9 | 10 | 11 |
| ⑨ | 11 | 9 | 12 | 20 | 10 | 9 | 10 | 11 | 11 |
| ⑩ | 12 | 11 | 11 | 11 | 11 | 11 | 11 | - | - |
| ⑪ | 12 | 13 | 18 | - | - | - | - | - | - |
| ⑫ | 14 | 20 | 14 | - | - | - | 9 | - | 11 |
| ⑬ | 15 | 10 | 21 | - | - | - | - | - | - |
| ⑭ | 16 | 21 | - | 21 | 9 | - | - | - | - |
| ⑮ | 17 | 2 | - | - | - | - | - | - | - |
| ⑯ | 18 | 18 | 16 | - | - | - | - | - | - |
| ⑰ | 20 | 15 | 25 | - | - | - | - | - | - |
| ⑱ | 21 | 3 | 61 | - | - | - | - | - | - |
| HBO | 22 | - | - | - | - | - | - | - | - |
| SHOW | 23 | 5 | - | - | - | - | - | - | - |
| ⑲ | 24 | - | - | - | - | - | - | - | - |
| ⑳ | - | - | - | - | - | - | - | - | - |
| ① | - | 10 | 3 | - | - | 3 | - | - | - |
| ② | 4 | - | - | - | - | - | - | - | - |
| ③ | 6 | 6 | - | - | - | 6 | 6 | - | - |
| ④ | 7 | - | - | - | - | - | - | - | - |
| ⑤ | 8 | - | - | 8 | - | - | - | - | - |
| ⑥ | - | 15 | 18 | - | - | - | - | - | - |
| ⑦ | - | 10 | - | - | - | 10 | - | - | - |
| ⑧ | - | 16 | 17 | - | - | - | - | - | - |
| ⑨ | - | 17 | - | - | - | - | - | - | - |
| ⑩ | - | 16 | 17 | - | - | - | - | - | - |
| ⑪ | 22 | 20 | 2 | 2 | 2 | 2 | 2 | 2 | 3 |
| ⑫ | 23 | 20 | - | - | - | - | - | - | - |
| ⑬ | - | 22 | 3 | 15 | 15 | 3 | 3 | 21 | - |

Soap Opera Scene

'Days of Our Lives' star thanks Collins for richer female roles

By JOHN GOUDAS

If Peggy McCay of "Days of Our Lives" wins a Daytime Emmy next month as Lead Actress she will thank Joan Collins.

Peggy would even name a street after Joan Collins if Beverly Hills officials agreed. Because of Joan's "Dynasty" reign, middle-aged actresses acutally get phone calls these days, and auditions.

"Joan proved women over 40 can be sexy and exciting," Peggy declares. "Writers are catching on."

Last fall Peggy caught on as Caroline Brady for "Days," mother of Roman and of Bo. Used to playing sweet moms, especially understanding moms, Peggy hooked a tiger in Caroline. Fans soon learned that Caroline had been married to nasty Victor Kiriakos. She was his lover, then his wife, then after a split, a lover again. Just lately Caroline tells Bo his real Poppa is Victor. Bo has a fit, and never wants to see Mom again.

Things were quite different for Peggy as editor Mason Adams' wife Marlon Hume during a six-year run of "Lou Grant." Dutiful Marlon knew her place. In one episode Marlon goes to work and thoroughly enjoys the outside life. But she quits when work infringes upon domestic bliss.

For a final line, Marlon tells her husband she is giving up the job because she loves him. Peggy inserted a note of regret in her reading, a waspish tone that brought down the bosses. Housewives would be indignant over the hint that perhaps a job was a pleasure. Peggy did the line over. Joan Collins would have booted.

Brought out from New York for Warner Brothers back when Jim Garner rode through studio streets looking for his "Maverick" posse, Peggy McCay is a stayer, a 30-year survivor.

The McCay span stretches from "Marcus Welby" to this spring's Jim Garner-Sally Field movie, "Murphy's Romance." From the pilot "Night Court" to "Streets of San Francisco."

Miss Mccay has matured gracefully is another way to put it, managing to hang in the 1.8 percent of actresses who earn a good income.

"I've lived off residuals," Peggy says with a laugh. She also fought



PEGGY McCAY
Hooked a tiger in Caroline

within the Screen Actors Guild for more employment of women, a losing cause since she was told to fight on her own.

Peggy has always rolled with the punches, kept her sanity. "I learned early," she notes. "In a New York theater run of 'Uncle Vanya' with Franchot Tone, we were all going crazy after 200 performances. I got a Joe Palooka knock-em-down doll, and punched out my anger. A welcome-home recording with happy barking dogs is also a great soother."

Still on the beat, riding high with an Emmy nomination, McCay is one of Hollywood's lucky elite. Yet she must audition for the rest of her life, lining up with everybody else since her jam-packed list of credits means nothing to the younger generation of producers.

So Peggy bites her tongue, and reads with the new kid in town. It's part of the deal, and it led to juicy Caroline, and a possible Emmy.

From the voice-box, Peggy is called to work on "Days." "If you'll excuse me," Peggy says sweetly, "I'm going out to shoot Victor."

CHANNEL CHATTER:

It seems that every month or so, NBC's "Santa Barbara" hires an actor, usually a familiar soap face from another show. This month's newcomer is Justin Deas, who

delighted fans for many years on "As the World Turns" playing Tom Hughes. Deas now plays Keith Timmons and may find himself involved in a love triangle. Also new to "Santa Barbara" are Marie-Alise Recanser as Alice, a patient at the sanitarium, and Jane Sibbett in the role of Jane Wilson, an employee at Ted's radio station. Fans may remember Recanser, who once played Paris Kent on "Capitol."

Two shows are celebrating anniversaries this coming week. TV's longest running soap, "Search for Tomorrow," will air its 9,000th episode on Thursday. An impressive milestone in TV history. On the other hand, ABC's "Loving" will have its third year anniversary on Friday, June 27. The show has gone through numerous changes from its early episodes, until it found the right mix of characters and plotlines.

PLOT PORTENTS:

Cass has a lot of explaining to do to a very upset Kathleen on "Another World." Peter has a confrontation with Michael. Brittany is distressed that she might not be able to support her newborn son.

Max has evidence that could place both Roger and Maggie behind bars on "Ryan's Hope." Diana asks to many questions and Frank sends her on a vacation. As a way to protect Ryan, he throws her out of the apartment.

Palmer wants to take an early retirement and turn the company over to Ross on "All My Children." Erica and Brooke fly to South America and smell a possible hijacking attempt. Marlon makes a play for Wade.

Herb wins the D.A. election and his first case is Stan's death on "One Life to Live." Mitch vows revenge against Tina. Cord learns that Clint is his father. Tina tells Richard about her past with Cord.

Lloyd, still in the hospital, adds a codicil to his will on "Search for Tomorrow." Hogan is upset that Patty is seeing Quinn. Wilma and Stu make plans together.

Gossip

• Continued from Page 3

Q. Didn't his London jail stay on cocaine charges really sink Stacy Keach's career? — B.Y.

A. Hardly. Following his release from the slammer in England, Stacy has managed quite well. A masterstroke was the public recanting he engaged in, conceding his drug problems and warning youngsters about them. This redeemed him in the Hollywood production community's eyes and gave the actor some pretty classy TV shows to narrate and host. Also, the "Mike Hammer" series wasn't killed as expected. Personally, Keach is in fine shape. He's getting married again, this time to Polish actress Maigosa Tomassi, his co-star on a "Mike Hammer" episode. Big surprise is that before the wedding, the couple was invited to the White House to attend a state dinner. Not bad for an ex-jailbird.



STACY KEACH
Recanting redeemed him

Q. It seems that every time we see a big social event in the press, we

see Grace Jones somewhere near the center of the action. Is she that much of a publicity hound? — C.W.

A. Actress and former disco queen Jones knows well the value of publicity, especially for one with unusual talents. Grace also has a way of making incidental friends, which helps. She and Arnold Schwarzenegger became pals while making the second "Conan" flick. That's why she turfed up on the arm of Andy Warhol at his wedding to Maria Shriver. Jones is also big at gracing high-tone fashion shows and world film festivals such as the one in Cannes, where I recently spotted her. Grace seems willing to put up with anything as long as her photo is taken and her name is correctly spelled.

Have a question? Write to Robin Adams Sloan, 235 East 45th Street, New York, N.Y. 10017.

RICHARD N. GARIEPY

ATTORNEY AT LAW

ACCIDENT AND INJURY CASES WORKMEN COMPENSATION CLAIMS

- AUTOMOBILE ACCIDENTS
- INSURANCE CLAIMS
- ON JOB INJURIES
- MOTORCYCLE ACCIDENTS
- ACCIDENTAL DEATH
- FAULTY PRODUCTS
- ACCIDENTS OF ALL KINDS

FREE CONSULTATION

NO ATTORNEY FEES UNLESS MONEY RECOVERED

Call 733-4787 or TOLL FREE 1-800-821-7349

Suite 1020 Blue Lakes Office Park

834 Falls Avenue • Twin Falls

Daytime programs

MORNING

- 5:00 **3** DENNIS THE MENACE
1 DAYBREAK
2 MUPPETS
3 SUPERBOOK
4 A MILLIONAIRE'S SECRET TO WEALTH (MON-FRI)
5 SUCCESS STRATEGIES FOR WOMEN (TUE)
6 INSTANT CASH SYSTEMS (WED, THU)
7 MOVIE (TUE-FRI)
8 KEYS TO SUCCESS (MON)
9 NEWS (FRI)
10 WEEK AHEAD (MON)
11 IT FIGURES
 SHOW MOVIE (MON)
 SHOW D.C. BEACH PARTY: A MUSICAL CELEBRATION (TUE)
 SHOW THE WONDERFUL WORLD OF THE WOMBLES (WED)
 SHOW ROOM TO MOVE (THU)
 (TMC) MOVIE (TUE)
 CIN MOVIE (THU)
- 5:05 (SHOW) MOVIE (WED)
- 6:10 (SHOW) MOVIE (THU)
- 5:15 **12** DOWN TO EARTH
- 5:20 HBO MOVIE (WED)
- 6:30 **3** LASSIE
4 MORNING STRETCH
5 BUSINESS DAY
6 NEWS
7 M.A.S.K. **8**
9 **11** CBS NEWS
10 FLYING HOUSE
11 NEW GENERATION HAIR CARE (MON)
12 NBC NEWS
13 TODAY IN WASHINGTON (TUE-FRI)
14 NATION'S BUSINESS TODAY
15 RICHARD SIMMONS
 (TMC) MOVIE (WED, FRI)
 (TMC) FILM FEATURE (THU)
- 5:35 **3** FLINTSTONES
 CIN MOVIE (MON, FRI)
- 5:40 (SHOW) MOVIE (FRI)
- 5:55 HBO MOVIE (THU)
- 6:00 **2** **3** **4** **5** **11** CBS MORNING NEWS
6 BELLE AND SEBASTIAN
7 **8** **9** ABC NEWS **10**
11 DAYBREAK
12 SESAME STREET (R) **13**
14 **15** NEWS
16 **17** **18** 700 CLUB
19 BOZO
20 LEO THE LION
21 BREAK THRU TO WEIGHT LOSS (MON, FRI)
22 INSTANT CASH SYSTEMS (TUE)
23 A MILLIONAIRE'S SECRET TO WEALTH (WED, THU)
24 MOVIE (MON)
25 GOOD HOUSEKEEPING: A BETTER WAY
26 OLD MEN AT THE ZOO (FRI)
27 PRISONER OF ZENDA (MON)
28 AFRICA (TUE)
29 BARCHESTER CHRONICLES (WED)
30 GREAT DETECTIVE (THU)
 (SHOW) THE WONDERFUL WORLD OF THE WOMBLES (MON)
 (SHOW) ANIMALYMPICS (TUE)
 SHOW MOVIE (TUE, THU, FRI)
 (TMC) MOVIE (MON, THU)
- 6:05 **1** DREAM OF JEANNIE

- 6:10 CIN MOVIE (WED)
- 6:15 HBO REMEMBER WHEN: THE IMAGE MAKERS (TUE)
 CIN MAXTRAX (TUE)
- 6:25 HBO LINDA RONSTADT WITH THE NELSON RIDDLE ORCHESTRA (FRI)
- 6:30 **3** TODAY'S SPECIAL
4 **5** NBC NEWS
6 GENTLE BEN
7 JOURNALISTS ROUNDTABLE DISCUSSION (FRI)
8 VIEWER CALL-IN (MON-THU)
9 SPORTSCENTER
10 TURN ON TO FOOD
11 JANE EYRE (MON)
 SHOW MYSTERY ISLAND (WED)
- 6:35 **3** BEWITCHED
- 6:40 (SHOW) PAPER CHASE (WED)
- 6:50 (SHOW) HONEYMOONERS: THE LOST EPISODES (THU)
- 7:00 **3** PINWHEEL
4 **5** **6** GOOD MORNING AMERICA
7
8 DAYWATCH
9 **10** **11** TODAY
12 MASTER ROGERS (R)
13 **14** **15** FLINTSTONES
16 FLYING NUN
17 MICKEY MOUSE CLUB
18 CROOK AND CHASE
19 ROOM 222 (TUE-FRI)
20 V.J.: NINA BLACKWOOD
21 SPEEDWEEK (FRI)
22 OUTDOOR LIFE (MON)
23 INSIDE BASEBALL (TUE)
24 WORLD CUP SOCCER SPECIAL (WED)
25 HORSE RACING WEEKLY (THU)
26 ALL ABOUT US
27 SHORTSTORIES (FRI)
28 JAMES AT 16 (MON)
29 NANNY (TUE)
30 BUFFALO BILL (WED)
31 ARISTOCRATS (THU)
 HBO REMEMBER WHEN: THE IMAGE MAKERS (MON)
 SHOW ALMOS' A MAN (MON)
 (TMC) CIN MOVIE (TUE)
- 7:05 **3** DOWN TO EARTH
- 7:15 CIN MOVIE (MON)
- 7:30 **7** SESAME STREET (R) **8**
9 **10** **11** TRANSFORMERS
12 BEVERLY HILLBILLIES (MON-THU)
13 HAZEL
14 MOUSEERCISE
15 VIDEOCOUNTRY
16 GOOD MORNING WORLD (TUE-FRI)
17 CONGRESSIONAL HEARING (MON, TUE)
18 MORNING HEADLINES (WED, THU)
19 WORLD CLASS WOMEN (FRI)
20 PGA SENIORS GOLF (MON-WED)
21 WORLD CUP SOCCER (THU)
22 IT'S A GREAT LIFE
23 RISING DAMP (WED)
 HBO MOVIE (THU, FRI)
 HBO THE BERENSTAIN BEARS PLAY BALL (TUE)
 HBO BRAINGAMES (WED)
 (SHOW) MOVIE (FRI)
 (SHOW) JQSHUA'S, CONFUSION (MON)
 (SHOW) WHITE LIES (TUE)
 (SHOW) CAROLINE (THU)
 (TMC) MOVIE (WED, FRI)
 CIN ROCK AND ROLL: THE EARLY

- DAYS (FRI)
- 7:35 **3** I LOVE LUCY
- 8:00 **2** **3** **4** \$25,000 PYRAMID
5 **6** **7** SCOOBY DOO
8 **9** WALTONS
10 **11** DONAHUE
12 **13** 700 CLUB
14 GOOD MORNING MICKEY
15 YOU CAN BE A STAR
16 CARTOONS (FRI)
17 CALLIOPE (MON-THU)
18 U.S. HOUSE OF REPRESENTATIVES FLOOR DEBATE (WED-FRI)
19 AUTO RACING (FRI)
20 SHOW MOVIE
21 TWENTIETH CENTURY (FRI)
22 DUTCH NATIONAL BALLET (MON)
23 DIANA (TUE)
24 HORIZONS (WED)
25 JAZZMAKERS (THU)
 HBO BLUE LINE (MON)
 HBO I WANT TO GO HOME (TUE)
 HBO SURVIVAL (WED)
 (SHOW) MOVIE (MON)
 (SHOW) D.C. BEACH PARTY: A MUSICAL CELEBRATION (TUE)
 (SHOW) THE WONDERFUL WORLD OF THE WOMBLES (WED)
 (SHOW) ROOM TO MOVE (THU)
 (TMC) MOVIE (MON, THU)
 CIN MOVIE (WED, THU)
- 8:05 **3** MOVIE
- 8:30 **2** **3** **4** **5** **6** **7** **8** **9** **10** **11** **12** **13** **14** **15** **16** **17** **18** **19** **20** **21** **22** **23** **24** **25** **26** **27** **28** **29** **30** **31** **32** **33** **34** **35** **36** **37** **38** **39** **40** **41** **42** **43** **44** **45** **46** **47** **48** **49** **50** **51** **52** **53** **54** **55** **56** **57** **58** **59** **60** **61** **62** **63** **64** **65** **66** **67** **68** **69** **70** **71** **72** **73** **74** **75** **76** **77** **78** **79** **80** **81** **82** **83** **84** **85** **86** **87** **88** **89** **90** **91** **92** **93** **94** **95** **96** **97** **98** **99** **100**
- 1** **2** **3** **4** **5** **6** **7** **8** **9** **10** **11** **12** **13** **14** **15** **16** **17** **18** **19** **20** **21** **22** **23** **24** **25** **26** **27** **28** **29** **30** **31** **32** **33** **34** **35** **36** **37** **38** **39** **40** **41** **42** **43** **44** **45** **46** **47** **48** **49** **50** **51** **52** **53** **54** **55** **56** **57** **58** **59** **60** **61** **62** **63** **64** **65** **66** **67** **68** **69** **70** **71** **72** **73** **74** **75** **76** **77** **78** **79** **80** **81** **82** **83** **84** **85** **86** **87** **88** **89** **90** **91** **92** **93** **94** **95** **96** **97** **98** **99** **100**

SWIMWEAR
20% OFF
 thru June
KIDS KLOTHES
 Blue Lakes Mall • By The Fountain

Daytime

- HBO MOVIE
(SHOW) MOVIE (TUE, THU, FRI)
(TMC) MOVIE (TUE, WED)
CIN MOVIE (MON)
- 9:30 (1) (2) MOTORWEEK (FRI)
(1) (2) TAKEOVER (MON)
(1) (2) DINING IN FRANCE (TUE)
(1) (2) BODYWATCH (WED)
(1) (2) COOKING CHEAP (THU)
(1) (2) DIVORCE COURT
(1) SALE OF THE CENTURY
(1) SUCCESS 'N' LIFE (TUE-FRI)
(1) AMERICAN BABY (MON)
(1) DUMBO'S CIRCUS
(1) ALICE
(1) NEW LOVE AMERICAN STYLE
(1) SPORTSLOOK
(1) BORGAS (FRI)
(1) BACH GOES EAST (THU)
(SHOW) MYSTERY ISLAND (WED)
SHOW MOVIE (WED)
(TMC) MOVIE (THU, FRI)
- 10:00 (2) (1) YOUNG AND THE REST-
LESS
(1) PINWHEEL
(1) (2) SESAME STREET (R) □
(1) NEW LOVE AMERICAN STYLE
(1) TAKE TWO
(1) (2) RYAN'S HOPE
(1) (2) WHEEL OF FORTUNE
(1) 3-2-1 CONTACT □
(1) (12) JIMMY SWAGGART
(1) LITTLE HOUSE ON THE PRAIRIE
(1) (1) \$25,000 PYRAMID
(1) BILL COSBY
(1) YOU AND ME, KID
(1) CALLHOPE (FRI)
(1) SALE OF THE CENTURY
(1) TALKABOUT
(1) U.S. HOUSE OF REPRESENTA-
TIVES FLOOR DEBATE (MON, TUE)
(1) AEROBICS
(1) MOTHER'S DAY
(1) CLAUDE BOLLING CONCERTO
(MON)
(1) ONE BY ONE (TUE)
(1) JAZZMAKERS (WED)
(SHOW) ALMOS' A MAN (MON)
SHOW MOVIE (MON, TUE, THU, FRI)
(TMC) MOVIE (MON)
CIN MOVIE (WED)
- 10:06 (1) PERRY MASON
10:30 (2) RYAN'S HOPE
(1) (2) LOVING
(1) (2) SCRABBLE
(1) VOYAGE OF THE MIMI (FRI)
(1) READING RAINBOW (MON, THU)
(1) (12) CAROL BURNETT AND
FRIENDS
(1) (2) (11) YOUNG AND THE REST-
LESS
(1) DORIS DAY
(1) MOVIE
(1) NEW COUNTRY
(1) WHEEL OF FORTUNE
(1) FASHION AMERICA
(1) WHAT EVERY BABY KNOWS
(1) WYNTON MARSALIS - CATCHING
A SNAKE (WED)
(1) RHYTHM ON TWO: GEORGE
SHEARING (THU)
HBO (TMC) MOVIE (TUE)
CIN MOVIE (THU, FRI)
- 10:50 (2) MAJOR MINOR FILM FESTI-
VAL (FRI)
- 11:00 (1) BREAK THE BANK
(1) PRESS YOUR LUCK
(1) (2) (3) ALL MY CHILDREN
(1) SALE OF THE CENTURY
(1) MISTER ROGERS (R)
(1) DONAHUE
(1) (2) FANTASY ISLAND
(1) NEWS (FRI)
(1) MIDDAY (MON-THU)

- 11:00 (1) PARNETT'S DAUGHTER
(1) (SHOW) MOVIE
(1) WAKE ME CAUGH
(1) HOUR MAGAZINE
(1) VJ: ALAN HUNTER
(1) U.S. HOUSE OF REPRESENTA-
TIVES FLOOR DEBATE (WED-FRI)
(1) HISTORY OF U.S. OPEN GOLF
(FRI)
(1) NCAA COLLEGE WORLD SERIES
(MON)
(1) AUTO RACING (TUE)
(1) BOWLING (WED)
(1) TOP RANK BOXING (THU)
(1) GOOD HOUSEKEEPING: A BET-
TER WAY
(1) MAELSTROM (FRI)
(1) GREAT DETECTIVE (MON)
(1) WILLIAM STYRON (TUE)
(1) JAZZ AT THE SMITHSONIAN
(THU)
HBO MOVIE (MON, WED-FRI)
(TMC) MOVIE (WED)
CIN MOVIE (MON, TUE)
- 11:05 (1) MOVIE
11:30 (1) (2) (11) AS THE WORLD
TURNS
(1) TIC TAC DOUGH
(1) SESAME STREET (R) □
(1) PATTY DUKE
(1) GONG SHOW
(1) GOLF (FRI)
(1) FASHION AMERICA
(1) BACH GOES EAST (WED)
SHOW MOVIE (WED)
(TMC) MOVIE (MON, THU)
- 11:40 (2) A DAY IN NATURE'S COMMU-
NITY (FRI)

AFTERNOON

- 12:00 (1) TODAY'S SPECIAL
(1) (2) (3) ONE LIFE TO LIVE
(1) NEWSDAY
(1) (1) NEWS
(1) (12) LEAVE IT TO BEAVER
(1) DICK VAN DYKE
(1) FATHER KNOWS BEST
(1) DANGER BAY (FRI)
(1) EDISON TWINS (MON)
(1) ANIMALS IN ACTION (TUE)
(1) STILL THE BEAVER (WED)
(1) THAT GIRL
(1) WORLD CUP SOCCER (WED)
(1) REGIS PHILBIN'S LIFESTYLES
(1) NANNY (FRI)
(1) EVENING AT THE IMPROV (MON)
(1) HORIZONS (TUE)
(1) ITALIANS (THU)
SHOW MOVIE (TUE, THU, FRI)
(TMC) MOVIE (FRI)
- 12:05 SHOW MOVIE (MON)
12:30 (1) (2) (11) CAPITOL
(1) BELLE AND SEBASTIAN
(1) (2) NEWS
(1) KNITTING WORKSHOP (FRI)
(1) MAGIC OF FLORAL PAINTING
(MON)
(1) GREAT CHEFS OF SAN FRANCIS-
CO (TUE)
(1) YAN CAN COOK (WED)
(1) PLAY MORE BRIDGE (THU)
(1) SUPER PASSWORD
(1) (12) GOMER PYLE
(1) CAROL BURNETT AND FRIENDS
(1) COURTSHIP OF EDDIE'S FATHER
(1) WALT DISNEY PRESENTS
(1) VIDEOCOUNTRY
(1) MR. AND MRS. (FRI)
(1) MR. MERLIN (MON)
(1) SECOND HUNDRED YEARS (TUE)
(1) TEMPERATURES RISING (WED)
(1) GIRL WITH SOMETHING EXTRA
(THU)
- (1) DIVING (TUE)
(1) RHYTHM ON TWO: GEORGE
SHEARING (WED)
(1) BORGAS (THU)
HBO NOT NECESSARILY THE NEWS
(TUE)
(SHOW) MOVIE (WED)
CIN MOVIE (THU, FRI)
- 12:35 (1) WOMANWATCH (FRI)
1:00 (1) (2) (11) GUIDING LIGHT
(1) ADVENTURES OF BLACK BEAU-
TY
(1) (2) (3) GENERAL HOSPITAL
(1) INTERNATIONAL HOUR
(1) (2) (3) SANTA BARBARA
(1) HEART OF THE DRAGON (FRI)
(1) RUSH (MON)
(1) IN SEARCH OF THE TROJAN
WAR (TUE)
(1) NOVA (WED)
(1) SMITHSONIAN WORLD (THU)
(1) (12) BEVERLY HILLBILLIES
(1) ANDY GRIFFITH
(1) 700 CLUB
(1) YOU CAN BE A STAR
(1) HBO MOVIE
(1) DIMENSIONS IN SCIENCE (FRI)
(1) TEN GREEN BOTTLES (MON)
(1) ARCHIVES OF TIME (TUE)
(1) TOWARDS 2000 (WED)
(1) HUMAN FOIBLE (THU)
(1) U.S. HOUSE OF REPRESENTA-
TIVES FLOOR DEBATE (MON-WED)
(1) NURSE
(1) ONE BY ONE (FRI)
(1) BUFFALO BILL (MON)
(1) MAN WHO HD ANNE FRANK
(TUE)
(1) JAZZ AT THE SMITHSONIAN
(WED)
(SHOW) MOVIE (MON, TUE, THU,
FRI)
(TMC) MOVIE (MON-THU)
CIN MOVIE (MON, WED)
- 1:05 (1) SUPERFRIENDS
1:15 CIN MOVIE (TUE)
1:30 (1) DANGER MOUSE
(1) (12) PETTICOAT JUNCTION
(1) BUGS BUNNY
(1) ADVENTURES OF OZZIE & HAR-
RIET
(1) FANDANGO
(1) PLANET OF MAN (FRI)
(1) FOREST FROM THE DAWN OF
TIME (MON)
(1) ISLAND OF THE SPIRITS (TUE)
(1) O.E.D. (WED)
(1) OBSESSION (THU)
(1) INSIDE THE PGA TOUR (FRI)
(1) SURFING (THU)
(1) RISING DAMP (MON)
1:35 (1) BUGS BUNNY AND FRIENDS
1:45 (2) MAJOR MINOR FILM FESTI-
VAL (THU)
- 2:00 (1) (2) (11) PRESS YOUR LUCK
(1) YOU CAN'T DO THAT ON TELEVI-
SION
(1) HOUR MAGAZINE
(1) DIVORCE COURT
(1) NEWSDAY
(1) ONE DAY AT A TIME
(1) (2) (3) ANOTHER WORLD
(1) MODERN MATURITY (FRI)
(1) MASTERPIECE THEATRE (MON)
(1) OK HART (TUE)
(1) FRONTLINE (WED)
(1) ADAM SMITH IN THE NEW CHINA:
FROM MARX TO MASTERCARD?
(THU)
(1) FLINTSTONES (MON, TUE, FRI)

Daytime

- (9) (12) GIDGET
 (9) HEATHCLIFF
 (1) FACE THE MUSIC
 (1) (10) MOVIE
 (1) NASHVILLE NOW
 (1) V.J.: MARTHA QUINN
 (6) DALLAS
 (2) MERV GRIFFIN
 (2) JOHN LAW'S WORLD (FRI)
 (2) DISAPPEARING WORLD (MON)
 (2) THE WHALE SAVERS (TUE)
 (2) VISTA (WED)
 (2) ASIAN INSIGHTS (THU)
 (2) U.S. HOUSE OF REPRESENTATIVES FLOOR DEBATE (THU, FRI)
 (1) PGA SENIORS GOLF (FRI)
 (1) ROLLER DERBY (MON)
 (1) AUSTRALIAN RULES FOOTBALL (TUE)
 (1) RODEO (WED)
 (1) HORSESHOW (THU)
 (6) DIANA (FRI)
 (6) JAMES AT 16 (MON)
 (6) NANNY (TUE)
 (6) BUFFALO BILL (WED)
 (6) TWENTIETH CENTURY (THU)
 SHOW WHITE LIES (TUE, FRI)
 SHOW JOSHUA'S CONFUSION (MON)
 SHOW MYSTERY ISLAND (WED)
 SHOW SOMETIMES I WONDER (THU)
 (TMC) MOVIE (FRI)
 2:05 (3) FLINTSTONES (WED, THU)
 2:30 (2) HEADLINE CHASERS
 (1) LASSIE
 (4) NEWLYWED GAME
 (1) NEW LOVE AMERICAN STYLE
 (7) CATS AND DOGS (FRI)
 (1) ADDAMS FAMILY (MON, TUE, FRI)
 (1) (12) BEWITCHED
 (7) TRANSFORMERS
 (2) (11) CARD SHARKS
 (1) \$1,000,000 NAME THAT TUNE
 (6) RISING DAMP (WED)
 (6) DON'T WAIT UP (THU)
 HBO (SHOW) MOVIE (WED)
 SHOW MOVIE (TUE, FRI)
 SHOW ANIMALYMPICS (MON)
 CIN MAXTRAX (MON)
 2:35 (1) ADDAMS FAMILY (WED, THU)
 3:00 (2) (7) LOVE BOAT
 (1) DENNIS THE MENACE
 (3) TOM AND JERRY
 (4) EIGHT IS ENOUGH
 (1) NEWSWATCH
 (1) PERFECT MATCH
 (2) (8) (1) DAYS OF OUR LIVES
 (7) MISTER ROGERS (R)
 (1) LEAVE IT TO BEAVER (TUE, FRI)
 (1) SAFE AT HOME (MON)
 (7) (12) SHE-RA: PRINCESS OF POWER
 (7) G.I. JOE
 (2) (11) I DREAM OF JEANIE
 (1) TIC TAC DOUGH
 (1) ALIVE & WELL
 (1) NEW VIDEO HOUR (MON)
 (1) HEAVY METAL MANIA (THU)
 (6) DIVORCE COURT
 (2) ISLAND WILDLIFE (FRI)
 (2) JOURNEY INTO INDIA (MON)
 (2) ONCE IN A LIFETIME (TUE)
 (2) ANIMALS OF THE GREAT NORTHWEST (WED)
 (2) IN THE WILD WITH HARRY BUTLER (THU)
 (1) FLY FISHING WITH JOE HUMPHREYS (MON)
 (1) FISHIN' HOLE (TUE)

- (1) SPORTSLOOK (WED)
 (6) CIN MOVIE
 HBO MOVIE (MON, THU, FRI)
 HBO BOB DYLAN IN CONCERT (TUE)
 (SHOW) MOVIE (TUE, THU, FRI)
 SHOW ROOM TO MOVE (THU)
 (TMC) FILM FEATURE (MON)
 (TMC) MOVIE (TUE-THU)
 3:05 (4) LEAVE IT TO BEAVER (WED, THU)
 (SHOW) MOVIE (MON)
 3:30 (3) TURKEY TELEVISION
 (1) BRADY BUNCH
 (1) (10) MAGIC OF OIL PAINTING
 (1) LOVE CONNECTION
 (7) 3-2-1 CONTACT (FRI)
 (7) READING RAINBOW (MON-THU)
 (1) ROCKY ROAD (MON, TUE, FRI)
 (1) (12) HE-MAN AND MASTERS OF THE UNIVERSE
 (7) LAVERNE & SHIRLEY
 (2) (11) BEWITCHED
 (1) GOI
 (2) WIND IN THE WILLOWS (THU)
 (1) NEW COUNTRY
 (6) BREAK THE BANK (TUE, THU, FRI)
 (1) CAN YOU BE THINNER? (MON, WED)
 (2) HANDS (MON)
 (2) WILDLIFE CINEMA (WED)
 (2) STATIONARY ARK (THU)
 (1) WORLD OF SPORTS (MON)
 (1) HORSE RACING WEEKLY (WED)
 (1) TENNIS MAGAZINE REPORTS (THU)
 SHOW THE WONDERFUL WORLD OF THE WOMBLES (WED)
 (TMC) MOVIE (MON, FRI)
 3:35 (1) ROCKY ROAD (WED, THU)
 (1) DISNEY CHANNEL PREVIEW (MON)
 (6) RACCOONS (TUE)
 3:50 (2) SUPERED (THU)
 4:00 (2) HOUR MAGAZINE
 MR. MR. WAGARD'S WORLD
 (3) LITTLE HOUSE ON THE PRAIRIE
 (4) (7) (10) SESAME STREET (R) (C)
 (4) DIFF'RENT STROKES
 (1) EIGHT IS ENOUGH

- (7) BUCK ROGERS
 (1) BASEBALL (FRI)
 (1) DOWN TO EARTH (MON)
 (1) GOMER PYLE (TUE)
 (8) (2) (11) NEWLYWED GAME
 (1) (12) THUNDERCATS (C)
 (7) ONE DAY AT A TIME
 (1) GREEN ACRES
 (1) DUMBO'S CIRCUS
 (1) CROOK AND CHASE
 (1) LIAR'S CLUB
 (1) PEOPLE'S COURT
 (1) V.J.: MARTHA QUINN
 (6) ROCKFORD FILES
 (2) \$1,000,000 CHANCE OF A LIFE TIME
 (2) PORTRAITS OF POWER (FRI)
 (2) DIMENSIONS IN SCIENCE (MON)
 (2) HORIZON (TUE)
 (2) MRS. LIVINGSTON, I PRESUME (WED)
 (2) AUSTRALIAN ARK (THU)
 (2) VIEWER CALL-IN
 (1) SPORTSLOOK (MON, TUE, THU, FRI)
 (1) WORLD CUP SOCCER (WED)
 (6) RICHARD SIMMONS
 HBO MOVIE (TUE)
 SHOW MOVIE (MON, TUE, THU, FRI)
 4:05 (1) GOMER PYLE (WED, THU)
 4:30 (2) NICK ROCK'S VIDEO TO GO
 (4) BENSON
 (1) SHOWBIZ TODAY
 (1) GUNSMOKE (MON, TUE)
 (8) (2) (11) PEOPLE'S COURT
 (3) (12) G.I. JOE
 (3) WELCOME BACK, KOTTER
 (1) RIFLEMEN
 (1) WELCOME TO POOH CORNER
 (1) VIDEOCOUNTRY
 (1) JOKER'S WILD
 (1) NEWS
 (1) PRICE IS RIGHT
 (2) BEST KEPT SECRETS (FRI)
 (2) PLANET OF MAN (MON)
 (1) FISHING: MARK SOSIN'S BAIT WATER JOURNAL (FRI)
 (1) FISHING: JOHN FOX'S OUTDOOR ADVENTURES (MON)
 (1) WORLD CLASS WOMEN (TUE)

GREAT MAGNAVOX SAVINGS!

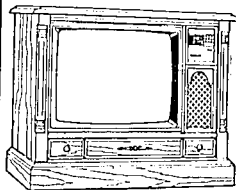

RF4940PE

MAGNAVOX RF4940PE
 25" Diagonal Console
 Videomatic Color TV •
 Contrast • 52 picture
 tube C.F.F. • Digital control
 scan tuning • 17-function IR
 remote control • 152 total
 channel capability • Green
 LED channel • MX/400
 chassis • Videomatic • Elec-
 tronic volume up/down •
 4"x6" speaker • Stereo/SAP
 Jack.

Reg. \$699.95
\$599⁹⁵ W/T

KEN'S FURNITURE & APPLIANCES

MAGNAVOX HOME ENTERTAINMENT CENTER

493 Main Avenue East, Twin Falls • 733-9334
 Open Monday-Friday 9:00-6:00; Saturday 9:00-5:00

- ① INSIDE THE PGA TOUR (THU)
- ② IT FIGURES
- ③ HERITAGE OF THE CHINESE OP-ERA (FRI)
- (TMC) FILM FEATURE (WED)
- 4:35 ④ GUNSMOKE (WED, THU)
- 5:00 ⑤ JEOPARDY
- ⑥ YOU CAN'T DO THAT ON TELEVISION
- ⑦ MISTER ROGERS (R)
- ⑧ ABC NEWS □
- ⑨ MONEYLINE
- ⑩ PEOPLE'S COURT
- ⑪ NEWS
- ⑫ NATURE OF THINGS (FRI)
- ⑬ DINING IN FRANCE (MON)
- ⑭ HEART OF THE DRAGON (TUE)
- ⑮ IN SEARCH OF THE TROJAN WAR (WED)
- ⑯ NATURE (THU)
- ⑰ THREE'S COMPANY
- ⑱ (12) LITTLE HOUSE ON THE PRAIRIE
- ⑲ PRIVATE BENJAMIN
- ⑳ (11) ENTERTAINMENT TONIGHT
- ㉑ MAN FROM U.N.C.L.E.
- ㉒ MICKEY MOUSE CLUB
- ㉓ YOU CAN BE A STAR
- ㉔ BULLSEYE
- ㉕ NBC NEWS
- ㉖ M*A*S*H
- ㉗ DIAMONDS IN THE SKY (FRI)
- ㉘ TOWARDS 2000 (MON)
- ㉙ TEN GREEN BOTTLES (TUE)
- ㉚ ONE FALSE MOVE (WED)
- ㉛ PERSPECTIVE (THU)
- ㉜ NATIONAL PRESS CLUB

- ① SPORTSCENTER (MON, TUE, THU, FRI)
- ② FAMILY
- ③ OLD MEN AT THE ZOO (FRI)
- ④ PRISONER OF ZENDA (MON)
- ⑤ AFRICA (TUE)
- ⑥ BARCHESTER CHRONICLES (WED)
- ⑦ SHORTSTORIES (THU)
- HBO VIDEO JUKEBOX (FRI)
- HBO BLUE LINE (MON, THU)
- HBO SURVIVAL (WED)
- (SHOW) WHITE LIES (TUE, FRI)
- (SHOW) JOSHUA'S CONFUSION (MON)
- (SHOW) MYSTERY ISLAND (WED)
- (SHOW) SOMETIMES I WONDER (THU)
- SHOW HONEYMOONERS: THE LOST EPISODES (WED)
- (TMC) MOVIE (TUE-THU)
- CIN MOVIE (FRI)
- CIN SCTV (MON-THU)
- 5:30 ⑦ ⑧ ⑨ ⑩ (11) CBS NEWS
- ⑪ DANGER MOUSE
- ⑫ 3-2-1 CONTACT □ (FRI)
- ⑬ READING RAINBOW (MON-THU)
- ⑭ NEWS
- ⑮ CROSSFIRE
- ⑯ ABC NEWS □
- ⑰ NBC NEWS
- ⑱ INNOVATION (MON)
- ⑲ SANFORD AND SON (MON, TUE)
- ㉑ BASEBALL (MON-WED, FRI)
- ㉒ ALICE (THU)
- ㉓ THE BAMBOO BRUSH (FRI)

Daytime

- ① CRAZY CARLITA (MON)
- ② ZERTIGO DIAMOND CAPER (TUE)
- ③ IDA MAKES A MOVIE (WED)
- ④ MOVIE (THU)
- ⑤ FANDANGO
- ⑥ JACKPOT
- ⑦ THREE'S COMPANY
- ⑧ O.E.D. (MON)
- ⑨ FOREST FROM THE DAWN OF TIME (TUE)
- ⑩ LIVING TOMORROW (THU)
- ⑪ NFL YEARBOOK: 1985 CHICAGO BEARS (FRI)
- ⑫ INSIDE BASEBALL (MON)
- ⑬ AUTO RACING'S SPECIAL: MICHELLE MOUTON EXPLAINS RALLY RACING (TUE)
- ⑭ SPEEDWEEK (THU)
- ⑮ JANE EYRE (MON)
- HBO MOVIE (FRI)
- (SHOW) MOVIE (TUE, FRI)
- (SHOW) ANIMALYMPICS (MON)
- (TMC) MOVIE (MON, FRI)
- CIN MOVIE (MON-THU)
- 6:35 ⑯ SANFORD AND SON (WED, THU)

TIMES-NEWS
CLASSIFIED ADVERTISING
PHONE 733-0626

A World of Difference in Fine Eyewear

SPECIAL SAVINGS

SAVE 50% OFF

The cost of any frame in stock when you purchase a complete pair of frames and lenses before June 30, 1986.

ASK ABOUT A PAIR OF CONTACT LENSES JUST RIGHT FOR YOUR VISION CORRECTION.

This sale may not be combined with any other offer.

Vision Care Center at Sears
Twin Falls
734-2233/733-0821

OPTOMETRIST AT **Sears**



There's more for your life at
SEARS



Friday evening programs

6:00 **1** **2** **3** **4** **5** **6** **7** **8** **9** **10** **11** **12** **13** **14** **15** **16** **17** **18** **19** **20** **21** **22** **23** **24** **25** **26** **27** **28** **29** **30** **31**

NEWS

- 1** MY THREE SONS
- 2** BUSINESS REPORT
- 3** WHEEL OF FORTUNE
- 4** PRIMENEWS

5 WILD, WILD WORLD OF ANIMALS Indian wildlife is virtually unknown to us but it includes some of the most beautiful and spectacular animals on Earth.

6 (12) BASEBALL Seattle Mariners at Chicago White Sox (Live)

7 CAMPBELLS After the Campbells arrive at their new home in Canada, a neighbor attempts to drive them off their land.

8 NEW! ANIMAL WORLD

9 NASHVILLE NOW

10 CHAIN REACTION

11 ENTERTAINMENT TONIGHT Interview with country singer Tanya Tucker.

12 ARCHIVES OF TIME

13 CONGRESSIONAL HEARING

14 AUTO RACING Mint 400 Off-Road Race from Las Vegas. (Taped)

15 FROM HERE TO ETERNITY

16 MOVIE ★★ "The Leather Boys" (1966, Drama) Rita Tushingham, Dudley Sutton.

17 SHOW MOVIE ★★ "The Border" (1981, Drama) Jack Nicholson, Valeria Perrine.

6:30 **1** **2** **3** **4** **5** **6** **7** **8** **9** **10** **11** **12** **13** **14** **15** **16** **17** **18** **19** **20** **21** **22** **23** **24** **25** **26** **27** **28** **29** **30** **31**

WHEEL OF FORTUNE

1 MISTER ED "Ed, The Sentry"

2 WILD AMERICA A look at the wolverine in its remote and rugged habitat.

3 JEOPARDY

4 LET'S GO TO THE RACES

5 ALICE Alice discovers that one of the diner's regulars may be a gangster.

6 BUSINESS REPORT

7 BETWEEN GAMES

8 M*A*S*H B.J. writes home to his wife reporting Klinger's escape attempt and one of Frank's goof-ups.

9 DORIS DAY'S BEST FRIENDS Guest: Cleveland Amory.

10 DONALD DUCK PRESENTS

11 ALL-STAR BLITZ

12 PH MAGAZINE Actress Stephanie

Zimbalist ("Remington Steele"); the F-20 Tigerhawk, a new fighter jet.

13 \$100,000 PYRAMID

14 PRIME TIME ACCESS

15 VALLEY OF ICE

7:00 **1** **2** **3** **4** **5** **6** **7** **8** **9** **10** **11** **12** **13** **14** **15** **16** **17** **18** **19** **20** **21** **22** **23** **24** **25** **26** **27** **28** **29** **30** **31**

TWILIGHT ZONE

Three stories: a bogeyman lurks under a youngster's bed; a boy learns devilish tricks from a rented doocassette; strange things happen

1 ALL-STAR BLITZ

2 PH MAGAZINE Actress Stephanie Zimbalist ("Remington Steele"); the F-20 Tigerhawk, a new fighter jet.

3 \$100,000 PYRAMID

4 PRIME TIME ACCESS

5 VALLEY OF ICE

7:00 **1** **2** **3** **4** **5** **6** **7** **8** **9** **10** **11** **12** **13** **14** **15** **16** **17** **18** **19** **20** **21** **22** **23** **24** **25** **26** **27** **28** **29** **30** **31**

TWILIGHT ZONE

Three stories: a bogeyman lurks under a youngster's bed; a boy learns devilish tricks from a rented doocassette; strange things happen

Daytime movies

5:00 **1** ★ "Thieves" (1977, Comedy)

Marlo Thomas, Charles Grodin.

5:30 (TMC) ★★ "Royal Wedding" (1951, Musical) Fred Astaire, Jane Powell.

5:35 CIN ★★ "The Westerner" (1940, Western) Gary Cooper, Walter Brennan.

5:40 (SHOW) ★★ "Kelly" (1981, Drama) Robert Logan, Twyla-Dawn Vokins.

6:00 SHOW ★★ "Comfort And Joy" (1984, Comedy) Bill Paterson, Eleanor David.

7:30 HBO ★★ "White Water Sam" (1977, Adventure) Keith Larson.

(SHOW) ★★ "Dusty" (1981, Drama) Bill Kerr, Noel Travathan.

(TMC) ★★ "Vision Quest" (1985, Drama) Matthew Modine, Linda Fiorentino.

8:00 **1** ★★ "Once In Paris" (1978, Drama) Wayne Rogers, Gayle Hunnicutt.

SHOW ★★ "Rido, Vaquerol" (1953, Western) Robert Taylor, Ava Gardner.

8:05 **2** ★★ "Mara Of The Wilderness" (1965, Adventure) Adam West, Linda Saunders.

8:30 CIN ★★ "Dreamscape" (1984, Science Fiction) Dennis Quaid, Max Von Sydow.

9:00 HBO ★★ "The NeverEnding Story" (1984, Fantasy) Noah Hathaway, Barret Oliver.

(SHOW) ★★ "Comfort And Joy" (1984, Comedy) Bill Paterson, Eleanor David.

9:30 (TMC) ★★ "F.I.S.T." (1978, Drama) Sylvester Stallone, Peter Boyle.

10:00 SHOW ★★ "Gremlins" (1984, Fantasy) Zach Galligan, Hoyt Axton.

10:30 **3** ★★ "Jungle Cat" (1960, Documentary) Narrated by Winston Hibler.

CIN ★★ "Pygmalion" (1938, Comedy) Leslie Howard, Wendy Hiller.

11:00 **4** ★★ "The Roaming Cowboy"

(1937, Western) Fred Scott, Al St. John.

HBO ★★ "Conan The Destroyer" (1984, Adventure) Arnold Schwarzenegger, Grace Jones.

(SHOW) ★★ "Rido, Vaquerol" (1953, Western) Robert Taylor, Ava Gardner.

11:05 **5** ★★ "Larry" (1974, Drama) Frederic Forrest, Tyna Daly.

12:00 SHOW ★★ "Comfort And Joy" (1984, Comedy) Bill Paterson, Eleanor David.

(TMC) ★★ "Royal Wedding" (1951, Musical) Fred Astaire, Jane Powell.

12:30 CIN ★★ "Cimarron" (1961, Western) Glenn Ford, Maria Schell.

1:00 **6** ★★ "Sister, Sister" (1982, Drama) Diahann Carroll, Rosalind Cash.

HBO ★★ "Chattanooga Choo Choo" (1984, Comedy) George Kennedy, Joo Namath.

(SHOW) ★★ "Gremlins" (1984, Fantasy) Zach Galligan, Hoyt Axton.

2:00 **7** ★★ "Knight Without Armour" (1937, Adventure) Robert Donat, Marlene Dietrich.

8 ★★ "Honeymoon" (1968, Romance) Anthony Steel, Ludmila Tcherina.

(TMC) ★★ "Escape From El Diablo" (1983, Adventure) Jimmy McNichol, Timothy Van Patten.

2:30 SHOW ★★ "Dusty" (1981, Drama) Bill Kerr, Noel Travathan.

3:00 **9** ★★ "The Emperor Jones" (1933, Drama) Paul Robeson, Dudley Diggs.

HBO ★★ "9 To 5" (1980, Comedy) Jane Fonda, Dolly Parton.

(SHOW) ★★ "Comfort And Joy" (1984, Comedy) Bill Paterson, Eleanor David.

CIN ★★ "The Little Foxes" (1941, Drama) Bette Davis, Herbert Marshall.

3:30 (TMC) ★★ "Vision Quest" (1985, Drama) Matthew Modine, Linda Fiorentino.

Daytime sports

8:30 **1** SPORTSCENTER

7:00 **2** SPEEDWEEK A weekly report on auto racing.

7:30 **3** WORLD CLASS WOMEN

8:00 **4** AUTO RACING CART Portland -200, from Portland, Ore. (R)

9:30 **5** SPORTSLOOK

11:00 **6** HISTORY OF U.S. OPEN GOLF

11:30 **7** GOLF Crosby Clambake, from Winston-Salem, N.C. (R)

1:30 **8** INSIDE THE CHICAGO TOUR

2:00 **9** PGA SENIORS GOLF Tourna-

ment Players Championship, first round, live from Cleveland.

4:00 **1** BASEBALL Atlanta Braves at Cincinnati Reds (Live)

2 SPORTSLOOK

4:30 **3** FISHING: MARK BOSCH'S SALT WATER JOURNAL

6:00 **4** SPORTSCENTER

6:30 **5** BASEBALL Chicago Cubs at New York Mets (Live)

6 NFL YEARBOOK: 1985 CHICAGO BEARS

BEYOND REPAIR?

Let us make that decision. We do all kinds of lamp and lighting repairs.



- ★ Replacement Glass
- ★ Lamp Shades
- ★ Lamp Repairs

8:30-5:30 Weekdays • 10-3 Saturdays

the lighting center
1920 Kimberly Road
733-1382

BOISE EVENING TELEVISION GUIDE

| FRIDAY EVENING | | 7:00 | 7:30 | 8:00 | 8:30 | 9:00 | 9:30 | 10:00 | 10:30 | 11:00 | 11:30 | 12:00 | 12:30 |
|----------------|----------------------------------|---------------------------------|-------------------|---------------------|------------------------------|---------------------|-------------------|-------------|---------------------------------------|----------|---------------------|-------|-------|
| 2 | Twilight Zone | Movie: "Victory" | | | News | | | G. Miller | Movie: "The Heart Is A Lonely Hunter" | | | | |
| 3 | MacNeil / Lehrer | W. Waak | Wall St. | Great Performances | | | Bodywalc. | Firing Line | | | | | |
| 4 | Webster | Belvedere | Sunshine | Comedy | Love Boat | | | News | Entertain. | Highline | Movie | | |
| 5 | Knight Rider | Miami Vice | | | Stingray | | | News | Tonight | | Friday Night Videos | | |
| 9 | Baseball Cont'd | Movie: "Mother, Jugs And Speed" | | | | | | Quincy | | Movie | | | |
| 12 | Twilight Zone | Movie: "Victory" | | | News | | | M*A*S*H | Movie: "The Heart Is A Lonely Hunter" | | | | |
| SHOW | Movie: "Skirts Ahoy" | | | Movie: "The Border" | | | Movie: "Gremlins" | | | | | | |
| SHOW | Movie Cont'd | | Movie: "Gremlins" | | | Movie: "Caddyshack" | | | Movie | | | | |
| HBO | Movie: "Mom, The Wolfman And Me" | | | | Movie: "Conan The Destroyer" | | | | Movie: "Blood Simple" | | | | |

Friday

- after a man murders his lover's husband. (R)
- 3 ISPY
- 3 10 MACNEIL / LEHRER NEWSHOUR
- 4 4 4 WEBSTER Webster plays Cupid for George's father and Katherine's aunt. (R) □
- 5 LARRY KING LIVE
- 6 6 6 KNIGHT RIDER Michael and KITT engaged in a beach battle with The Hovercraft, a roving aquatic arsenal. In stereo. (R)
- 7 WALL STREET WEEK "Stockman on Reagan" Guest: former Budget Director David Stockman.
- 8 BASEBALL Atlanta Braves at Cincinnati Reds (Live)
- 9 700 CLUB
- 10 MOVIE *** "The Road To Rio" (1947, Comedy) Bing Crosby, Bob Hope.
- 11 CARTOONS
- 12 VJ: MARK GOODMAN
- 13 BALLOONING IN EUROPE
- 14 TOP RANK BOXING Jimmy Navarro vs. Darryl Thigpen in a bantamweight bout scheduled for 12 rounds, live from Atlantic City, N.J.
- 15 REGIS PHILBIN'S LIFESTYLES
- HBO MOVIE ** "Mom, The Wolfman And Me" (1980, Drama) Patty Duke Aulin, David Birney.
- (SHOW) MOVIE *** "Skirts Ahoy" (1952, Comedy) Esther Williams, Vivian Blaine.
- (TMC) MOVIE * "Night School" (1981, Mystery) Leonard Mann, Rachel Ward.
- CN MOVIE *** "Dreamscape"

- (1984, Science Fiction) Dennis Quaid, Max Von Sydow.
- 7:30 (4) (4) (4) MR. BELVEDERE Marcha decides to drop out of law school. (R) □
- (7) WASHINGTON WEEK IN REVIEW □
- (13) NEW COUNTRY
- (16) VIEWER CALL-IN
- 8:00 (2) (2) (2) (11) MOVIE *** "Victory" (1981, Adventure) Sylvester Stallone, Michael Caine.
- 8 ROUTE 66
- 8 15 WASHINGTON WEEK IN REVIEW □
- (4) (4) (4) MR. SUNSHINE Grace convinces Paul to take out an ad in a personal column. (R) □
- 9 NEWS
- 9 17 MIAMI VICE The detectives use a beautiful addict to snare a major league drug dealer. In stereo. (R)
- (7) GREAT PERFORMANCES "Man From Moscow" Wynne goes to Moscow, planning to help Penkovsky get out of Russia before the leak in Soviet security is discovered. (Part 2 of 3) (R) □

- 10 CROOK AND CHASE
- 11 RADIO 1990
- 12 FRIDAY NIGHT VIDEO FIGHTS
- 13 ANIMALS OF THE NORTHWEST
- 14 DR. RUTH SHOW
- 15 SHORTSTORIES "The Garden Party" An encounter with death shatters a young woman's innocence. Beatrice Straight and Jessica Harper star.
- SHOW MOVIE *** "Gremlins" (1984, Fantasy) Zach Galligan, Hoyt Axton.
- 6:30 (8) (8) WALL STREET WEEK "Stockman on Reagan" Guest: former Budget Director David Stockman.
- (4) (4) (4) ABC COMEDY SPECIAL "The Faculty" Six teachers in an urban school system find education no easy task. Blair Brown and Richard McKenzie star. □
- (1) NEWS
- (8) BILL DANA
- (13) VIDEOCOUNTRY



11 p.m. (KMVT, KBCI) **The Heart Is a Lonely Hunter** - Good performances throughout; lift what could have been a forgettable adaptation of Carson McCullers' novel to a higher stature. Alan Arkin is a deaf-mute who helps those around him, despite huge obstacles. Also stars: Cicely Tyson, Stacy Keach, Sondra Locke.

EVERLAST

ENERGY & ALUMINUM CORP.

- Patio Covers
- Carports
- Metal Roofing
- Skirting
- "FOUR-EVER" Insulated Roof.

- ★ Competitive Pricing
- ★ Senior Citizen Discount

- ★ Superior Workmanship
- ★ Insurance Bidding

1630 S. Orchard St. Boise, Idaho 83705

Phone Collect
345-3111

Friday evening programs

6:00 (2) (3) (4) (5) (6) (7) (8) (9) (10) (11)
NEWS

- (1) MY THREE SONS
- (2) BUSINESS REPORT
- (3) WHEEL OF FORTUNE
- (4) PRIMENEWS

(5) WILD, WILD WORLD OF ANIMALS Indian wildlife is virtually unknown to us but it includes some of the most beautiful and spectacular animals on Earth.

(6) (12) BASEBALL Seattle Mariners at Chicago White Sox (Live)

(7) CAMPBELLS After the Campbells arrive at their new home in Canada, a neighbor attempts to drive them off their land.

(8) NEW! ANIMAL WORLD

(9) NASHVILLE NOW

(10) CHAIN REACTION

(11) ENTERTAINMENT TONIGHT Interview with country singer Tanya Tucker.

(12) ARCHIVES OF TIME

(13) CONGRESSIONAL HEARING

(14) AUTO RACING Mint 400 Off-Road Race from Las Vegas. (Taped)

(15) FROM HERE TO ETERNITY

(16) MOVIE ★★ "The Leather Boys" (1966, Drama) Rita Tushingham, Dudley Sutton.

(17) SHOW MOVIE ★★ "The Border" (1981, Drama) Jack Nicholson, Valeria Perrine.

6:30 (2) (3) (4) (11) WHEEL OF FORTUNE

(1) MISTER ED "Ed, The Sentry"
(2) WILD AMERICA A look at the wolverine in its remote and rugged habitat.

(3) JEOPARDY

(4) LET'S GO TO THE RACES

(5) ALICE Alice discovers that one of the diner's regulars may be a gangster.

(6) BUSINESS REPORT

(7) BETWEEN GAMES

(8) M*A*S*H B.J. writes home to his wife reporting Klinger's escape attempts and one of Frank's goof-ups.

(9) DORIS DAY'S BEST FRIENDS Guest: Cleveland Amory.

(10) DONALD DUCK PRESENTS

(11) ALL-STAR BLITZ

(12) PM MAGAZINE Actress Stephanie Zimbalist ("Romington Steele"); the F-20 Tigershark, a new fighter jet.

(13) \$100,000 PYRAMID

(14) PRIME TIME ACCESS

(15) VALLEY OF ICE

7:00 (2) (3) (4) (11) TWILIGHT ZONE Three stories: a bogeyman lurks under a youngster's bed; a boy learns devilish tricks from a rented deocasselto; strange things happen

Daytime movies

5:00 (2) ★ "Thieves" (1977, Comedy) Marlo Thomas, Charles Grodin.

5:30 (TMC) ★★★ "Royal Wedding" (1951, Musical) Fred Astaire, Jane Powell.

5:35 CIN ★★★ "The Westerner" (1940, Western) Gary Cooper, Walter Brennan.

6:40 (SHOW) ★★ "Kelly" (1981, Drama) Robert Logan, Twyla-Dawn Vukina.

6:00 SHOW ★★ "Comfort And Joy" (1984, Comedy) Bill Paterson, Eleanor David.

7:30 HBO ★★ "White Water Sam" (1977, Adventure) Keith Larsen.

(SHOW) ★★ "Dusty" (1981, Drama) Bill Kerr, Noel Trevalthen.

(TMC) ★★ "Vision Quest" (1985, Drama) Matthew Modine, Linda Fiorentino.

8:00 (2) ★★ "Once In Paris" (1978, Drama) Wayne Rogers, Gayle Hunnicutt.

SHOW ★★ "Ride, Vaquero!" (1953, Western) Robert Taylor, Ava Gardner.

8:05 (2) ★★ "Mara Of The Wilderness" (1985, Adventure) Adam West, Linda Saunders.

8:30 CIN ★★ "Dreamscape" (1984, Science Fiction) Dennis Quaid, Max Von Sydow.

9:00 HBO ★★ "The Never-Ending Story" (1984, Fantasy) Noah Hathaway, Barret Oliver.

(SHOW) ★★ "Comfort And Joy" (1984, Comedy) Bill Paterson, Eleanor David.

9:30 (TMC) ★★ "F.I.S.T." (1978, Drama) Sylvester Stallone, Peter Boyle.

10:00 SHOW ★★ "Gremlins" (1984, Fantasy) Zach Galligan, Hoyt Axton.

10:30 (2) ★★ "Jungle Cat" (1960, Documentary) Narrated by Winston Hibler.

CIN ★★ "Pygmalion" (1938, Comedy) Leslie Howard, Wendy Hiller.

11:00 (2) ★★ "The Roaming Cowboy"

(1937, Western) Fred Scott, Al St. John.

HBO ★★ "Conan The Destroyer" (1984, Adventure) Arnold Schwarzenegger, Grace Jones.

(SHOW) ★★ "Ride, Vaquero!" (1953, Western) Robert Taylor, Ava Gardner.

11:05 (2) ★★ "Larry" (1974, Drama) Frederic Forrest, Tyne Daly.

12:00 SHOW ★★ "Comfort And Joy" (1984, Comedy) Bill Paterson, Eleanor David.

(TMC) ★★ "Royal Wedding" (1951, Musical) Fred Astaire, Jane Powell.

12:30 CIN ★★ "Cimarron" (1961, Western) Glenn Ford, Marla Schell.

1:00 (2) ★★ "Sister, Sister" (1982, Drama) Diahann Carroll, Rosalind Cash.

HBO ★★ "Chattanooga Choo Choo" (1984, Comedy) George Kennedy, Joe Namath.

(SHOW) ★★ "Gremlins" (1984, Fantasy) Zach Galligan, Hoyt Axton.

2:00 (2) ★★ "Knight Without Armour" (1937, Adventure) Robert Donat, Marlene Dietrich.

(2) ★★ "Honeymoon" (1968, Romance) Anthony Steel, Ludmilla Tcherna.

(TMC) ★★ "Escape From El Diablo" (1983, Adventure) Jimmy McNichol, Timothy Van Patten.

2:30 SHOW ★★ "Dusty" (1981, Drama) Bill Kerr, Noel Trevalthen.

3:00 (2) ★★ "The Emperor Jones" (1933, Drama) Paul Robeson, Dudley Diggs.

HBO ★★ "9 To 5" (1980, Comedy) Jane Fonda, Dolly Parton.

(SHOW) ★★ "Comfort And Joy" (1984, Comedy) Bill Paterson, Eleanor David.

CIN ★★ "The Little Foxes" (1941, Drama) Bette Davis, Herbert Marshall.

3:30 (TMC) ★★ "Vision Quest" (1985, Drama) Matthew Modine, Linda Fiorentino.

Daytime sports

6:30 (2) SPORTSCENTER
7:00 (2) SPEEDWEEK A weekly report on auto racing.

7:30 (2) WORLD CLASS WOMEN

8:00 (2) AUTO RACING CART Portland 200, from Portland, Ore. (R)

9:30 (2) SPORTSLOOK

11:00 (2) HISTORY OF U.S. OPEN GOLF

11:30 (2) GOLF Crosby Clambake, from Winston-Salem, N.C. (R)

1:30 (2) INSIDE THE PGA TOUR

2:00 (2) PGA SENIORS GOLF Tourna-

ment Players Championship, first round, live from Cleveland.

4:00 (2) BASEBALL Atlanta Braves at Cincinnati Reds (Live)

(2) SPORTSLOOK

4:30 (2) FISHING: MARK BOBBS

SALT WATER JOURNAL

6:00 (2) SPORTSCENTER

6:30 (2) BASEBALL Chicago Cubs at New York Mets (Live)

(2) NFL YEARBOOK 1984 CHICAGO BEARS

BEYOND REPAIR?

Let us make that decision. We do all kinds of lamp and lighting repairs.



- ★ Replacement Glass
- ★ Lamp Shades
- ★ Lamp Repairs

8:30-5:30 Weekdays • 10-3 Saturdays

the lighting center

1920 Kimberly Road

733-1382

SCHEDULED PROGRAMS

| FRIDAY EVENING | | 7:00 | 7:30 | 8:00 | 8:30 | 9:00 | 9:30 | 10:00 | 10:30 | 11:00 | 11:30 | 12:00 | 12:30 |
|----------------|--------------------------------|------------------|------------------|---------------------------------|------------------------------|------------|---------------------|-------------|---------------------------------------|--------------------|------------------|-------|-------|
| 2 | Twilight Zone | Movie: "Victory" | | | | News | | 8. MZBR | Movie: "The Heart is a Lonely Hunter" | | | | |
| 4 | MacNeil / Lehrer | W. Week | Wed St. | Great Performances | | Bodyratic. | | Firing Line | | | | | |
| 6 | Webster | Belvedere | Sunshine | Comedy | | Love Deal | | News | Entertain. | Nightline | Movie | | |
| 7 | Knight Rider | Miami Vice | | Stingray | | News | | Tonight | | Friday Night Video | | | |
| 9 | Baseball Cont'd | | | Movie: "Mother, Jugs And Speed" | | | | Quincy | | Movie | | | |
| 12 | Twilight Zone | Movie: "Victory" | | | | News | | M*A*S*H | Movie: "The Heart is a Lonely Hunter" | | | | |
| SHOW | Movie: "Skins Ahoy" | | | | Movie: "The Border" | | | | | | Movie: "Gremmie" | | |
| SHOW | Movie Cont'd | | Movie: "Gremmie" | | | | Movie: "Caddyshack" | | Movie | | | | |
| HBO | Movie: "Mom, The Woman And Me" | | | | Movie: "Conan The Destroyer" | | | | Movie: "Blood Simple" | | | | |

Friday

- after a man murders his lover's husband. (R)
- 11:30 P
 11:30 MACNEIL / LEHRER NEWS HOUR
 12:00 WEBSTER Webster plays Cupid for George's father and Katherine's aunt. (R) □
 12:30 LARRY KING LIVE
 1:00 KNIGHT RIDER Michael and KITT engaged in a beach battle with The Hovercraft, a roving aquatic arsenal. In stereo. (R)
 1:30 WALL STREET WEEK "Stockman on Reagan" Guest: former Budget Director David Stockman.
 2:00 BASEBALL Atlanta Braves at Cincinnati Reds (Live)
 2:30 700 CLUB
 3:00 MOVIE ★★★ "The Road to Rio" (1947, Comedy) Bing Crosby, Bob Hope.
 3:30 CARTOONS
 4:00 V.J. MARK GOODMAN
 4:30 BALLOONING IN EUROPE
 5:00 TOP RANK BOXING Jimmy Navaro vs. Darryl Thippen in a bantamweight bout scheduled for 12 rounds, live from Atlantic City, N.J.
 5:30 REGIS PHILBIN'S LIFESTYLES
 HBO MOVIE ★★ "Mom, The Woman And Me" (1980, Drama) Pally Duke Astin, David Blimie.
 (SHOW) MOVIE ★★ "Skins Ahoy" (1952, Comedy) Esther Williams, Vivian Blaine.
 (TMC) MOVIE ★ "Night School" (1981, Mystery) Leonard Mann, Rachel Ward.
 CN MOVIE ★★★ "Dreamscape"

- (1984, Science Fiction) Dennis Quaid, Max Von Sydow.
 7:30 (1) (2) (3) MR. BELVEDERE Marsha decides to drop out of law school. (R) □
 (7) WASHINGTON WEEK IN REVIEW □
 (8) NEW COUNTRY
 (9) VIEWER CALL-IN
 8:00 (1) (2) (3) (11) MOVIE ★★★ "Victory" (1981, Adventure) Sylvester Stallone, Michael Caine.
 (1) ROUTE 66
 (1) (2) WASHINGTON WEEK IN REVIEW □
 (4) (5) (6) MR. SUNSHINE Grace convinces Paul to take out an ad in a personals column. (R) □
 (3) NEWS
 (7) (1) (2) MIAMI VICE The detectives use a beautiful addict to snare a major league drug dealer. In stereo. (R)
 (7) GREAT PERFORMANCES "Man From Moscow" Wynne goes to Moscow, planning to help Penkovsky get out of Russia before the leak in Soviet security is discovered. (Part 2 of 3) (1) □

- (8) CROOK AND CHASE
 (9) RADIO 1990
 (1) FRIDAY NIGHT VIDEO FIGHTS
 (2) ANIMALS OF THE NORTHWEST
 (3) DR. RUTH SHOW
 (4) SHORTSTORIES "The Garden Party" An encounter with death shatters a young woman's innocence. Beatrice Straight and Jessica Harper star.
 SHOW MOVIE ★★★ "Gremmie" (1984, Fantasy) Zach Galligan, Hoyt Axton.
 8:30 (1) (2) WALL STREET WEEK "Stockman on Reagan" Guest: former Budget Director David Stockman.
 (3) (4) (5) ABC COMEDY SPECIAL "The Faculty" Six teachers in an urban school system find education no easy task. Blair Brown and Richard McKenzie star. □
 (7) NEWS
 (8) BILL DANA
 (9) VIDEOCOUNTRY



11 p.m. (KMVT, KBCI) **The Heart is a Lonely Hunter**: Good performances throughout lift what could have been a forgettable adaptation of Carson McCullers' novel to a higher stature. Alan Arkin is a deaf-mute who helps those around him, despite huge obstacles. Also stars Cicely Tyson, Stacy Keach, Sondra Locke.

EVERLAST

ENERGY & ALUMINUM CORP.

- Patio Covers
- Carports
- Metal Roofing
- Skirting
- "FOUR-EVER" Insulated Roof.



★ Competitive Pricing

★ Senior Citizen Discount

1630 S. Orchard St.
Boise, Idaho 83705

★ Superior Workmanship

★ Insurance Bidding

Phone Collect
345-3111

Friday

- (15) WILD, WILD WORLD OF ANIMALS**
(16) WILDLIFE CINEMA I
(17) CAMPAIGN '80
9:40 (18) MOUSETRIPE THEATER
9:00 (19) MOVIE ★★ "The Night Has Eyes" (1942, Mystery) James Mason, Joyce Howard.
(20) GREAT PERFORMANCES "Man From Meacock" Wynna goes to Moscow, planning to help Penkovsky get out of Russia before the leak in Soviet security is discovered. (Part 2 of 3) (R) □
(21) LOVE BOAT On a private party wedding cruise, the best man flirts with the bride's sister and a party crasher makes a pass at the bride. Guest stars include Fannie Flagg and Archie Hahn. (R) □
(22) MONEYLINE
(23) STINGRAY Stingray uncovers political dirty dealings while investigating the murder of a cop's wife. In stereo. (R)
(24) TREASURE HOUSES OF BRITAIN Featured: Belvoir Castle; Plas Newydd; Penrhyn Castle, Wales; Wightwick Manor; Lindisfarne Castle, Northumberland; Derbyshire's Harddon Hall. (R) □
(12) MOVIE ★★ "Mother, Jugs And Speed" (1976, Drama) Bill Cosby, Raquel Welch.
(13) BILL COSBY
(14) RETURN TO TREASURE ISLAND "Treasure Island" Long John Silver rescues Jim from Garcia and they set sail with Van Der Brecken for Treasure Island.
(15) YOU CAN BE A STAR
(16) THREE'S A CROWD
(17) TOP 20 VIDEO COUNTDOWN
(18) TOWARDS 2000
(19) MOVIE ★★ "Dirty Knight's Work" (1976, Mystery) John Mills, Donald Pleasence.
(20) HARVEST JAZZ Singer Dexter Gordon and vibraphonist Bobby Hutcherson perform in the continuing celebration of harvest at the Paul Masson Vineyards.
HBO MOVIE ★★ "Conan The Destroyer" (1984, Adventure) Arnold Schwarzenegger, Grace Jones.
(SHOW) MOVIE ★★ "The Border" (1981, Drama) Jack Nicholson, Valerie Perrine.
(TMC) MOVIE ★★ "The Sensuous Nurse" (1979, Comedy) Ursula, Andrea, Duilio Del Prete.
CIN ROCK AND ROLL: THE EARLY DAYS The roots of rock 'n' roll are traced through the careers of Bill Haley, the Everly Brothers, Fats Domino, Buddy Holly, Bo Diddley, Elvis Presley and others.
9:30 (21) SPORTS TONIGHT
(22) NIGHT TRACKS - POWER PLAY In stereo.
(23) TRAPPER JOHN, M.D.
(24) BURNS AND ALLEN Grace reports that her car's been stolen and sends the police on a search.
(25) FANDANGO
(26) MADAMELINE
(27) Q.E.D.
(28) TODAY IN WASHINGTON
(29) SPORTSCENTER
10:00 (30) (1) (4) (5) (6) (7) (8) (9) (10) (11) NEWS

- (11) BODYWATCH** Simple steps to delay the aging process including aerobic exercise and proper diet. Guest: Sen. Claiborne Pell (D-R.I.) □
(4) NEWSNIGHT
(7) NOT THE NINE O'CLOCK NEWS
(1) JACK BENNY Jack tries to get composer Dimitri Tiomkin to write an arrangement for his song.
(12) MOVIE ★★ "Summer Magic" (1963, Musical) Hayley Mills, Burl Ives.
(13) NASHVILLE NOW
(14) STONE
(15) TEN GREEN BOTTLES
(16) AUSTRALIAN RULES FOOTBALL
(17) MOVIE ★★ "The Leather Boys" (1960, Drama) Rita Tushingham, Dudley Sutton.
SHOW MOVIE ★★ "Caddyshack" (1980, Comedy) Bill Murray, Chevy Chase.
CIN BRITISH ROCK: THE FIRST WAVE A montage of clips of The Beatles, The Rolling Stones, The Kinks and The Who highlight this look at the British rock invasion of the mid-60's.
10:30 (2) BARNEY MILLER While off duty, two female detectives go undercover to solve a campus drug case but interfere with Detective Chano's investigation of the matter.
(11) FIRING LINE Guests: U.N. Ambassadors Benjamin Netanyahu (Israel) and Claude de Kemoularia (France).
(1) TONIGHT Host: Johnny Carson. Scheduled: actor Craig T. Nelson ("Pottersgate II"), waitress-columnist Virgie White. In stereo. □
(7) DOCTOR WHO "Genesis Of The Daleks" The Daleks take over the bunker, chanting "Exterminate! Exterminate!" (Part 6 of 6)
(3) NIGHT TRACKS In stereo.
(1) MOVIE ★★ "Elmer Gantry" (1960, Drama) Burt Lancaster, Jean Simmons.
(11) M*A*S*H Hawkeye becomes a villain after his practical joke on Charles goes awry.
(1) BEST OF GROUCHO
(2) ONE TREE ISLAND (TMC) MOVIE ★★ "F.I.S.T." (1976, Drama) Sylvester Stallone, Peter Boyle.
10:35 (1) TAD A couple of cabbies quickly claim responsibility when Elaine begins receiving mysterious love messages.
(1) WKRP IN CINCINNATI
(1) ENTERTAINMENT TONIGHT Interview with country singer Tanya Tucker.
(2) TONIGHT Host: Johnny Carson. Scheduled: actor Craig T. Nelson ("Pottersgate II"), waitress-columnist Virgie White. In stereo.
(1) NIGHTLINE
10:40 (1) M*A*S*H
11:00 (2) (11) MOVIE ★★ "The Heart Is A Lonely Hunter" (1960, Drama) Alan Arkin, Sandra Locke.
(1) MISTER ED "Ed, The Sentry"
(1) CROSSFIRE
(7) MOVIE ★★ "Somebody Up There Likes Me" (1956, Biography) Paul Newman, Pier Angeli.
(12) QUINCY Quincy's investigation into a teen-ager's death leads him into the world of child pornography.
(1) DOBIE GILLIS
(1) GET CHRISTIE LOVE!

- (7) VJ: MARK GOODMAN**
(5) ASIAN INSIGHTS
(1) ROLLER DERBY
(1) EVERYBODY'S MONEY MATTERS
HBO MOVIE ★★ "Blood Simple" (1984, Drama) John Getz, Frances McDormand.
(SHOW) MOVIE ★★ "Gremmie" (1984, Fantasy) Zach Galligan, Hoyt Axton.
CIN MOVIE ★★ "Stardust" (1978, Drama) David Essex, Larry Hagman.
11:05 (1) MOVIE ★★ "The Heart Is A Lonely Hunter" (1960, Drama) Alan Arkin, Sandra Locke.
(2) JEFFERSONS
(3) NIGHTLINE
(1) 700 CLUB
11:15 (1) MOVIE ★★ "The Heart Is A Lonely Hunter" (1960, Drama) Alan Arkin, Sandra Locke.
11:30 (2) DONNA REED Donna's application for a credit card is rejected.
(3) NEWSNIGHT UPDATE
(1) FRIDAY NIGHT VIDEOS "Late Night With David Letterman" band-leader Paul Shaffer and Rolling Stone Keith Richards lead an all-star jam session. In stereo.
(3) NIGHT TRACKS In stereo.
(1) FATHER KNOWS BEST Betty tries out for a dancing part in a college musical.
(1) NEW COUNTRY
11:35 (2) ROCKFORD FILES
(2) MOVIE ★★ "The Kid With The Golden Arm" (1960, Adventure) Sun Chien.
(1) ENTERTAINMENT TONIGHT Interview with country singer Tanya Tucker.
11:40 (2) DTV
11:50 SHOW MOVIE ★★ "Gimme An 'F'" (1984, Comedy) Stephen Shellen, Mark Keyloun.
12:00 (1) ISPY
(12) MOVIE ★★ "The Sweet Ride" (1968, Drama) Tony Franciosa, Michael Sarrazin.
(1) 700 CLUB
(15) ADVENTURES OF OZZIE & HARRIET "Rick Gets Even" An attractive coed's lack of interest in Ricky changes when a dated fender puts her in his debt.
(1) FIRE ON THE MOUNTAIN
(1) NIGHT FLIGHT "Captain Midnight" A teenager (Marvin Ziegler) becomes the most popular disc jockey in Los Angeles and then later evades the law with the help of his loyal teenage audience.

cool/kul/

- moderately cold, protecting from heat.
- Dependable, economical central air conditioning with the **Lennox 8510** will keep your home cool and comfortable this summer.

BRIZEE Heating & Air Conditioning
 "Comfort & Confidence Since 1909"
 227 Second Avenue East 733-8624

Saturday programs

11 MORNING (11:00-12:00)

- 6:00 **POWERHOUSE**
- NEWS / WEATHER / SPORTS**
- CARTOONS**
- A MILLIONAIRE'S SECRET TO WEALTH**
- OUTDOOR LIFE**
- INVESTMENT ADVISORY**
- LOST IN SPACE**
- 6:15 **BUYERS FORUM**
- 6:30 **KIDS WRITES**
- SPORTS CLOSE UP**
- ISSUES UNLIMITED**
- KEYS TO SUCCESS**
- SPORTSCENTER**
- CAN YOU BE THINNER?**
- OUT OF CONTROL**
- 6:00 **PRK PANTHER AND SONS**
- NEWS / WEATHER / SPORTS**
- SNORKS**
- U.S. FARM REPORT**
- (11) WUZLES**
- TO BE ANNOUNCED**
- INSTANT CASH SYSTEMS**
- NIGHT FLIGHT**
- VJ: ALAN HUNTER**
- AUSTRALIAN RULES FOOTBALL**
- MAKING MONEY WITH GOVERNMENT LOANS**
- NANNY**
- HBO RODNEY DANGERFIELD HOSTS THE YOUNG COMEDIANS SPECIAL** Aspiring comedians perform at Dangerfield's in New York.
- SHOW MOVIE** ★★ "The Opposite Sex" (1958, Comedy) June Allyson, Dolores Gray.
- MOVIE** ★★½ "Cold Feet" (1983, Comedy) Griffin Dunne, Marielisa Chibaz.
- 6:06 **WRESTLING**
- 6:30 **(1) (2) (11) BERENSTAIN BEARS**
- BELLE AND SEBASTIAN**
- LITTLES**
- BIG STORY**

- ADVENTURES OF THE GUMMI BEARS**
- WILD KINGDOM**
- CATCH THE SPIRIT** Featured: Ely Ales and Dr. Marsha Goodhead.
- NIGHT FLIGHT**
- TODAY IN WASHINGTON (SHOW): WHITE LIES** Two teen-age girls discover the merits of honesty when little white lies threaten their friendship.
- CIN MOVIE** ★★★ "Rachel And The Stranger" (1948, Drama) Loretta Young, William Holden.
- 7:00 **(1) (2) (11) JIM HENSON'S MUPPETS, BABIES & MONSTERS**
- STAR TREK**
- BUGS BUNNY LOONEY TUNES COMEDY HOUR**
- NEWS UPDATE / HEALTHWEEK**
- SMURFS**
- MASTER ROGERS (R)**
- (12) JEM**
- GARNER TED ARMSTRONG**
- JAMES ROBISON**
- DONALD DUCK PRESENTS**
- AUTO RACING (MCA Ohio Grand Prix from Lexington, Ohio. In stereo.**
- NIGHT FLIGHT**
- VIEWER CALL-IN**
- WORLD CLASS WOMEN**
- INVESTMENT ADVISORY**
- DIANA**
- HBO MOVIE** ★★ "Baby: Secret Of The Lost Legend" (1985, Adventure) William Katt, Sean Young.
- (SHOW) MOVIE** ★★ "Oxford Blues" (1984, Drama) Rob Lowe, Ally Sheedy.
- 7:05 **NATIONAL GEOGRAPHIC EXPLORER**
- 7:30 **MR. WIZARD'S WORLD**
- MONEYWEEK**
- 3-2-1 CONTACT**
- (12) WOODY WOODPECKER**
- MINORITY BUSINESS REPORT**
- ZOLA LEVITY**
- CONTRAPTION**

- TENNIS MAGAZINE REPORTS - (TMC) MOVIE** ★★★ "Up In Arms" (1944, Comedy) Danny Kaye, Dinah Shore.
- 8:00 **(1) (2) (11) HULK HOGAN'S ROCK 'N' WRESTLING**
- LASSE**
- LAFF-A-LYMPICS**
- NEWS UPDATE / SHOWBIZ WEEK**
- SESAME STREET (R)**
- (12) GUNSMOKE**
- CHARLANDO**
- MOVIE** ★★ "More Than Magic" (1955, Western) Clayton Monroe, Jay Silverheels.
- MOUSECISE**
- JIMMY SWAGGART**
- CONGRESSIONAL HEARINGS, PUBLIC POLICY ADDRESS, PRESS CONFERENCE**
- ROLLER DERBY**
- JOURNEY TO ADVENTURE**
- MAELSTROM**
- SHOW MOVIE** ★★½ "The Little Foxes" (1941, Drama) Bette Davis, Herbert Marshall.

Sports Highlights

11 a.m. (NBC) **MAJOR LEAGUE BASEBALL** Regional coverage of either the Detroit Tigers visiting the Brewers at Milwaukee County Stadium or the New York Yankees visiting the Toronto Blue Jays.

12:30 p.m. (ESPN) **PGA SENIORS GOLF: Tournament Players Championship** The top players on the seniors' circuit will get together in Cleveland for the second round of the players' favorite tournament.

2 p.m. (NBC) **WORLD CUP SOCCER: Brazil vs. France** The opening game of the quarterfinals pits perhaps the two strongest teams in the tournament. Brazil is looking for its fourth World Cup since 1962; France had to defeat defending World Cup champion Italy earlier in the week to make its this far.

2:30 p.m. (CBS) **PGA GOLF** Third-round action of the Atlanta Classic live from Marietta, Georgia.

Paul Kalbfleisch

Great Color Console Buy!



Model GLR48
\$449.00

RCA 25" diagonal XL-100 Color TV

- 18-position electronic tuning system
- Automatic line tuning
- Super AccuFilter 110° COTY picture tube
- Utilized XtendedLife chassis

YOU SAVE WHEN YOU DRIVE OUT TO PAUL'S

W 1-1/2 HOURS
H 2-1/2 HOURS
Y 3-1/2 HOURS

PAUL KALBFLEISCH APPLIANCE AND TV SERVICE
1 1/2 miles west of Flor on the Clover Road
734-4142

Saturday

QIN A ROCKABLY SESSION: CARL PERKINS AND FRIENDS George Harrison, Rosanne Cash, Ringo Starr, Dave Edmunds and former members of the Stray Cats gather for a jam session with rock 'n' roll legend Carl Perkins.

6:30 (1) DENNIS THE MENACE
(2) (3) (4) **EWOKS AND DROIDS ADVENTURE HOUR**

(5) **STYLE WITH ELSA KLENSCH**
(6) (7) (8) **PUNKY BREWSTER**
(9) **PEOPLE TO PEOPLE**
(10) **YOU AND ME, KID** Guest: Paul Linke.

(11) **COUNTRY KITCHEN**
(12) **FRANK FIELD TESTS**

HBO BRAINGAMES Viewers are invited to test their mental skills in a series of fast-paced animated games.

9:00 (1) (2) (3) (1) RICHEL RICH
(4) **NICK ROCKS: VIDEO TO GO**
(5) **NEWS UPDATE / SCIENCE TECHNOLOGY WEEK**

(6) (7) (8) **ALVIN AND THE CHIPMUNKS**

(9) **MISTER ROGERS (R)**
(10) (12) **CAN YOU BE THINNER?**
(11) **WORLD TOMORROW**

(13) **DUMBO'S CIRCUS**
(14) **MOVIE ★★ "Silver Spurs" (1943, Western) Roy Rogers, Phyllis Brooks.**

(15) **ALIVE & WELL**
(16) **VJ: ALAN WALTER**

(17) **AUTO RACING** Mini 400 Off-Road Race from Las Vegas. (R)

(18) **WHAT EVERY BABY KNOWS**
(19) **ONE BY ONE**

HBO MOVIE ★★ "Hanky Panky" (1932, Comedy) Gene Wilder, Glida Rauner.

(SHOW) MOVIE ★★★ "The Opposite Sex" (1956, Comedy) June Allyson, Dolores Gray.

CIN MOVIE ★★ "Treasure Of The Four Crowns" (1992, Adventure) Tony Anthony, Ana Obregon.



12:50 p.m. (WTBS) The President's Analyst James Coburn, as the president, creates a furor when he quits the job. As a result, half the government pursues him throughout this nutty, biting 1967 satire. Also starring: Godfrey Cambridge, Will Geer.

8 p.m. (KTRV) The Autobiography of Miss Jane Pittman This television epic was a landmark in the career of Cicely Tyson, who plays a 110-year-old slave in a stirring social drama chronicling the black experience in America, from slavery to the civil rights movement. The film won a whopping nine Emmy Awards in 1974.

9:05 (6) MOVIE ★★ by "Chuk" (1967, Western) Rod Taylor, Ernest Borgnine.

9:30 (1) (2) (3) (11) DUNGEONS & DRAGONS

(4) (5) (6) **SUPER POWERS TEAM: GALACTIC GUARDIANS (1)**

(7) **BASEBALL '86**

(8) (9) (10) **KIDD VIDEO**
(11) **3-2-1 CONTACT (1)**

(12) **CAROL BURNETT AND FRIENDS**

(13) **STAR GAMES**
(14) **WYATT EARP**

(15) **GOOD MORNING MICKEY!**
(16) **A WHOLE NEW YOU (TMC) MOVIE ★★ "Rhinestone" (1984, Comedy) Sylvester Stallone, Dolly Parton.**

10:00 (1) (2) (3) (11) POLE POSITION

(4) **YOU CAN'T DO THAT ON TELEVISION**

(5) (6) (7) **WEEKEND SPECIAL "The Adventures of a Two-Minute Werewolf" A boy (Knowl Johnson) who's a horror movie fan finds himself turning into a werewolf for two-minute periods. (Part 2 of 2) (R) (1)**

(8) **NEWS / WEATHER / SPORTS**

(9) (10) **MR. T**

(11) **SEASIDE STREET (R) (1)**

(12) **QUINSMOKE**

(13) **LARAMEE**

(14) **WELCOME TO POOH CORNER**

(15) **GO FOR YOUR DREAMS: CASH FLO EXPO**

(16) **HORSESHOW** Upperville Jumper Classic, from Upperville, Va. (Taped)

(17) **WORKING MOTHER** Featured: A look at Father's Park Bench, a New York organization that helps men learn more about child-rearing.

(18) **MOVIE ★★ "The Leather Boys" (1968, Drama) Rita Tushingham, Dudley Sutton.**

SHOW MOVIE ★★ "Fletch" (1985, Comedy) Chevy Chase, Joe Don Baker.

10:30 (1) (2) (3) (11) GET ALONG GANG

(4) **LITTLE PRINCE**

(5) **KIDSWORLD**

(6) **EVANS & NOVAK**

(7) (8) **AMERICAN BANDSTAND** Featured: ELO ("Calling America," "So Serious"); Patti Austin ("Gettin' Away With Murder"); video by Kenny Loggins ("Danger Zone").

(9) (10) **SPIDER-MAN AND HIS AMAZING FRIENDS**

(11) **MOVIE ★★ "Whispering Smith" (1948, Western) Alan Ladd, Brenda Marshall.**

(12) **DONALD DUCK PRESENTS**

(13) **WRAP AROUND NASHVILLE**

(14) **WHAT EVERY BABY KNOWS**

11:00 (2) TOM AND JERRY
(3) **BELLE AND SEBASTIAN**
(4) **WUZLEB (1)**

(5) **AMERICAN BANDSTAND** Featured: ELO ("Calling America," "So Serious"); Patti Austin ("Gettin' Away With Murder"); video by Kenny Loggins ("Danger Zone").

(6) **NEWS / WEATHER / SPORTS**

(7) (8) (9) **BASEBALL** Regional coverage of Detroit Tigers at Milwaukee Brewers or New York Yankees at Toronto Blue Jays. (Live).

(10) **MOVIE ★★ "Tales" (1949, Adventure) Susan Hayward, Robert Preston.**

(11) **WILD, WILD WEST**
(12) (13) **LEAVE IT TO BEAVER**

(14) CARRARR STRIP

(15) WIND IN THE WILLOWS

(16) COUNTRYCLIPS

(17) KEYS TO SUCCESS

(18) VJ: MARTHA QUINN

(19) DUKES OF HAZZARD

(20) CONGRESSIONAL HEARINGS, PUBLIC POLICY ADDRESS, PRESS CONFERENCE

(21) REGIS PHILBIN'S LIFESTYLES

HBO MOVIE ★★ "Joey" (1984, Drama) Nall Barry, James Quinn.

(SHOW) MOVIE ★★ "The Little Foxes" (1941, Drama) Bette Davis, Herbert Marshall.

CIN MOVIE ★★ "Just The Way You Are" (1984, Comedy) Kristy McNichol, Michael Ontkean.

11:15 (1) MOVIE ★★ "Three Hours To Kill" (1954, Drama) Dana Andrews, Donna Reed.

11:20 (2) SUPERED

11:30 (1) GILLIGAN'S ISLAND

(2) **LASSIE**

(3) **MUPPETS**

(4) **NEWSMAKER SATURDAY**

(5) **PETS ON PARADE**

(11) MOVIE ★★ "The Brothers Karamazov" (1959, Drama) Maria Schell, Yul Brynner.

(12) MOVIE ★★ "Polyanna" (1960, Drama) Hayley Mills, Jane Wymann.

(13) CRAFTS VIDEO MAGAZINE

(14) GISO KID

(15) PBA BOWLING American Bowling Congress Bud Light Masters Tournament, from Las Vegas. (R)

(TMC) MOVIE ★★ "Reuben, Reuben" (1983, Drama) Tom Conti, Katy McGillis.

AFTERNOON

12:00 (2) CHPS

(3) **CYCLING** World BMX Championship from Whistler, B.C.

(4) **COUSTEAU ODYSSEY**

(5) **WALTONS**

(6) NEWS UPDATE / HEALTHWEEK

(7) BATTLESTAR GALACTICA Apollo uncovers a blackmail plot and finds his own life in danger when he tries to clear Starbuck of a murder charge.

(8) (12) MOVIE ★★ "Made in Paris" (1968, Comedy) Ann-Margret, Louis Jourdan.

(9) COUNTRY NOTES

(10) BEST OF MONEY, MONEY, MONEY

(11) **NEWSMAKERS**

(12) **HOUSE CALLS**

(13) **NURSE**

SHOW MOVIE ★★ "Grease" (1978, Musical) John Travolta, Olivia Newton-John.

12:30 (1) STYLE WITH ELSA KLENSCH
(2) **JAPAN'S GRAND KABUKI IN AMERICA** A behind-the-scenes look at the summer of '86 U.S. tour by a 91-member Kabuki troupe; also a brief overview of Japanese Kabuki theater history and tradition. Host: Dick Cavett.

(3) **MOVIE ★★ "Abbott and Costello Meet The Mummy" (1956, Comedy) Marie Windsor, Michael Ansara.**

(4) **BRANDED**

(5) **CHURCH STREET STATION**

(6) **HOLLYWOOD-INSIDER**

(7) **SPORTSMAN'S FRIEND / HAR-OLD ENSLEY** Harold catches fish and returns them for the fun of it at Bennett Spring State Park, where Missouri's trout release season is in

- full swing.
- 22 DRAG RACING *Gatornationals*
- 23 PGA SENIORS GOLF Tournament Players Championship, second round, live from Cleveland.
- 24 HARVEST JAZZ Singer Dexter Gordon and vibraphonist Bobby Hutcherson perform in the continuing celebration of harvest at the Paul Masson Vineyards.
- 50 5 MOVIE ★★★ "The President's Analyst" (1987, Comedy) James Coburn, Godfrey Cambridge.
- 00 5 BATTLE OF THE MONSTER TRUCKS The biggest monster machines ever created are brought together for an awesome exhibition of truck pulling.
- 5 BMX: WIN WITH THE PROS Motorcycles racing pros discuss BMX riding and safety techniques.
- 1 ST. JUDES CHILDREN'S HOSPITAL
- 4 TO BE ANNOUNCED
- 3 YOUR MONEY
- 4 GENERAL HOSPITAL
- 7 VICTORY GARDEN Progress reports from the southern and eastern gardens; a visit to the Emmaus (Pa.) headquarters of Organic Gardening magazine.
- 1 WILD BILL HICKOCK
- 5 AUTO RACING IMSA Ohio Grand Prix from Lexington, Ohio. In stereo.
- 1 MOVIE ★★½ "In Search Of Dracula" (1976, Biography) Documentary. Hosted by Christopher Lee.
- 5 CAN YOU BE THINNER?
- 5 ODYSSEY
- 14 LAZARUS SYNDROME
- HBO (SHOW) MOVIE ★★½ "Fletch" (1985, Comedy) Chevy Chase, Joe Don Baker.
- CIN MOVIE ★★★ "The Buddy Holly Story" (1978, Biography) Gary Busey, Don Stroud.
- 30 5 SPECIAL REPORT
- 5 EIGHT IS ENOUGH David joins the newspaper as a copy boy, Tommy tries out for football and the girls have a dieting contest.
- 7 DINING IN FRANCE Pierre Salinger explores the French traditions of bread baking and cheese making including a visit to a Macon goat cheese farm.
- 1 RIFLEMAN A U.S. marshal arrives in North Fork, taking an Indian prisoner back East for trial.
- 5 MY CHILDREN ARE DYING
- 7 FOR YEARS TO COME! A look at how computer technology has improved working conditions and productivity.
- 2 SHORTSTORIES "The Garden Party" An encounter with death shatters a young woman's innocence. Beatrice Straight and Jessica Harper star.
- (TMC) MOVIE ★★½ "Harold and Maude" (1971, Comedy) Ruth Gordon, Bud Cort.
- 36 5 EDISON TWINS "Video Vengeance" When Paul decides to get into a movie making career, Annie and Tom find themselves in the middle of an investigation into a doctored video tape.
- 00 5 UNSUNG HEROES Highlights of the 1985 Baja 1000 Off-Road Race with former international champions Rod Hall and Walker Evans. Host: Robert Blake.
- 5 STANDBY... LIGHTS! CAMERA! ACTION!

- 1 BOB NEWHART
- 1 10 IN SEARCH OF THE TROJAN WAR Letters inscribed on clay tablets in East Berlin aid in reconstructing the political crisis surrounding the war; the Hittite emperor's 600-mile journey to the Aegean coast.
- 5 NEWS UPDATE / SPORTS CLOSE-UP
- 7 11 WORLD CUP SOCCER Second Round Match (Taped)
- 7 KEN HOM'S CHINESE COOKERY Sweet corn soup with crabmeat, steamed fish with garlic, spring onions and ginger, shredded chicken with sesame seeds.
- (12) MOVIE ★★½ "A Ticket To Tomahawk" (1950, Western) Dan Dailoy, Anne Baxter.
- 7 SOUL TRAIN
- 1 RIFLEMAN Lucas hires a one-famous marshal as a farm hand.
- 1 MOVIE ★★ "Trenchcoat" (1983, Comedy) Margot Kidder, Robert Hays.
- 11 TOP 20 VIDEO COUNTDOWN
- 7 BABY TEST Host Dr. Frank Field and a panel of experts answer questions regarding the problems and joys of raising children from birth to 3 years.
- 5 BREAKTHROUGHS
- 5 CONGRESSIONAL HEARINGS, PUBLIC POLICY ADDRESS, PRESS CONFERENCE
- 11 MOVIE ★★★ "Mission To Paradise" (1985, Adventure) Kieron Moore, Alexander Knox.
- 5 STAGE: LAST DAY Docudrama encompassing the last days of the American Embassy in Saigon and the steady decline of American political strength in Southeast Asia.
- SHOW SOMETIMES I WONDER After their mother brings home a new baby, two children feel they're unloved nuisances and escape to their grandmother's (Colleen Dewhurst) home.
- 2:30 2 11 12 7 (11) PGA GOLF Atlanta Classic, third round, live from Marietta, Ga.
- 3 4 6 WIDE WORLD OF SPORTS Scheduled: Mark Brand (12-0, 7 KO's) vs. John Munduga (24-0, 18 KO's) in a welterweight bout scheduled for 10 rounds, live from Atlantic City, N.J.; U.S. Outdoor Track and Field Championships, live from Eugene, Ore.
- 5 BIG STORY
- 7 TONY BROWN'S JOURNAL Author Ishmael Reed ("Reckless Eye"

- balling" discusses the role black women writers play in perpetuating the negative male image.
- 11 WAGON TRAIN A battle erupts as four men compete for the same woman (Myra Faye).
- 5 COUNTRY KITCHEN
- 5 NEW TECH TIMES
- 5 RODEO
- 3:00 5 DENNIS THE MENACE
- 11 MAKEOVER
- 5 NEWS / WEATHER / SPORTS
- 7 FIRING LINE Guests: U.N. Ambassador Benjamin Netanyahu (Israel) and Claude de Kerviler (France).
- 5 TV
- 11 MOVIE ★★ "Silver Spurs" (1943, Western) Roy Rogers, Phyllis Brooks.
- 11 MOVIE ★½ "The Woman Who Came Back" (1945, Mystery) Nancy Kelly, John Loder.
- 5 EDGE OF SURVIVAL
- HBO MOVIE ★★ "A Matter Of Life And Death" (1980, Drama) Linda Lavin, Salome Jens.
- (SHOW) MOVIE ★★★ "Grease" (1978, Musical) John Travolta, Olivia Newton-John.
- SHOW MOVIE ★★ "Oxford Blues" (1984, Drama) Rob Lowe, Ally Sheedy.
- (TMC) MOVIE ★★½ "Hambone And Hillie" (1984, Comedy) Lillian Glass, Timothy Bottoms.
- CIN MOVIE ★★★ "My Favorite Wife" (1940, Comedy) Cary Grant, Irene Dunne.
- 3:05 5 FISHIN' WITH ORLANDO WILSON
- 3:25 5 STAGE: WORLD WALK The setting is Spandau prison, where Nazi war criminal Albert Speer, while ostracized by his fellow prisoners, composes his memoirs. Stars Alec McCowen and Ralph Nossek.
- 3:30 5 TURKEY TELEVISION
- 5 COOKING CHAMP
- 5 NEWSMAKER SATURDAY
- 5 PUTTIN' ON THE HITS Lip-synched renditions of Klymaxx's "Meeting in the Ladies Room," Elvis Presley's "Blue Suede Shoes" and The Mary Jane Girls' "In My House." (R)
- 5 DISNEY'S LEGENDS AND HEROES Featured: "Texas John Slaughter: Holster Full Of Law" and "Zorro: Zorro Vs. Cupid."

DIVORCE?

KNOW YOUR RIGHTS

First ½ Hour Consultation
\$20.00

BEITO & CRABTREE

Attorneys

735 North Shoshone • Twin Falls • 734-9622

Saturday

ON A ROCKABILLY SESSION: CARL PERIONS AND FRIENDS George Harrison, Rosanne Cash, Ringo Starr, Dave Edmunds and former members of the Stray Cats gather for a jam session with rock 'n' roll legend Carl Perkins.

6:30 (3) DENNIS THE MENACE
(1) (2) (3) EWOKS AND DROIDS ADVENTURE HOUR

(3) STYLE WITH ELSA KLENSCH
(7) (1) (2) PUNKY BREWSTER
(1) PEOPLE TO PEOPLE
(3) YOU AND ME, KID Guest: Paul Linke.

(3) COUNTRY KITCHEN
(1) FRANK FIELD TESTS
HBO BRAINGAMES Viewers are invited to test their mental skills in a series of fast-paced animated games.

9:00 (1) (2) (3) (11) RICHIE RICH
(2) NICK ROCKS: VIDEO TO GO
(3) NEWS UPDATE / SCIENCE TECHNOLOGY WEEK
(7) (1) (2) ALVIN AND THE CHIPMUNKS

(7) MISTER ROGERS (R)
(3) (12) CAN YOU BE THINNER?
(1) WORLD TOMORROW
(12) DUMBO'S CIRCUS
(12) MOVIE ★★ "Silver Spurs" (1943, Western) Roy Rogers, Phyllis Brooks.

(3) ALIVE & WELL
(12) VJ: ALAN HUNTER
(12) AUTO RACING: Mini 400 Off-Road Race from Las Vegas. (R)
(12) WHAT EVERY BABY KNOWS
(12) ONE BY ONE

HBO MOVIE ★★ "Hanky Panky" (1952, Comedy) Gene Wilder, Gilda Radner.
(SHOW) MOVIE ★★★ "The Opposite Sex" (1950, Comedy) June Allyson, Dolores Gray.
CIN MOVIE ★★ "Treasure Of The Four Crowns" (1982, Adventure) Tony Anthony, Ana Obregon.



12:50 p.m. (WTBS) **The President's Analyst** James Coburn, as the president, creates a furor when he quits the job. As a result, half the government pursues him throughout this nutty, biting 1967 satire. Also starring: Godfrey Cambridge, Will Geer.

8 p.m. (KTRV) **The Autobiography of Miss Jane Pittman** This television epic was a landmark in the career of Cicely Tyson, who plays a 110-year-old slave in a stirring social drama chronicling the black experience in America, from slavery to the civil rights movement. The film won a whopping nine Emmy Awards in 1974.

9:05 (3) MOVIE ★★½ "Chuk" (1967, Western) Rod Taylor, Ernest Borgnine.

9:30 (2) (1) (2) (11) DUNGEONS & DRAGONS
(1) (2) (3) SUPER POWERS TEAM: GALACTIC GUARDIANS (1)
(4) BASEBALL '86
(7) (1) (2) KIDD VIDEO
(7) 3-2-1 CONTACT (1)

(12) CAROL BURNETT AND FRIENDS
(1) STAR GAMES
(1) WYATT EARP
(12) GOOD MORNING MICKEY!
(12) A WHOLE NEW YOU (TMC) MOVIE ★★ "Rhinestone" (1984, Comedy) Sylvester Stallone, Dolly Parton.

10:00 (3) (1) (2) (3) (11) POLE POSITION
(3) YOU CAN'T DO THAT ON TELEVISION
(1) (2) (3) WEEKEND SPECIAL "The Adventures of a Two-Minute Werewolf" A boy (Knowl Johnson) who's a horror movie fan finds himself tumbling into a werewolf for two-minute periods. (Part 2 of 2) (R) (1)

(3) NEWS / WEATHER / SPORTS
(7) (1) (2) MR. T
(7) SESAME STREET (R) (1)
(12) GUNSMOKE
(1) LARAMIE

(12) WELCOME TO POOH CORNER
(12) GO FOR YOUR DREAMS: CASH FLO EXPO
(12) HORSESHOW Upperville Jumper Classic, from Upperville, Va. (Taped)
(12) WORKING MOTHER Featured: A look at Father's Park Bench, a New York organization that helps men learn more about child-rearing.

(12) MOVIE ★★★ "The Leather Boys" (1966, Drama) Rita Tushingham, Dudley Sutton.
SHOW MOVIE ★★½ "Fletch" (1985, Comedy) Chevy Chase, Joe Don Baker.

10:30 (2) (1) (2) (3) (11) GET ALONG GANG
(3) LITTLE PRINCE
(3) KIDSWORLD
(3) EVANS & NOVAK
(3) (3) AMERICAN BANDSTAND Featured: ELO ("Calling America," "So Serious"); Patti Austin ("Gettin' Away With Murder"); video by Kenny Loggins ("Danger Zone").

(1) (1) (2) SPIDER-MAN AND HIS AMAZING FRIENDS
(1) MOVIE ★★★ "Whispering Smith" (1940, Western) Alan Ladd, Brenda Marshall.
(12) DONALD DUCK PRESENTS
(12) WRAP AROUND NASHVILLE
(12) WHAT EVERY BABY KNOWS

11:00 (3) (1) (2) (3) (11) TOM AND JERRY
(1) BELLE AND SEBASTIAN
(1) WUZLES (1)
(12) AMERICAN BANDSTAND Featured: ELO ("Calling America," "So Serious"); Patti Austin ("Gettin' Away With Murder"); video by Kenny Loggins ("Danger Zone").

(12) NEWS / WEATHER / SPORTS
(7) (1) (2) BASEBALL Regional coverage of Detroit Tigers at Milwaukee Brewers or New York Yankees at Toronto Blue Jays. (Live)
(12) MOVIE ★★½ "Tulsa" (1949, Adventure) Susan Hayward, Robert Preston.

(12) WILD, WILD WEST
(12) (11) LEAVE IT TO BEAVER

(11) MARRON STRIP
(12) WIND IN THE WILLOWS
(12) COUNTRYCLIPS
(12) KEYS TO SUCCESS
(12) VJ: MARTHA CURRIE
(12) DUKES OF HAZZARD
(12) CONGRESSIONAL HEARINGS, PUBLIC POLICY ADDRESS, PRESS CONFERENCE
(12) REGIS PHILBIN'S LIFESTYLES
HBO MOVIE ★★½ "Joey" (1985, Drama) Neil Barry, James Quinn.
(SHOW) MOVIE ★★½ "The Little Foxes" (1941, Drama) Bette Davis, Herbert Marshall.

CIN MOVIE ★★ "Just The Way You Are" (1984, Comedy) Kristy McNichol, Michael Ontkean.

11:16 (12) MOVIE ★★½ "Three Hours To Kill" (1954, Drama) Dana Andrews, Donna Reed.

11:20 (12) SUPERTED
11:30 (7) GILLIGAN'S ISLAND
(12) LASSIE
(12) MUPPETS
(12) NEWSMAKER SATURDAY
(12) PETS ON PARADE
(12) (11) MOVIE ★★★ "The Brothers Karamazov" (1958, Drama) Maria Schell, Yul Brynner.

(12) MOVIE ★★★ "Polyanna" (1960, Drama) Hayley Mills, Jane Wyman.
(12) CRAFTS VIDEO MAGAZINE
(6) CISCO KID
(12) PBA BOWLING American Bowling Congress Bud Light Masters Tournament, from Las Vegas. (R)
(TMC) MOVIE ★★½ "Reuben, Reuben" (1983, Drama) Tom Conti, Kelly McGillis.

AFTERNOON

12:00 (3) CHPS
(12) CYCLING World BMX Championship from Whittier, B.C.
(12) COUSTEAU ODYSSEY
(12) WALTONS

(12) NEWS UPDATE / HEALTHWEEK
(12) BATTLESTAR GALACTICA Apollo uncovers a blackmail plot and finds his own life in danger when he tries to clear Starbuck of a murder charge.
(12) (12) MOVIE ★★ "Made in Paris" (1966, Comedy) Ann-Margret, Louis Jourdan.

(12) COUNTRY NOTES
(12) BEST OF MONEY, MONEY, MONEY
(12) NEWSMAKERS
(12) SHOW CALLS
(12) NURSE

SHOW MOVIE ★★★ "Grease" (1978, Musical) John Travolta, Olivia Newton-John.
12:30 (12) STYLE WITH ELSA KLENSCH
(7) JAPAN'S GRAND KABUKI IN AMERICA A behind-the-scenes look at the summer of '85 U.S. tour by a 91-member Kabuki troupe; also a brief overview of Japanese Kabuki theater history and tradition. Host: Dick Cavalli.

(12) MOVIE ★★ "Abbott And Costello Meet The Mummy" (1955, Comedy) Melvyn Frank, Michael Ansara.
(12) BRANDED
(12) CHURCH STREET STATION
(12) HOLLYWOOD INSIDER
(12) SPORTSMAN'S FRIEND / HAR-OLD ENSLEY Harold catches fish and returns them for the fun of it at Bennett Spring State Park, where Misouri's trout release season is in

full swing.

(12) WILD, WILD WEST
(12) (11) LEAVE IT TO BEAVER

14 Times-News, Twin Falls, Idaho, Friday, June 20, 1986

full swing.
23 DRAG RACING Internationals
24 PGA SENIORS GOLF Tournament Players Championship, second round, live from Cleveland.
25 HARVEST JAZZ Singer Dexter Gordon and vibraphonist Bobby Hutcherson perform in the continuing celebration of harvest at the Paul Maason Vineyards.

2:50 6 MOVIE ★★★ "The President's Analyst" (1987, Comedy) James Coburn, Godfrey Cambridge.

1:00 8 BATTLE OF THE MONSTER TRUCKS The biggest monster machines ever created are brought together for an awesome exhibition of truck pulling.

9 BMX: WIN WITH THE PROS Motocross racing pros discuss BMX riding and safety techniques.

10 ST. JUDES CHILDREN'S HOSPITAL

11 YOUR MONEY

12 GENERAL HOSPITAL

13 VICTORY GARDEN Progress reports from the southern and eastern gardens; a visit to the Emmaus (Pa.) headquarters of Organic Gardening magazine.

14 WILD BILL HICKOCK

15 AUTO RACING IMSA Ohio Grand Prix from Lexington, Ohio. In stereo.

16 MOVIE ★★½ "In Search Of Oracula" (1976, Biography) Documentary. Hosted by Christopher Lee.

17 CAN YOU BE THINNER?

18 ODYSSEY

19 LAZARUS SYNDROME

HBO (SHOW) MOVIE ★★½ "Fletch" (1985, Comedy) Chevy Chase, Joe Don Baker.

CIN MOVIE ★★★ "The Buddy Holly Story" (1978, Biography) Gary Busey, Don Stroud.

1:30 3 SPECIAL REPORT

4 EIGHT IS ENOUGH David joins the newspaper as a copy boy. Tommy tries out for football and the girls have a dating contest.

5 DINING IN FRANCE Pierre Selinger explores the French traditions of bread baking and cheese making including a visit to a Macon goat cheese farm.

6 RIFLEMAN A U.S. marshal arrives in North Fork, taking an Indian prisoner back East for trial.

7 MY CHILDREN ARE DYING

8 FOR YEARS TO COME! A look at how computer technology has improved working conditions and productivity.

9 SHORTSTORIES "The Garden Party" An encounter with death shelters a young woman's innocence. Beatrice Straight and Jessica Harper star.

(TMC) MOVIE ★★★★★ "Harold and Maude" (1971, Comedy) Ruth Gordon, Bud Cort.

1:35 10 EDISON TWINS "Video Vengeance" When Paul decides to get into a movie making career, Annie and Tom find themselves in the middle of an investigation into a doctored video tape.

2:00 11 UNSUNG HEROES Highlights of the 1985 Baja 1000 Off-Road Race with former international champions Rod Hall and Walker Evans. Host: Robert Blake.

12 STANDBY... LIGHTS! CAMERA! ACTION!

3 BOB NEWHART
4 10 IN SEARCH OF THE TROJAN WAR Letters inscribed on clay tablets in East Berlin aid in reconstructing the political crisis surrounding the war; the Hittite emperor's 600-mile journey to the Aegean coast.

5 NEWS UPDATE / SPORTS CLOSE-UP

6 11 WORLD CUP SOCCER Second Round Match (Taped)

7 KEN HOM'S CHINESE COOKERY Sweet corn soup with crabmeat, steamed fish with garlic, spring onions and ginger, shredded chicken with sesame seeds.

8 (12) MOVIE ★★½ "A Ticket To Tomahawk" (1950, Western) Dan Dailey, Anne Baxter.

9 SOUL TRAIN

10 RIFLEMAN Lucas hires a once-famous marshal as a farm hand.

11 MOVIE ★★ "Trenchcoat" (1983, Comedy) Margot Kidder, Robert Hays.

12 TOP 20 VIDEO COUNTDOWN

13 BABY TEST Host Dr. Frank Field and a panel of experts answer questions regarding the problems and joys of raising children from birth to 3 years.

14 BREAKTHROUGHS

15 CONGRESSIONAL HEARINGS, PUBLIC POLICY ADDRESS, PRESS CONFERENCE

16 MOVIE ★★★ "Mission To Paradise" (1966, Adventure) Kieron Moore, Alexander Knox.

17 STAGE: LAST DAY Docudrama encompassing the last days of the American Embassy in Saigon and the steady decline of American political strength in Southeast Asia.

SHOW SOMETIMES I WONDER After their mother brings home a new baby, two children feel they're unloved grandchildren and escape to their grandmother's (Colleen Dewhurst) home.

2:00 2 3 4 5 6 7 8 9 10 11 PGA GOLF Atlanta Classic, third round, live from Marietta, Ga.

12 13 14 WIDE WORLD OF SPORTS Scheduled: Mark Breland (12-0, 7 KOa) vs. John Munduga (24-0, 18 KOa) in a welterweight bout scheduled for 10 rounds, live from Atlantic City, N.J.; U.S. Outdoor Track and Field Championships, live from Eugene, Ore.

15 BIG STORY

16 TONY BROWN'S JOURNAL Author Lehman Reed ("Reckless Eye")

balling") discusses the role black women writers play in perpetuating the negative male image.

11 WAGON TRAIN A battle erupts as four men compete for the same woman (Myrna Fahy).

12 COUNTRY KITCHEN

13 NEW TECH TIMES

14 RODEO

3:00 5 DENNIS THE MENACE

6 MAKEOVER

7 NEWS / WEATHER / SPORTS

8 FIRING LINE Guests: U.N. Ambassador Benjamin Netanyahu (Israel) and Claude de Menthourier (France).

9 FTV

10 MOVIE ★★ "Silver Spurs" (1943, Western) Roy Rogers, Phyllis Brooks.

11 MOVIE ★½ "The Woman Who Came Back" (1945, Mystery) Nancy Kelly, John Loder.

12 EDGE OF SURVIVAL

HBO MOVIE ★★ "A Matter Of Life And Death" (1980, Drama) Linda Lavin, Salome Jens.

(SHOW) MOVIE ★★★ "Grease" (1978, Musical) John Travolta, Olivia Newton-John.

SHOW MOVIE ★★ "Oxford Blues" (1984, Drama) Rob Lowe, Ally Sheedy.

(TMC) MOVIE ★★½ "Hambone And Hillie" (1984, Comedy) Lillian Gish, Timothy Bottoms.

CIN MOVIE ★★★ "My Favorite Wife" (1940, Comedy) Cary Grant, Irene Dunne.

3:05 13 FISHN' WITH ORLANDO WILSON

3:25 14 STAGE: WORLD WALK The setting is Spandau prison, where Nazi war criminal Albert Speer, while ostracized by his fellow prisoners, composes his memoirs. Stars Alec McCowen and Ralph Nossek.

3:30 15 TURKEY TELEVISION

16 COOKING CHAMP

17 NEWSMAKER SATURDAY

18 PUTTING ON THE HTS Lip-synched renditions of Klymaxx's "Meeting in the Ladies Room," Elvia Presley's "Disco Suede Shoga" and The Mary Jane Girls' "In My House." (R)

19 DISNEY'S LEGENDS AND HEROES Featured: "Texas John Slaughter; Holster; Full Of Law" and "Zorro: Zorro Vs. Cupid."

DIVORCE? KNOW YOUR RIGHTS

First 1/2 Hour Consultation
\$20.00

BEITO & CRABTREE

Attorneys

735 North Shoshone | Twin Falls | 734-9622

Saturday

- 1 SURFING Men's World Cup, from Oahu, Hawaii. (Taped)
- 3:35 2 MOTORWEEK ILLUSTRATED
- 4:05 2 DUKES OF HAZZARD
- 4 OUT OF CONTROL
- 4 FOCUS
- 5 10 RAININ' IN MY HEART: A BLUES MOSAIC The development of the Southern blues sound is traced through the words and music of 10 Louisiana bluesmen whose interpretations range from the downhome, backyard country music of Silas Hogan and Arthur "Guitar" Kelly to the electric funk of Buddy Guy.
- 4 4 ABC NEWS
- 5 NEWS / WEATHER / SPORTS
- 6 FISHING THE WEST Homer, Alaska Halibut, Joe Langston demonstrates the advantages of using the "circle hook" to land Halibut in Alaska's Majestic Cook Inlet.
- 7 LIFESTYLES OF THE RICH AND FAMOUS
- 7 HOUSE FOR ALL SEASONS Tour of a Massachusetts solar apartment house and weatherization project.
- 8 17 WILD KINGDOM Marlin Perkins tracks down a moose in the Canadian province of Saskatchewan. (R)
- 9 (12) WILD, WILD WEST West and Grand join a wagon train of entertainers in their search for a mysterious assassin.
- 10 FAME An irate student (Kenneth Ransom) sparks racial dissension when he voices disapproval over his role as Jim in the play "Huck Finn." In stereo. (R)
- 11 (11) FISHING THE WEST
- 11 GUNSMOKE
- 12 V.J. MARK GOODMAN
- 12 ROUNDTABLE
- 13 DETENTION AT THE GOVERNMENT'S PLEASURE
- 13 VIEWER CALL-IN
- 13 NFL SUPERSTARS Featured: Legend of the Lonely End.
- 13 MOVIE ★★½ "Dirty Knight's Work" (1976, Mystery) John Mills, Donald Pleasence.
- 4:05 2 WRESTLING
- 4:30 2 STAR TREK
- 4 2 11 CBS NEWS
- 4 HOLLYWOOD CLOSEUP Scheduled: the moving experience -- from the elegant theaters of the past to those of today and the future.
- 5 PINNACLE Guest: Nathan Ancell, Chmn. Elhan Allen.
- 5 ABC NEWS
- 7 THIS OLD HOUSE The attic's roof is shingled, skylights and windows are installed; Bob Vila tours Manhattan's Trump Tower. (R)
- 7 11 NBC NEWS
- 8 COUNTRYCLIPS
- 8 LORNE GREENE'S NEW WILDERNESS In East Africa, a termite colony sets out to protect itself from a 160-pound aardvark and an army of deadly ants. (R)
- 8 SPORTSCENTER
- 8 SOAPS, LUCY, THE HILL AND YOU Experts at the 5th International Conference of Television Drama reveal their views on television programming.
- (TMC) FILM FEATURE
- CIN MOVIE ★★½ "Tender Mercies" (1982, Drama) Robert Duvall,

- Teas Harper.
- 5:00 2 CBS NEWS
- 5 1 YOU CAN'T DO THAT ON TELEVISION
- 11 BIG VALLEY Jarrod and Nick rescue an injured man from some cold-blooded bounty hunters.
- 11 10 VISIBLE TARGET Photos, newsreel footage and the personal memories of Bainbridge Island (Wash.) residents recall the effects of the World War II internment of the town's Japanese-Americans and the Bainbridge Review's publishers opposition to the action. (R)
- 11 2 SOLID GOLD Scheduled: Mac Davis (co-host), Whitney Houston, John Waldo, Robin Gibb, Cameo, the Judds, Kenny Loggins (interview). In stereo. (R)
- 11 NEWS UPDATE / SPORTS SATURDAY
- 11 BOSOM BUDDIES After having a late dinner at the home of their boss, Henry and Kip conclude that she's lonely.
- 11 NEWS
- 11 CATS AND DOGS Genetics: making hotel and airline reservations while traveling with a pet; identifying plants toxic to cats. (R)
- 11 BASEBALL Atlanta Braves at Cincinnati Reds (Live)
- 11 FAME An irate student (Kenneth Ransom) sparks racial dissension when he voices disapproval over his role as Jim in the play "Huck Finn." In stereo. (R)
- 11 (12) CHARLIE'S ANGELS The Angels infiltrate a singles club when an innocent patron is murdered.
- 11 IT'S A LIVING The girls recall comical stories about some of the men they had the misfortune of knowing. (R)
- 11 (11) VIEWS
- 11 CAMPBELLS John and Emma try to get rid of their superstitious housekeeper by setting up pranks to scare her away.
- 11 MOVIE ★★½ "The Secret Of N.I.M.H." (1982, Fantasy) Animated. Voices of Elizabeth Hartman, Dom DeLuise.
- 11 DICK CAVETT Guests: Eddie Murphy, Paul Schrader.
- 11 THREE'S COMPANY The roommates spend a weekend at Cindy's aunt's farm.
- 11 HEE HAW
- 11 HUMAN FOIBLE
- 11 FOCUS ON FOREIGN POLICY
- 11 FISHIN' HOLE
- 11 ANNA OF THE FIVE TOWNS Corruption and greed abound in this tale of the 19th-century world of Britain's pottery industry. (Part 1 of 4)
- HBO MOVIE ★★ "Baby: Secret Of The Lost Legend" (1985, Adventure) William Katt, Sean Young.
- (SHOW) SOMETIMES I WONDER After their mother brings home a new baby, two children feel they're unloved nuisances and escape to their grandmother's (Colleen Dewhurst) home.
- SHOW JOHN FOGERTY'S ALL STARS In this 1985 Hollywood concert, John Fogerty performs selections from his new album "Centerfield" and sings hits associated with his former group Creedence Clearwater Revival. In stereo. (R)
- (TMC) MOVIE ★★½ "Up In Arms" (1944, Comedy) Danny Kaye, Dinah

- Shore.
- 5:30 2 NEWS
- 2 DANGER MOUSE
- 11 JAPAN'S GRAND KABUKI IN AMERICA A behind-the-scenes look at the summer of '85 U.S. tour by a 91-member Kabuki troupe; also a brief overview of Japanese Kabuki theater history and tradition. Host: Dick Cavett.
- 11 INVESTIGATIVE REPORT
- 11 SMALL WONDER Executives from a large computer firm plan to kidnap Vicki when they discover she's more of a computer than a child.
- 7 NBC NEWS
- 7 WILD AMERICA Marty Stauffer demonstrates the difficulties, dangers and satisfactions of filming wildlife. (R)
- 7 AT THE MOVIES Scheduled reviews: "Legal Eagles" (Robert Redford, Debra Winger, Daryl Hannah); "Dress to Impress" (Helen Shaver, Patricia Richardson); "Spring Symphony" (Nastassja Kinski).
- 11 (11) ENTERTAINMENT THIS WEEK An interview with Bruce Boxelner.
- 11 GUNS OF WILL SONNETT
- 11 COUNTRY NOTES
- 11 TED KNIGHT SHOW Henry, Monroe, Muriel and Mrs. Sinyon (Pat Carroll) want to help a Vietnamese family find the American Dream.
- 11 WHCKER'S WORLD

EVENING

- 6:00 2 4 WHEEL OF FORTUNE
- 2 MY THREE SONS
- 2 STARKY AND HUTCH Starky risks his life while posing as a cabbie to capture a killer who has slain four drivers in a vendetta against a taxi company.
- 2 10 JACKSONVILLE JAZZ FESTIVAL Performances by Tito Puente and his Latin Jazz Ensemble, the Art Farmer-Benny Golson Jazzlet, the Ross Tompkins Trio, and the Duke Ellington Orchestra with Mercer Ellington and singer Anita Moore. Taped October 5, 1985 at the Florida National Pavilion in Jacksonville.
- 2 NEWS / WEATHER / SPORTS
- 2 ENTERTAINMENT THIS WEEK An interview with Bruce Boxelner.
- 2 HEE HAW Guest: Louise Mandrell, Del Reeves, Danny Darst. (R)
- 2 NATURE OF THINGS
- 2 BLACK SHEEP SQUADRON After a captured Navy airman (Kest McCord) is brainwashed into destroying Marine leaders, he's placed in Peppy's group.
- 2 (12) PUTTIN' ON THE HITS Up-synched renditions of Klymaxx's "Meeting in the Ladies Room," Elkie Slesley's "Blue Suede Shoes" and The Mary Jane Girls' "In My House." (R)
- 2 MOVIE: ★★ "Blusboard" (1972, Drama) Richard Burton, Raquel Welch.
- 11 AMERICA'S JUNIOR MISS Live from Mobile, Alabama, the 29th annual pageant features 52 high school seniors judged on scholastic achievement, creative ability, performing arts, physical fitness and an interview. Five former Junior Miss winners act as judges.
- 11 GRAND OLE OPRY LIVE

SATURDAY EVENING

| | 7:00 | 7:30 | 8:00 | 8:30 | 9:00 | 9:30 | 10:00 | 10:30 | 11:00 | 11:30 | 12:00 | 12:30 |
|------|------------------------------------|-------------------|-----------------|--------------------------|------------------------------------|----------|------------|-------------------------------|-----------------|-----------------|-------|-------|
| 2 | Movie: "The Scarlet And The Black" | | | | | | Taxi | Movie: "The Boys From Brazil" | | | | |
| 4 | Of Nature | America | All Creatures | Mystery! | | Maturity | | Austin City Limits | | | | |
| 6 | Strokes | Benson | Movie | | News | | | Be Thin. | Movie: "Boh" | | | |
| 7 | Facts | 227 | G. Girls | Me & Mrs. | Romington Steele | | News | David Letterman Special | | Movies | | |
| 9 | Star Games | | Movie | | Movie | | | Movie | | | | |
| 12 | Movie: "The Scarlet And The Black" | | | | | | News | Switch | | Video Countdown | | |
| SHOW | Movie Cont'd | | John Fogerty | | Movie: "Grease" | | | Movie: "Fletch" | | | | |
| SHOW | Movie Cont'd | | Movie: "Fletch" | | Movie: "Pope Of Greenwich Village" | | | Movie | | | | |
| HBO | Survival | Movie: "Airplane" | | Movie: "Lost In America" | | | Hitchhiker | Bob Dylan | Movie: "Fletch" | | | |

- 12 CARTOONS
- 12 NEWS
- 4 STAR SEARCH Guest: Audrey Landers. In stereo. (R)
- 6 DISAPPEARING WORLD
- 12 WASHINGTON SEMINAR
- 12 AMATEUR BOXING Golden Gloves Competition, from Cedar Rapids, Iowa. (Taped)
- 12 WORKING MOTHER Featured: an interview with Anne Basso, who lives off the land and uses the barter system; Lynn St. James, race car expert, gives automotive tips.
- 7 MOVIE ★★½ "A Run For Your Money" (1940, Comedy) Alec Guinness, Donald Houston.

- (SHOW) MOVIE ★★ "Oxford Blues" (1984, Drama) Rob Lowe, Ally Sheedy.
- SHOW MOVIE ★★★ "Grease" (1978, Musical) John Travolta, Olivia Newton-John.
- CIN MOVIE ★★½ "The Philadelphia Experiment" (1984, Science Fiction) Michael Pare, Nancy Allen.

- 6:30 7 4 JEOPARDY
- 8 MISTER ED "Ed's Diction Teacher"
- 12 (12) FTV Series regular Stephen Bishop performs "Separate Lives." (R)
- 12 (11) WHEEL OF FORTUNE
- 12 DISNEY CHANNEL PREVIEW
- 12 CHURCH STREET STATION
- 7 SMALL WONDER Executives from a large computer firm plan to kidnap Vicki when they discover she's more of a computer than a child.

- 12 DIMENSION FIVE
- 12 A WHOLE NEW YOU
- HBO SURVIVAL "Orangutans: Orphans Of The Wild" Peter Ustinov narrates a look at the orangutan and the efforts being made to save the species from extinction.

- 7:00 7 7 7 (11) MOVIE ★★½ "The Scarlet And The Black" (1983, Drama) Gregory Peck, Christopher Plummer.

- 1 MOVIE ★★½ "The Big Trees" (1952, Western) Kirk Douglas, Eve Miller.

- 12 12 PROFILES OF NATURE
- 4 6 12 DIFFERENT STROKES Instead of reading "A Tale of Two Cities," Arnold, Charlie and Dudley rely on a plot-summary book. (R) □

- 12 NEWS UPDATE / SHOWBIZ WEEK

- 12 12 12 FACTS OF LIFE The girls help the police break a counterfeiting ring. In stereo. (R) □

- 12 NATURE A survey of birds that cannot fly, some of which have evolved highly efficient means of travel on land or water. (R) □

- 12 (12) STAR GAMES Sports competition featuring cast members from "Falcon Crest," "Days of Our Lives" and "General Hospital." Final round. (R)

- 12 MOVIE ★★½ "The Girl Most Likely" (1957, Musical) Jane Powell, Cliff Robertson.

- 12 ADVENTURES OF OZZIE AND HARRIET

- 12 AUTO RACING IMSA Ohio Grand Prix from Lexington, Ohio. In stereo.

Saturday

- 12 DANCIN' USA
- 12 VJ: MARK GOODMAN
- 12 JOURNEY INTO INDIA
- 12 JOURNALISTS ROUNDTABLE DISCUSSION
- 12 KARATEMANIA: THE BATTLE OF ATLANTA
- 12 JOURNEY TO ADVENTURE "South Pacific Odyssey" A visit to the frontier continent of Australia and the islands of Tahiti, Fiji, American Samoa, and New Zealand.

SALE ADJUSTABLE ELECTRIC BEDS

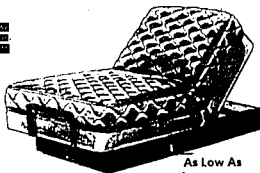

As Low As
\$599



ADJUSTA-MAGIC

SINGLE FOLD
ELECTRIC ADJUSTABLE BED

Now you can save money on an adjustable electric bed. Our Adjusta-Magic single fold beds are just right for many homes. At the flick of a switch the head section will incline or recline to the exact angle most comfortable for you...for reading, writing, watching TV or just relaxing. This is today's way of reducing stress at the end of the day or any other time. And Adjusta-Magic adjustable electric beds are great for sleeping when in the horizontal position.

Come in and let us demonstrate for you. No obligation.

It's not what you save, but what you pay that counts.
And you pay less because you buy factory direct.

90 Days Same As Cash On Approved Credit
326 2nd Avenue South, Twin Falls

733-3312

Open Mon. - Fri. 9:00 to 5:00; Sat. 10:00 to 3:00

EVERTON
The Sleep Center

MATTRESS FACTORY

Saturday

(TMC) MOVIE ★★ "Porky's" (1981, Comedy) Dan Mephan, Mark Herrin.

7:30 (4) (5) WILD AMERICA A look at the ways a variety of fish adapt to their environment in North American waters. (4)

(4) (5) (6) BENSON On a business trip overseas, Benson and Kraus are accused of being spies. (R) (4)

(4) THIS WEEK IN JAPAN
 (7) (8) (9) 227 Mary and Lester attend a Washington Redskins football game. In stereo. (R)

(10) STILL THE BEAVER "Paper Tiger" Oliver's chance of gaining more self-esteem is threatened when a fellow competitor in the school paper drive uses unfair tactics.

(11) HANDS
 (12) FAMILY GUIDE PRESENTS
 HBO MOVIE ★★★ "Airplane!" (1980, Comedy) Robert Hays, Julia Hagerty.

7:45 (4) - PORTRAIT OF AMERICA: SOUTHERN CALIFORNIA Featured: Kurt Wagner, a Hollywood plastic surgeon; a look at the carefully orchestrated landscape; Barbara Reynolds, founder of the "Center Of Hope."

8:00 (4) (5) ALL CREATURES GREAT AND SMALL II "Matters Of Life And Death" James performs a routine task that leads to a shattering event.
 (4) (5) (6) MOVIE ★★★ "The Execution of Raymond Graham" (1985, Drama) Jeff Fahy, Philip Sterling.
 (7) NEWS / WEATHER / SPORTS
 (8) (9) (10) GOLDEN GIRLS Blanche's worldly niece causes embarrassment for the girls. In stereo. (R)
 (11) GREAT RAILWAY JOURNEYS OF THE WORLD Brian Thompson sets off from Bombay's Victoria Terminus for a five-day trip across the Deccan Plain and up into the Nilgiri Mountains.
 (12) MOVIE ★★★ "The Autobiography of Miss Jane Pittman" (1974, Drama) Cicely Tyson, Odette.
 (9) NEWS
 (10) MOVIE ★★ "Superdad" (1974, Comedy) Bob Crane, Barbara Rush.
 (11) THREE'S A CROWD
 (12) JOHN LAW'S WORLD
 (13) CHRISTIAN LIFESTYLE MAGAZINE
 (14) MOVIE ★★ "Kid Millions" (1935, Comedy) Eddie Cantor, Ethel Merman.
 (SHOW) JOHN FOGERTY'S ALL STARS In this 1985 Hollywood concert, John Fogerty performs selections from his new album "Centerfield" and sings hits associated with his former group Creedence Clearwater Revival. In stereo. (4)
 (SHOW) MOVIE ★★ "Flick" (1985, Comedy) Chevy Chase, Joe Don Baker.
 CIN A ROCKABILLY SESSION: CARL PERKINS AND FRIENDS George Harrison, Rosanne Cash, Ringo Starr, Dave Edmunds and former members of the Stray Cats gather for a jam session with rock 'n' roll legend Carl Perkins.
 8:30 (4) (5) ME AND MRS. C. (Premiere) To improve her financial status, an older woman takes in an em-

ployed, ex-convict boarder. Stars: Peg Murray, Misha McK. In stereo. (4)

(15) COUNTRY KITCHEN
 (16) COVER STORY Featured: Alan Thicke discusses his new "situation" comedy "Growing Pains."
 (17) U.S. HOUSE OF REPRESENTATIVES FLOOR DEBATE
 (18) WORLD TOMORROW
 8:45 (4) NIGHT TRACKS: CHARTBUSTERS In stereo.
 9:00 (4) ROUTE 66
 (5) MYSTERY! "Agatha Christie's Partners in Crime" Tommy and Tuppence Beresford investigate the murder of a masked woman during a lovers rendezvous at a nightclub. (R) (4)
 (6) PINNACLE Guest: Nathan Aschell, Chmn. Ethan Allen.
 (7) (8) REMINGTON STEELE Laura and Remington investigate when a Steele impostor turns up "dead" in the county morgue. In stereo. (R)
 (9) AUSTIN CITY LIMITS Featured: Jonny Rodriguez ("Foolin'"; "How Cool I Love Her So Much"); David Allan Coe ("The Ride").
 (10) TWILIGHT ZONE Convicted of murder, a man is sent to a deserted asteroid in space to serve a 40-year "jail" term.
 (11) SUCCESS 'N' LIFE
 (12) COUNTRYCLIPS
 (13) MOVIE ★★ "The Children" (1980, Horror) Martin Shaker, Gil Rogers.
 (14) TOMMY KEENE & LLOYD COLE AND THE COMMOTIONS The World nightclub in New York City is the setting for this concert special featuring Tommy Keene with selections from his debut album "Songs From Film," and Lloyd Cole & The Commotions performing some of their British hits including "Perfect Blue" and "Brand New Friend."
 (15) VISTA
 (16) SPORTSCENTER
 (17) JIMMY SWAGGART
 HBO MOVIE ★★ "Lost In America" (1985, Comedy) Albert Brooks, Julia Hagerty.
 (SHOW) MOVIE ★★ "Grease" (1978, Musical) John Travolta, Olivia Newton-John.
 (TMC) MOVIE ★★★ "Harold And Maude" (1971, Comedy) Ruth Gordon, Bud Cort.
 CIN MOVIE ★★ "The Buddy Holly Story" (1978, Biography) Gary Busey, Don Stroud.
 9:30 (4) SPORTS TONIGHT
 (5) LIFESTYLES OF THE RICH AND FAMOUS A look at the money and glamour surrounding horses including an interview with Prince Charles on the celebrity sport of polo. (R)
 (6) JOHN ANKERBERG
 9:35 (4) DTV
 9:45 (4) NIGHT TRACKS In stereo.
 (SHOW) MOVIE ★★ "The Pope Of Greenwich Village" (1984, Drama) Eric Roberts, Mickey Rourke.
 10:00 (4) TAXI
 (5) TURKEY TELEVISION
 (6) (7) (8) (9) (10) (11) NEWS
 (12) MODERN MATURITY
 (13) NEWS / WEATHER / SPORTS
 (14) COUNTRY EXPRESS
 (15) (16) MOVIE ★★★ "Return Of A Man Called Horse" (1978, Adventure) Richard Harris, Gale Sondergaard.
 (17) FIGHTING FOR THE SOUL OF

AMERICA
 (18) MOVIE ★★ "Agent 83" (1985, Comedy) Dirk Bogarde, Sylvia Koscina.
 (19) GRAND OLE OPRY LIVE
 (20) V.J. JACKSON
 (21) ARCHIVES OF TIME
 (22) WRESTLING
 (23) CHRISTIAN CHILDREN'S FUND
 (24) MOVIE ★★ "A Run For Your Money" (1949, Comedy) Alec Guinness, Donald Houston.
 10:15 (4) (5) (11) ABC NEWS (4)
 10:30 (4) MOVIE ★★★ "The Boys From Brazil" (1978, Suspense) Gregory Peck, Laurence Olivier.
 (5) (6) AUSTIN CITY LIMITS John Anderson sings "Swingin'" and Lisa Glikson performs selections from a recent album. In stereo. (R)
 (7) EVANS & NOVAK
 (8) CAN YOU BE THINNER?
 (9) DAVID LETTERMAN SPECIAL "David Letterman's Holiday Film Festival" Bette Midler, Michael Keaton, Catherine O'Hara, Andrea Martin and Paul Shaffer's "Late Night" band are among guests presenting their own short-subject films. (R) In stereo.
 (10) NOVA An examination of the most recent developments in the study of communicating with animals. (R) (4)
 (11) POLICE STORY A lieutenant (Christopher George), anxious to solve a homicide, assigns 40 officers instead of the normal few to the investigation.
 (12) (13) SWITCH At a reunion of his old police buddies, Mac must discover or wrap of them to actually a killer.
 (14) WRAP AROUND NASHVILLE
 (15) MOVIE ★★ "Impasse" (1980, Adventure) Burt Reynolds, Anne Francis.
 (16) VALLEY OF ICE
 (17) EVERYBODY'S MONEY MATTERS
 HBO THE HITCHHIKER Susan Anspach stars in this thriller about a novelist who uses her hometown's most intriguing secrets in her books.
 10:35 (4) MOVIE ★★★ "Terror Out Of The Sky" (1978, Drama) Etem Zimballist Jr., Dan Haggerty.
 (5) MOVIE ★★ "The New Maverick" (1978, Western) James Garner, Charles Frank.
 (6) DEMPSEY & MAKEPEACE The robbers of Scottish bank notes plan to carry the cash out of the country, but if Dempsey (Michael Brandon) has his way their scheme won't work.
 10:40 (4) M*A*B'H
 10:45 (4) NIGHT TRACKS In stereo.
 (TMC) MOVIE ★★★ "Reuben, Reuben" (1983, Drama) Tom Conti, Kolly McGillis.

**FAST,
EXPERIENCED
VCR
SERVICE!**

Most Complete Shop In Town!

STORYLAND VIDEO
 278 Blue Lakes Blvd. N.
 734-5656

11:00 **1** **MISTER ED** "Ed's Diction Teacher" (1954, Comedy) Gene Hackman, Jim Brown.

2 **NEWS UPDATE / TRAVEL GUIDE**

3 **MOVIE** ★★½ "Riot" (1968, Drama) Gene Hackman, Jim Brown.

4 **JIMMY SWAGGART**

5 **MOVIE** ★★ "Silver Spurs" (1943, Western) Roy Rogers, Phyllis Brooks.

6 **ALFRED HITCHCOCK HOUR**

7 **BALLOONING IN EUROPE**

8 **HBO BOB DYLAN IN CONCERT** Taped in Sydney, Australia in February, 1966, this concert special features the veteran singer-songwriter on his True Confessions Tour. Backed by Tom Petty and the Meters, he performs songs from his live-recorded set "Biograph."

(SHOW) MOVIE ★★½ "Fletch" (1985, Comedy) Chevy Chase, Joe Don Baker.

CIN MOVIE ★★ "Perfect" (1985, Drama) John Travolta, Jamie Lee Curtis.

11:10 **10** **MOVIE** ★★½ "Duchess Of Idaho" (1940, Comedy) Eather Williams, Van Johnson.

11:30 **11** **DONNA REED** Jeff tries to stop a professor from retiring.

12 **INVESTIGATIVE REPORT**

(7) FRONTLINE The success or failure of affirmative action policies in Indianapolis and Memphis (Tenn.) are examined from a local perspective.

(9) IN SEARCH OF... "Indian Astronomers"

(12) (11) MTV TOP 20 VIDEO COUNT-DOWN

13 **U.S. HOUSE OF REPRESENTATIVES FLOOR DEBATE**

(12) MAKING MONEY WITH CARS

11:35 **14** **BEYOND TRON** William Katt takes a behind-the-scenes look at experimental projects at Lucas-film Ltd.

15 **DAVID LETTERMAN SPECIAL** "David Letterman's Holiday Film Festival" Bette Midler, Michael Keaton, Catherine O'Hara, Andrea Martin and Paul Shaffer's "Late Night" band are among guests presenting their own short-subject films. (R) in stereo.

11:45 **15** **NIGHT TRACKS** in stereo.

11:50 **SHOW MOVIE** "Nutcracker" (1984, Drama) Joan Collins, Carol White.

12:00 **16** **MOVIE** ★★½ "The Big Trees" (1952, Western) Kirk Douglas, Eve Miller.

17 **CROSSFIRE**

18 **MAD MOVIES WITH THE L.A. CONNECTION** Danny Kaye's character in the 1949 film "The Inspector General" is transformed into a rock singer in military garb.

(12) MOVIE ★★½ "Darker Than Amber" (1970, Mystery) Rod Taylor, Suzi Kendall.

19 **TALES FROM THE DARKSIDE** For a college student (Begonia Plaza) heading home for the holidays, a round-trip train ticket turns into a one-way trip of terror. (R)

20 **JEWISH VOICE BROADCAST**

(7) NIGHT FLIGHT "I Was A Zombie For The F.B.I." Mayhem erupts when aliens tamper with the recipe for the world's favorite soft drink. Directed by Marius Penczner.

(8) ANIMALS OF THE GREAT NORTHWEST

(9) SPEEDWEEK A peeky report on auto racing.

21 **BEST OF MONEY, MONEY**

22 **MOVIE** ★★ "Kid Millions" (1935, Comedy) Eddie Cantor, Ethel Merciman.

HBO MOVIE ★★½ "Fletch" (1985, Comedy) Chevy Chase, Joe Don Baker.

12:30 **23** **SPORTS LATENIGHT**

(3) FTV

11 **HERITAGE SINGERS**

12 **CHURCH STREET STATION**

(2) ENTERTAINMENT THIS WEEK An interview with Bruce Boxleitner.

13 **WILDLIFE CINEMA**

14 **SPORTSCENTER**

(18) 60 MINUTES TO SUCCESS

12:35 **24** **MTV TOP 20 VIDEO COUNT-DOWN**

15 **JOE** ★★ "Brother, Can You Spare A Dime?" (1975, Documentary) Directed by Philippe Mora.

12:45 **25** **NIGHT TRACKS** in stereo.

(SHOW) MOVIE ★★½ "The Pope Of Greenwich Village" (1984, Drama) Eric Roberts, Mickey Rourke.

1:00 **26** **NEWS / WEATHER / SPORTS**

(7) INDEPENDENT NEWS

(1) 700 CLUB

12 **SUCCESS-STRATEGIES FOR WOMEN**

(1) VJ: J.J. JACKSON

(12) AUTO RACING Formula One Canadian Grand Prix, from Circuit Gilles Villeneuve on Ile de Notre Dame in Montreal. (R)

(TMC) MOVIE ★★ "Rhinestone" (1984, Comedy) Sylvester Stallone, Dolly Parton.

1:05 **27** **TALES FROM THE DARKSIDE** A literary agent (Charles Knapp) hands a gifted writer (Larry Manetti) a bizarre formula for success. (R)

CIN MOVIE ★★ "Too Scared To Scream" (1985, Drama) Mike Connors, Anne Archer.

1:30 **28** **THIS WEEK IN JAPAN**

(7) MOVIE ★★½ "The Glass Key" (1942, Mystery) Alan Ladd, Veronica Lake.

(12) FAMILY GUIDE PRESENTS

1:35 **(2) MOVIE** ★★½ "The Mercutio-Nelson Murders" (1973, Mystery) Tolly Savalas, Marjoe Gortner.

(7) IN SEARCH OF... "MIAs"

1:40 **SHOW SOMETIMES I WONDER** After their mother brings home a new baby, their children feel they're unloved nuisances and escape to their grandmother's (Colleen Dewhurst) home.

1:45 **29** **NIGHT TRACKS** in stereo.

HBO MOVIE ★★ "Weekend Pass" (1984, Comedy) D.W. Brown, Peter Ellenstein.

2:00 **30** **TURKEY TELEVISION**

(7) LARRY KING WEEKEND

(12) WIN AT BLACKJACK

(12) NIGHT FLIGHT "Take Off"

(11) VJ: NINA BLACKWOOD

(19) VICTORY OVER IRS

2:30 **31** **700 CLUB**

15 **U.S. HOUSE OF REPRESENTATIVES FLOOR DEBATE**

2:40 **SHOW ROOM TO MOVE** Terence Donovan and Nicole Kidman star in this story of a young track star who realizes that being content with oneself is more important than being number one.

2:45 **32** **NIGHT TRACKS** in stereo.

2:50 **(SHOW) MOVIE** "Nutcracker" (1984, Drama) Joan Collins, Carol White.

CIN MOVIE ★★½ "Love Letters" (1983, Drama) Jamie Lee Curtis,

James Keach.

3:00 **33** **ROUTE 66**

11 **SPORTS REVIEW**

12 **TOM HOPKINS ON SELLING**

(12) NIGHT FLIGHT "Video Profile"

(11) VJ: NINA BLACKWOOD

13 **PGA SENIORS GOLF Tournament** Players Championship, second round, from Cleveland. (R)

(12) SUCCESS STRATEGIES FOR WOMEN

(TMC) MOVIE ★★½ "Cold Feet" (1983, Comedy) Griffin Dunno, Marias Chibas.

3:20 **HBO MOVIE** ★★ "Airplane!" (1980, Comedy) Robert Hays, Julie Hagerty.

3:30 **34** **MOONEYWEEK**

(7) MOVIE/NEWS

(12) NIGHT FLIGHT "Short Films"

3:35 **(2) NEWS**

3:45 **35** **NIGHT TRACKS** in stereo.

4:00 **36** **GOING GREAT**

(8) NEWS UPDATE / SHOWBIZ WEEK

(7) NEWS

(7) KEY TO SUCCESS

(12) NEWSIGHT '86

(12) GET RICH WITH FORECLOSURE

(12) NIGHT FLIGHT "I Was A Zombie For The F.B.I." Mayhem erupts when aliens tamper with the recipe for the world's favorite soft drink. Directed by Marius Penczner.

(8) INVESTMENT ADVISORY SHOW CAROLINE A determined girl tries to deal with her grandfather's prejudice as she sets out to win his love.

Curtis Mathes
HOME ENTERTAINMENT CENTER

SHOWSTOPPER MOVIE CLUB

CHOOSE FROM OVER
1300 MOVIES
MONDAY THRU THURSDAY

98¢ WITH MEMBERSHIP

VCR \$1.98 ANY DAY
JOIN TODAY!

RENT TO OWN

- No Down Payment
- No Credit Needed
- No Long-term Obligation
- 4-Year Curtis Mathes Warranty
- VCR's • Console TV's • Portable TV's

Curtis Mathes
HOME ENTERTAINMENT CENTERS
1024 Blue Lakes Blvd., March

FOUR YEAR WARRANTY

2 Sunday programs

MORNING

- 5:00 **POWERHOUSE**
1 NEWS / WEATHER / SPORTS
2 IT IS WRITTEN
3 GREATEST SPORTS LEGENDS
4 JIMMY SWAGGART
5 60 MINUTES TO SUCCESS
6 SPEEDWEEK
7 FREDERICK K. PRICE
 5:30 **KIDS WRITES**
1 WORLD VISION
2 BIG STORY
3 BUGS BUNNY AND FRIENDS
4 THREE SCORE / COMMUNITY CALENDAR
5 U.S. HOUSE OF REPRESENTATIVES FLOOR DEBATE
6 SPORTSCENTER
 SHOW THE WONDERFUL WORLD OF THE WOMBLES Animated. Fat and fuzzy creatures, the Wombles, want a clean world and embark on a mission to teach humans how to pick up after themselves.
 5:40 (SHOW) **ROOM TO MOVE** Terence Donovan and Nicole Kidman star in this story of a young track star who realizes that being content with oneself is more important than being number one.
 5:45 **WHAT'S NU?**
CIN MOVIE ★★ "The Buddy Holly Story" (1978, Biography) Gary Busby, Don Stroud
 6:00 **OUT OF CONTROL**
1 NEWS / WEATHER / SPORTS
2 JAMES KENNEDY
3 A MILLIONAIRE'S SECRET TO WEALTH
4 NIGHT FLIGHT
5 SCIENCE IN AGRICULTURE
6 VJ: ALAN HUNTER
7 FISHING THE WEST
8 FISHING: JOHN FOX'S OUTDOOR ADVENTURES
9 KENNETH COPELAND
10 MOVIE ★★ "A Run For Your Money" (1949, Comedy) Alec Guinness, Donald Houston
 6:20 HBO **BOB DYLAN IN CONCERT**

- Inoped in Sydney, Australia in February 1986, this concert special features the veteran singer-songwriter on his True Confessions Tour. Backed by Tom Petty and the Heartbreakers, he performs songs from his five-record set "Biograph."
 6:30 **BELLE AND SEBASTIAN**
1 MUPPETS
2 HISPANIC REVIEW
3 CROSSFIRE
4 AGRICULTURE U.S.A.
5 BUGS BUNNY AND FRIENDS
6 (12) JIM AND TAMMY
7 ROBERT SCHULLER □
8 (11) U.S. FARM REPORT
9 USU AND YOU
10 LORNE GREENE'S NEW WILDERNESS
11 FLY FISHING WITH JOE HUMPHREYS
(TMC) MOVIE ★★ "F.I.S.T." (1978, Drama) Sylvester Stallone, Peter Boyle.
 7:00 **IT IS WRITTEN**
1 LITTLE PRINCE
2 (11) TO BE ANNOUNCED
3 BUGS BUNNY BUDDIES
4 DAYWATCH
5 JAMES KENNEDY
6 NEWS
7 SESAME STREET (R) □
8 SUNDAY MASS
9 KENNETH COPELAND
10 DONALD DUCK PRESENTS
11 COUNTRY SPORTSMAN Roger Miller goes fishing for catfish on the Mississippi River near Helena, Miss. In stereo.
12 NIGHT FLIGHT
13 SACRED HEART
14 WORLD VIEW
15 FACES
16 VIEWER CALL-IN
17 FISHIN' HOLE
18 CAN YOU BE THINNER?
 (SHOW) **CAROLINE** A determined girl tries to deal with her grandfather's prejudice as she sets out to win his love.
 SHOW FAERIE TALE THEATRE "The

- Emperor's New Clothes" Art Carney and Alan Arkin play two con men who manage to make the emperor (Dick Shawn) believe he's wearing a nonexistent suit of clothes. In stereo.
 □
 7:15 **FROM THE CATHEDRAL**
 7:30 **DAY OF DISCOVERY**
1 MR. WIZARD'S WORLD
2 YOUR MONEY
3 MUSIC AND THE SPOKEN WORD
4 NEWS
5 (12) JIMMY SWAGGART
6 CHICAGOLAND CHURCH
7 WISH UPON A STAR
8 BASSMASTERS
9 NIGHT FLIGHT
10 ROBERT SCHULLER □
11 WORLD TOMORROW
12 SUNDAY MORNING "Vladimir Horowitz in Moscow," a repeat of the renowned classical pianist's April 20 Moscow Conservatory concert. Charles Kuralt hosts. (R)
13 INVESTMENT ADVISORY
HBO MOVIE ★★ "Young And Free" (1979, Adventure) Erik Larson, Kelth Larzen.
 (SHOW) **THE HAUNTING OF HARRINGTON HOUSE** A schoolgirl returns home for a holiday to find strange things happening at her father's hotel.
 7:35 **ANDY GRIFFITH**
 8:00 **TO BE ANNOUNCED**
1 LASSIE
2 (7) (10) MISTER ROGERS (R)
3 NEWS UPDATE / ON THE MENU
4 JERRY FALWELL
5 HAPPY DAYS
6 JIMMY SWAGGART
7 BUGS BUNNY
8 LLOYD OGILVIE
9 MOUSERISE
10 AMERICAN SPORTS CAVALCADE
11 CARTOONS
12 LARRY JONES
13 CONGRESSIONAL HEARING
14 MAJOR LEAGUE BASEBALL'S GREATEST HITS '87 World Series. (Red Sox vs. Cardinals)
15 INVESTMENT ADVISORY
16 MOVIE ★★ "Kid Millions" (1935, Comedy) Eddie Cantor, Ethel Merman.
SHOW MOVIE ★★ "The Last Starfighter" (1984, Science Fiction) Lance Guest, Robert Preston.
CIN ROCK AND ROLL: THE EARLY DAYS The roots of rock 'n' roll are traced through the careers of Bill Haley, the Everly Brothers, Fats Domino, Buddy Holly, Bo Diddley, Elvia Presley and others.
 8:05 **GOOD NEWS**
 8:30 **TURKEY TELEVISION**
1 TABERNACLE CHOIR
2 (10) 3-2-1 CONTACT □
3 NEWSMAKER SUNDAY
4 STRICTLY BUSINESS
5 NEWTON'S APPLE
6 (12) 700 CLUB
7 JEM
8 (11) CHRISTIAN LIFESTYLE MAGAZINE
9 DAVEY AND GOLIATH
10 YOU AND ME, KID Guest: Jamie Lyn Bauer.
11 WORLD TOMORROW

Sports Highlights

- 11 a.m. (CBS) **AUTO RACING** The Detroit Grand Prix: live racing action from the motor city.
- 11:30 a.m. (ESPN) **PGA SENIORS GOLF** Final round action from the The Tournament Players Championship, live from Cleveland.
- 1:30 p.m. (CBS) **PGA GOLF** Final round action of the Atlanta Classic, live from Marietta, Ga.
- 2 p.m. (NBC) **DRAG RACING** NBC SportsWorld presents taped highlights of the NHRA world championships from Pomona, Calif.
- 4 p.m. (NASHVILLE) **RODEO** The Mesquite Championship Rodeo from Mesquite, Texas, broadcast in stereo.

② KENNETH COPELAND (SHOW) THE WONDERFUL WORLD OF THE WOMBLES Animated. Fat and fuzzy creatures, the Wombles, want a clean world and embark on a mission to teach humans how to pick up after themselves.

8:35 ⑦ MOVIE ★★ "Operation Petticoat" (1959, Comedy) Cary Grant, Tony Curtis.

9:00 ⑧ DANGER MOUSE

⑨ HERALD OF TRUTH

⑩ ⑪ SESAME STREET (R) □

⑫ NEWS UPDATE / TRAVEL GUIDE

⑬ ORAL ROBERTS

⑭ NEWS

⑮ DAY OF DISCOVERY

⑯ RAWHIDE

⑰ (11) ROBERT SCHULLER □

⑱ SUPERBOOK CLUB

⑲ DUMBO'S CIRCUS

⑳ KENNETH COPELAND

㉑ VJ: ALAN HUNTER

㉒ AMERICA'S CUP '87: BRING

BACK THE CUP

㉓ PHYSICIAN'S JOURNAL UPDATE

HBO FRAGGLE ROCK Junior Gorg sells the family mansion in return for the Peas of Power. □

(TMC) MOVIE ★★★ "Vision Quest" (1985, Drama) Matthew Modine, Linda Fiorentino.

CIN MOVIE ★★★ "Evil Under the Sun" (1982, Mystery) Peter Ustinov, Jane Birkin.

9:30 ② INTERACTION

③ STAR TREK

④ ⑤ (11) ORAL ROBERTS

⑥ JEM

⑦ SPORTSWEEK

⑧ KENNETH COPELAND

⑨ WALL STREET JOURNAL REPORT

⑩ NEWS

⑪ (12) ROBERT SCHULLER □

⑫ GOOD MORNING MICKEY!

⑬ WISH YOU WERE HERE

⑭ JERRY FALWELL

⑮ MORMON TABERNACLE CHOIR

HBO FRAGGLE ROCK Junior Gorg's

future hangs in the balance when

he's summoned to play the Royal Ka-

zoo. □

10:00 ① ② TO BE ANNOUNCED

③ YOU CAN'T DO THAT ON TELEVISION

④ ⑤ MISTER ROGERS (R)

⑥ MORE

⑦ NEWS / WEATHER / SPORTS

⑧ NEWS

⑨ NATURE

⑩ VIEWPOINT

⑪ WILD, WILD WEST

⑫ (11) MUSIC AND THE SPOKEN

WORD

⑬ SHARI LEWIS

⑭ WELCOME TO POOH CORNER

⑮ PERFORMANCE PLUS

⑯ DAY OF DISCOVERY

⑰ WORLD TOMORROW

⑱ NATIONAL PRESS CLUB

⑲ NFL FILMS PRESENTS Profiled:

Lou Saban, former coach.

⑳ ANNA OF THE FIVE TOWNS Corruption and greed abound in this tale of the 19th-century world of Britain's pottery industry. (Part 1 of 4)

HBO MOVIE ★★★ "My Science Project" (1985, Comedy) John Stockwell, Danna Hopper.

(SHOW) FAERIE TALE THEATRE

"The Emperor's New Clothes" Art Carney and Alan Arkin play two con men who manage to make the emper-

or (Dick Shawn) believe he's wear-

a nonexistent suit of clothes. In stereo. □

SHOW PAPER CHASE Rose (Lainie Kazan) becomes dissatisfied with her divorce lawyer and decides to handle the proceedings herself.

10:30 ② FOR OUR TIMES Islamic experts voice their concern over the use of the term Jihad, or Holy Wars, by Western journalists.

③ NICK ROCKS: VIDEO TO GO

④ INSIGHT

⑤ ⑥ 3-2-1 CONTACT □

⑦ ⑧ THIS WEEK WITH DAVID BRINKLEY □

⑨ INVESTIGATIVE REPORT

⑩ WORLD TOMORROW

⑪ ⑫ MEET THE PRESS

⑬ (12) LARRY JONES

⑭ (11) TO BE ANNOUNCED

① FLIPPER

② DONALD DUCK PRESENTS

③ HIDDEN HEROES

④ IT IS WRITTEN

⑤ EXCITING WORLD OF SPEED

AND BEAUTY

⑥ OBSTETRICS / GYNECOLOGY

UPDATE

11:00 ⑦ ⑧ ⑨ ⑩ (11) AUTO RACING

Detroit Grand Prix (Live)

⑪ ⑫ FUNNY BUSINESS: THE ART

OF CARTOONING

⑬ NEWS / WEATHER / SPORTS

⑭ ⑮ THIS WEEK WITH DAVID

BRINKLEY □

⑯ ⑰ ⑱ WIMBLEDON: THE 100TH

FLEX-A-BED

More than
a bed...

much
more
than
a chair!

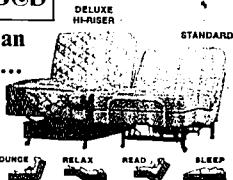

Sizes & styles available to fit your pocket book...

LIFT SEAT



Adjust
electrically
to hundreds
of restful
positions

BOTH BEDS & CHAIRS ARE ELEC. POWERED

Provides Mobility,
Comfort & Luxury
During your "Sleeping
& Waking Hours."
Sold Nation Wide By Authorized
Dealers & Sales Organizations
For Over 15 Years.



RECLINE

Come in for a free demonstration today...

- Liberal Trades
- Revolving Charge Plan
- Free Parking While Shopping
- Our 2 Stores
- Open Fridays - til 7

733-7111



204 Main Ave. N.

Sunday

EDITION A preview of this year's 100th anniversary of the Wimbledon Tennis classic.

7 MOVIE ★★ "Somebody Up There Likes Me" (1950, Biography) Paul Newman, Pier Angeli.

8 WORLD OF AUDUBON The breeding, births, behavior and diseases of the elusive black-footed ferret.

9 (12) CANYON FORUM

10 ONE STEP BEYOND

11 GENTLE BEN

12 WIND IN THE WILLOWS

13 RODEO Mesquite Championship Rodeo from Mesquite, Texas. In stereo.

14 VJ: MARTHA QUINN

15 WEEK'S HEADLINES

16 NFL SUPERSTARS Profiled: Bud Grant and Vince Lombardi.

17 AMA VIDEO CLINIC Topic: Obesity and overweight.

18 STAGE: LAST DAY Docudrama encompassing the last days of the American Embassy in Saigon and the steady decline of American political strength in Southeast Asia.

(SHOW) MOVIE ★★ "The Last Starfighter" (1984, Science Fiction) Lance Guest, Robert Preston.

SHOW MOVIE ★★ "Kind Lady" (1951, Suspense) Ethel Barrymore, Maurice Evans.

(TMC) MOVIE ★ "Escape From El Diablo" (1983, Adventure) Jimmy McNichol, Timothy Van Patten.

CIN MOVIE ★★ "It Started With A Kiss" (1959, Comedy) Glenn Ford, Debbie Reynolds.

11:20 (2) SUPERTED

11:30 (3) LASSIE

12 INNOVATION

13 WALTONS

14 MONEYWEEK

15 (12) CAN YOU BE THINNER?

16 BASEBALL Chicago Cubs at New York Mets (Live)

17 KIDS INCORPORATED

18 MOVIE ★★ "The Parent Trap" (1981, Comedy) Hayley Mills, Maureen O'Hara.

19 PGA SENIORS GOLF Tournament Playoffs Championship, final round, live from Cleveland.

11:55 (3) (8) (17) WORLD CUP SOCCER



3:05 p.m. (WTBS) War of the Worlds Hold on to your light sabers: this is one of the classic science-fiction films of all time. H.G. Wells provided the plot for this impressive and frightening story about Armageddon, in the form of an invasion by hostile, technically-superior Martians. A sound script and Oscar-winning special effects make this 1953 effort a great nostalgia trip.

Quarterfinal Match live from Mexico City.

AFTERNOON

12:00 (3) THE TAP DANCE KID A young boy whose first love is dancing is offered a chance by his uncle to audition for a role in summer stock.

(4) (10) WILD GAME AND COUNTRY COOKING

5 WEEK IN REVIEW

6 NEWS

7 BASEBALL Atlanta Braves at Cincinnati Reds (Live)

8 (12) MOVIE ★★½ "The War Between Men And Women" (1972, Comedy) Jack Lemmon, Barbara Harris.

9 MOVIE ★★ "The Tall Stranger" (1957, Western) Joel McCrea, Virginia Mayo.

10 COUNTRY SPORTSMAN Roger Miller goes fishing for catfish on the Mississippi River near Helena, Miss. In stereo.

11 STAR GAMES Sports competition featuring cast members from "Falcon Crest," "Days of Our Lives" and "General Hospital." Final round. (R)

12 CONGRESSIONAL HEARINGS, PUBLIC POLICY ADDRESS, PRESS CONFERENCE

13 CARDIOLOGY UPDATE

HBO MOVIE ★★ "The Muppets Take Manhattan" (1984, Comedy) Voices of Jim Henson, Frank Oz.

12:25 (2) STAGE: WORLD WALK The outling is Spandau prison, where Nazi war criminal Albert Speer, while outcast by his fellow prisoners, composes his memoirs. Stars Alec McCowen and Ralph Neasek.

12:30 (4) (10) MAGIC OF OIL PAINTING

13 TO BE ANNOUNCED

14 WORLD OF PHOTOGRAPHY

15 BASSMASTERS

SHOW MOVIE ★★ "Gremlins" (1984, Fantasy) Zach Galligan, Hoyt Axton.

(TMC) MOVIE ★★ "The Return Of Martin Guerre" (1981, Drama) Gerard Depardieu, Nathalie Baye.

1:00 (4) THE INCREDIBLE BOOK ESCAPE The voices of Ruth Buzzi, George Gobel, Tammy Grimes and Arte Johnson are featured in this special which combines live action and animation in the story of a girl (Quinn Cummings) who meets a host of literary characters after hours in a library.

(4) (10) GREAT OUTDOORS Jim Tabor demonstrates hang gliding in Kitty Hawk, N.C., and visits a wildlife preserve near Boston. (R) □

(4) (8) BASEBALL

16 LARRY KING WEEKEND

17 MYSTERY! "Agatha Christie's Partners in Crime" Tommy and Tuppence Beresford investigate the murder of a masked woman during a lover rendezvous at a nightclub. (R) □

18 AMERICAN SPORTS CALVADE

19 WRESTLING

20 HAWKIN'S RIVER

(SHOW) PHYSICIAN'S JOURNAL UPDATE (SHOW) PAPER CHASE Rose (Lainie Kazan) becomes dissatisfied with her divorce lawyer and decides to handle the proceedings herself.

CIN MOVIE ★★ "Grease" (1978, Musical) John Travolta, Olivia Newton-John.

1:30 (3) (7) (11) PGA GOLF AI-

lanis Classic, final round, live from Marietta, Ga.

(4) (10) IMAGES IN WATERCOLOR

11 WAGON TRAIN A captain's (Ronald Reagan) lonely and temperamental wife (Ann Blyth) is asked to leave the quiet atmosphere of the Army post.

12 AUTO RACING IMSA Camel Grand Prix, from West Palm Beach, Fla. (Taped)

13 SOAPS, LUCY, THE HILL AND YOU Experts at the 5th International Conference of Television Drama reveal their views on television programming.

1:35 (4) MOUSE FACTORY

2:00 (2) STANDBY... LIGHTS! CAMERA! ACTION!

(4) (10) BROWN SUGAR Lena Horne, jazz pianist Hazel Scott, dancer-choreographer Katherine Dunham, Eartha Kitt, singer Joyce Bryant and Dorothy Dandridge are profiled. □

3 NEWS UPDATE / SCIENCE - TECHNOLOGY WEEK

4 (8) (17) SPORTSWORLD Scheduled: Azumah Nelson (23-1, 17 KO's) vs. Juan LaPorte (26-6, 13 KO's) for the WBC Featherweight title, scheduled for 12 rounds, live from San Juan, P.R.; NHRA World Finals of Drag Racing, featuring Pro Stocks and Funny Cars, from Pomona, Calif. (Taped)

5 MASTERPIECE THEATRE "The Irish R.M." A drunken "mountain" man demands compensation after a Christmas Eve collision with the Yeates' carriage. (Part 4 of 6) □

(4) (12) MOVIE ★★ "Station Road" (1947, Drama) Ronald Reagan, Alexis Smith.

6 RETURN TO TREASURE ISLAND "Treasure Island" Long John Silver rescues Jim from Garcia and they set sail with Van Der Brecken for Treasure Island.

7 MOVIE ★½ "Little Mad Guy" (1980, Adventure) Yuan Siu Tin, Ng Ming Teai.

8 VJ: MARTHA QUINN

9 ASIAN INSIGHTS

10 DUTCH NATIONAL BALLET Hans van Manen directs performances of "Plane Variations" and "Grosse Fuge" and speaks of his work with the company.

HBO MOVIE ★★ "A Rare Breed" (1982, Drama) George Kennedy, Forrest Tucker.

(SHOW) MOVIE ★★½ "Kind Lady" (1951, Suspense) Ethel Barrymore, Maurice Evans.

2:30 (3) EVANS & NOVAK

11 MOVIE ★★ "The Longest Day" (1962, Drama) John Wayne, Robert Mitchum.

12 WISH YOU WERE HERE Featured: Death Valley, Calif. In stereo.

13 SURGERY UPDATE

SHOW HONEYMOONERS: THE LOST EPISODES While their apartment is being painted the Normans move in with the Kramdens; Ralph has trouble getting through a rehearsal of a speech he is giving at the Raccoon Lodge without being interrupted. □

(TMC) MOVIE ★★½ "F.I.S.T." (1978, Drama) Sylvester Stallone, Peter Boyle.

3:00 (3) ROUTE 66 "Tod's aunt" (Beatrice Straight) asks Tod and Buz to find her missing daughter in a Los Angeles slum.

- (8) COOKING CHEAP**
(9) NEWS / WEATHER / SPORTS
(7) CLASSIC COUNTRY
(1) MOVIE ★★ "Song Of Arizona" (1948, Western) Roy Rogers, George "Gabby" Hayes.
(13) THE GOLD BUG A young boy becomes involved in a suspenseful hunt for Captain Kidd's buried treasure.
(2) PERFORMANCE PLUS
(6) CHRONICLE
(9) CAMPAIGN '86
(14) POSTMENOPAUSAL OSTEOPO- ROSIS A look at the prevention and treatment of postmenopausal osteoporosis.
SHOW MOVIE ★★★ "The In-Laws" (1979, Comedy) Alan Arkin, Peter Falk.
CIN BRITISH ROCK: THE FIRST WAVE A montage of clips of the Beatles, The Rolling Stones, The Kinks and The Who highlight this look at the British rock invasion of the mid-60's.

3:30 (2) MOVIE ★★★ "The War Of The Worlds" (1953, Science-Fiction) Gene Barry, Ann Robinson.

3:30 (2) (1) FRUGAL GOURMET Jeff Smith cooks stuffed onion leaves and onions sauteed with peppers Italian style.

(1) NEWSMAKER SUNDAY
(13) HEROES
(14) OC'S MINIMIZING METABOLIC RISKS

HBO LINDA RONSTADT WITH THE NELSON RIDDLE ORCHESTRA Selections include "What's New," "I've Got A Crush On You" and "Crazy He Calls Me."

(SHOW) MOVIE ★★★ "Goblins" (1984, Fantasy) Zach Galligan, Hoyt Axton.

4:00 (2) (1) (1) LORNE GREENE'S NEW WILDERNESS

(1) ISPY
(1) FISHING THE WEST
(13) VICTORY GARDEN A visit to garden writer Mary Ellen Guffey's Malibu (Calif.) home.
(1) WONDER WOMAN

(2) NEWS / WEATHER / SPORTS
(2) BOB NEWHART Bob's therapy group has an unexpected visitor when a friendly homosexual joins the session.

(2) MUPPETS Guest: Lesley Ann Warren.

(7) BODYWATCH The mind's link to the immune system; cancer patients' use of visualization techniques; Tibetan monks' ability to control body temperature. Guest: Norman Cousins. (R) □

(1) JEFFERSONS A challenge to a boxing match humbles George's big mouth and matching ego. □

(2) (12) MOVIE ★★½ "Reunion At Fairborough" (1985, Drama) Robert Mitchum, Deborah Kerr.

(1) ALLAN SMITH AND JONES A young woman (Diana Hyland) who has chosen an outlaw as her murder target lures Hayes to his old gang's hideaway.

(13) MUSIC FOR EVERYBODY Nelson Eddy, Dinah Shore and Benny Goodman join maestro Ludwig von Drake in this animated musical variety show.

(13) RODEO Mesquite Championship Rodeo from Mesquite, Texas. In stereo.

(6) MOVIE ★★ "Imprper Channels"

(1981, Comedy) Alan Arkin, Mariette Hartley.

(7) CHECK IT OUT! Edna's implementation of a Japanese management technique causes disorientation for Howard and the staff. (R)

(1) VJ: MARK GOODMAN

(13) MOVIE ★★ "Battle For The Planet Of The Apes" (1973, Science-Fiction) Roddy McDowall, Claude Akins.

(2) TALENT SHOWCASE

(2) CHRONICLE

(12) VIEWER CALL-IN

(13) NEPHROLOGISTS Renal physiology, effects of stress on the kidneys, disease and immune aspects of glomerular disease are covered.

(13) CLAUDE BOLLING CONCERTO Pianist George Shearing and guitarist Angel Romero perform Bolling's concerto for classical guitar and jazz piano.

CIN MOVIE ★★½ "Pygmalion" (1938, Comedy) Leslie Howard, Wendy Hiller.

4:30 (2) WILD KINGDOM

(1) (2) (1) (1) CBS NEWS

(1) (1) THE OLD HOUSE Building shelves and cabinets; hanging a door. □

(1) ABC NEWS □

(1) INSIDE BUSINESS

(1) CAN YOU BE THINNER?

(7) VIEWPOINT

(7) WALL STREET WEEK "Stockman on Reagan" Guest: former Budget Director David Stockman.

(1) (7) NBC NEWS

(1) FISHING: MARK SOSIN'S SALT WATER JOURNAL

HBO MOVIE ★★½ "Norma Rae" (1979, Drama) Sally Field, Beau Bridges.

5:00 (2) CBS NEWS

(1) SMOTHERS BROTHERS

(1) HEE HAW Guests: Louise Mandrell, Del Reeves, Danny Darst. (R)

(1) (1) WALL STREET WEEK "Stockman on Reagan" Guest: former Budget Director David Stockman.

(1) SPORTS SUNDAY

(1) THAT'S INCREDIBLE!

(2) NEWS

(7) ADAM SMITH'S MONEY WORLD

(1) BUCK ROGERS The Searcher discovers a derelict spaceship whose cargo is about to explode.

(7) (11) SOLID GOLD Scheduled: Stevie Wonder (co-host), Laura Branigan, Thompson Twins, Michael McDonald, Charlie Daniels Band, New Edition, Duran Duran (interview). In stereo. (R)

(1) DORIS DAY'S BEST FRIENDS Guest: Gretchen Wyler.

(1) MOVIE ★★½ "Hog Wild" (1974, Drama) John Ericson, Denver Pyle.

(1) BASSMASTERS

(7) BOSOM BUDDIES Kip, Sonny, Henry and Amy Imagine what their lives will be like as senior citizens.

(2) M*A*S*H

(2) AUSTRALIAN ARK

(2) INTERVIEW

(1) SPORTSCENTER

(14) STRUCTURAL CONSIDERATIONS OF ANTIBIOTICS

(13) GREAT DETECTIVE "It Looks Could Kill" Sergeant Stryker falls under the spell of a dubious hypnotist.

SHOW FAERIE TALE THEATRE "The Emperor's New Clothes" Art Carney and Alan Arkin play two con men who manage to make the emperor (Dick Shawn) believe he's wearing a

nonexistent suit of clothes. In stereo.

□

(TMC) MOVIE ★★★ "Royal Wed- ding" (1951, Musical) Fred Astaire, Jane Powell.

5:00 (1) WRESTLING

6:30 (2) (7) (2) NEWS

(1) DONNA REED Donna secretly writes about the Stone family.

(1) (1) ADAM SMITH'S MONEY WORLD

(1) JEFFERSONS

(2) TWILIGHT ZONE A folk singer goes into the backwoods to find a song that will bring him commercial success.

(2) NBC NEWS

(7) NEWTON'S APPLE Facial reconstruction techniques reveal what "Dead Earnest" looked like; why rainbows are curved; how popcorn pops; bathing a baby hippo. □

(1) MOVIE ★★½ "A Ticket To To- mshawk" (1950, Western) Dan Da- ley, Ann Baxter.

(1) FLIPPER

(1) WISH YOU WERE HERE Featured: Death Valley, Calif. In stereo.

(1) OBSTETRICS / GYNECOLOGY UPDATE

(SHOW) HONEYMOONERS: THE LOST EPISODES While their apart- ment is being painted the Nortona move in with the Kramdens; Reip has trouble getting through a re- hearsal of a speech he is giving at the Raccoon Lodge without being in- terrupted. □

EVENING

6:00 (2) (1) (2) (1) (1) 60 MINUTES

(2) MY THREE SONS

(1) (1) NOVA An examination of the most recent developments in the study of communicating with animals. (R) □

(1) (1) (1) (1) DISNEY SUMMER CLAS- SICS "Herbie Rides Again" The lov- able Volkswagon with a mind of its own aids a San Francisco grand- mother battling an evil businessman. Helen Hayes and Ken Berry star in this 1974 film. □

(2) NEWS / WEATHER / SPORTS

(7) COUSTEAU'S REDISCOVERY OF THE WORLD Jacques Cousteau and his crew explore economically strapped Haiti, a country threatened by poor ecological management and rapid population growth.

(7) RUSH

(1) (7) SILVER SPOONS In stereo.

**BAND
 INSTRUMENT
 RENTALS
 NOW AVAILABLE
 FOR SUMMER BAND!**

WELCH MUSIC
 1036 Blue Lakes North
 Twin Falls, Idaho

12 (12) FANTASTIC WORLD OF HANNA-BARBERA

11 JOURNEY THROUGH THE FIRST YEAR OF LIFE American Baby Magazine editor Judith Nofte and educational psychologist Dr. Burton L. White host this documentary on infant development featuring infants' developmental milestones, the meaning of each stage and how parents can enhance growth patterns. Also, a contest for a \$25,000 college scholarship and other prizes.

10 AMERICAN SPORTS CAVALCADE

9 ALFRED HITCHCOCK HOUR

8 TOWARDS 2000

7 WEEK AHEAD

6 NFL FILMS PRESENTS New York Giants Championship Year.

5 PHYSICIAN'S JOURNAL UPDATE

4 BUFFALO BILL Jo Jo faces the prospect of single parenthood when Bill won't make an honest woman out of her.

(SHOW) MOVIE ★★★ "The In-Laws" (1979, Comedy) Alan Arkin, Peter Falk.

SHOW MOVIE ★★★ "Explorers" (1985, Science Fiction) Ethan Hawke, River Phoenix.

CIN MOVIE ★★★ "Irreconcilable Differences" (1984, Comedy) Ryan O'Neal, Shelley Long.

0.05 NATIONAL GEOGRAPHIC EXPLORER A Zimbabwe safari; the Chinese city of Suzhou; high-tech camera inventor Garrett Brown; the Sydney to Hobart Yacht Race.

0.30 7 MISTER ED "Ed, The Godfather"

(8) 6 PUNKY BREWSTER A mentally handicapped custodian (Bonnie Urseth) has a special talent as a musician in stereo. (R) 1

5 Q.E.D.

4 NFL'S GREATEST MOMENTS Legends of the Fall.

3 RISING DAMP "Under The Influence" Rigsby is hypnotized into making love with Ruth.

2 HBO THE BERENSTAIN BEARS PLAY BALL Animated. Papa Bear's ambitions for his children in Little League result in a surprise and an important lesson. (I)

6.35 10 MOUSETEPIECE THEATER

7:00 2 (3) (2) (1) MURDER, SHE



8 p.m. (KTRV) Sunset Boulevard Director Billy Wilder brought an artistic approach to this 1950 comedy-tragedy about a faded silent film idol (Gloria Swanson) and the young hack screen writer she shelters (William Holden). Swanson's semi-autobiographical performance is quirky and fascinating. Look for brief appearances by Hollywood greats Buster Keaton and Cecil B. DeMille.



Dinah Manoff stars as the estranged daughter of a washed-up Hollywood writer whom she surprises with a visit after a 16-year separation in Neil Simon's I OUGHT TO BE IN PICTURES on 'The CBS Sunday Night Movies,' Sunday at 8 p.m. on KBCI-Boise, KID-Idaho Falls, KMVT-Twin Falls and KSL-Salt Lake City.

WROTE Jessica investigates a murder while on an archaeological dig in New Mexico. Guests include Robert Vaughn, Randolph Mantooth and Connie Stevens. (R) 1

2 MOVIE ★★★ "The Divorce of Lady X" (1938, Comedy) Merle Oberon, Laurence Olivier.

1 (10) HEART OF THE DRAGON An exploration of contemporary Chinese art, featuring painters Huang Yung Yu and Lo Zhongli and footage of rural China. (R) 1

7 WEEK IN REVIEW

2 (8) AMAZING STORIES A notorious magician (Sid Caesar) considers retirement until he finds a charmed deck of cards. In stereo. (R) 1

1 (7) NATURE The effects of the Iranian-Iraqi war on wildlife in the Arabian Gulf. (R) 1

11 IN TOUCH

10 ANIMALS IN ACTION "Tails" This episode offers a look at some animals and their tails.

9 MONROES

8 LAST STAND OF THE TARUMARAS

7 V.J. MARK GOODMAN

6 PERSPECTIVE

5 MAJOR LEAGUE BASEBALL'S GREATEST HITS '75 World Series. (Red Sox vs. Reds).

4 (10) INSIDE THE THIRD REICH Albert Speer ignores the pleas of his family and assumes the responsibility for Hitler's war machine, though he does defy Hitler's last order to level all of Germany. (Part 2 of 2)

100 MOVIE ★★★ "My Science Project" (1985, Comedy) John Stockwell, Dennis Hopper.

(TMC) MOVIE ★★★ "Visions Quest" (1985, Drama) Matthew Modine, Linda Fiorentino.

7:30 7 (3) ALFRED HITCHCOCK PRESENTS A young social outcast takes her own attack to gain media attention. In stereo. (R) 1

6 (12) SUPER SUNDAY

5 (9) ODD COUPLE Felix is incensed when Oscar gives a riotous account of his marriage on a talk show.

4 DANGER BAY Nicole and a group of younger campers encounter a case of botulism while on a wilderness survival trip.

3 PERFORMANCE PLUS

2 MOVIE ★★ "The Vegas Strip War" (1984, Drama) Rock Hudson, James Earl Jones.

10 LIVING TOMORROW

9 CONGRESSIONAL HEARINGS, PUBLIC POLICY ADDRESS, PRESS CONFERENCE

8 INTERNAL MEDICINE UPDATE

6 00 3 (7) (6) (11) MOVIE ★★ "I Ought To Be In Pictures" (1982, Comedy) Walter Matthau, Ann-Margret.

5 (10) NATURE The effects of the Iranian-Iraqi war on wildlife in the Arabian Gulf. (R) 1

4 (4) (6) MOVIE ★★★ "The Final Countdown" (1980, Science-Fiction) Kirk Douglas, Martin Sheen.

3 NEWS / WEATHER / SPORTS

2 (8) MOVIE ★★ "The Vegas Strip War" (1984; Drama) Rock Hudson.

| | 7:00 | 7:30 | 8:00 | 8:30 | 9:00 | 9:30 | 10:00 | 10:30 | 11:00 | 11:30 | 12:00 | 12:30 |
|------|-----------------------------|---------------------|------------------------------------|---------------------|-------------------------------|------|---------------------------|------------|------------|-------------------------------|------------------------|---------|
| 2 | Murder, She Wrote | | Movie: "I Ought To Be In Pictures" | | | | Taxi | All Family | News | Interactio. | | |
| 6 | Heart Of The Dragon | Nature | | Masterpiece Theatre | | | Computer | McLaughl. | | | | |
| 9 | Disney Cont'd | | Movie: "The Final Countdown" | | | | News | Rally | Twil. Zone | Hawaii Five-0 | | Mock |
| 7 | Amazing | Hitchcock | Movie: "The Vegas Strip War" | | | | News | M*A*S*H | Alice | Liverna | Rep. Days | News |
| 7 | Fantastic | Cartoon | Movie: "Sunset Boulevard" | | | | WKRP | Jeffersons | C. Burnett | Forum | | |
| 12 | Murder, She Wrote | | Movie: "I Ought To Be In Pictures" | | | | News | | | Movie: "A Ticket To Tomahawk" | | |
| SHOW | Movie Cont'd | Faerie Tale Theatre | | Movie: "Explorers" | | | | | Brothers | Bizarre | Honeymn. | Movie |
| SHOW | Movie Cont'd | Brothers | Bizarre | Honeymn. | Movie: "The Last Starfighter" | | | | | | Movie: "Mike's Murder" | |
| HBO | Movie: "My Science Project" | | | Philip Marlowe | | | Movie: "A View To A Kill" | | | | | Replata |

James Earl Jones.

7) GREAT RAILWAY JOURNEYS OF THE WORLD. Michael Frayn takes a journey across Australia.

8) (12) MOVIE ★★ ★ "Sunset Boulevard" (1950, Drama) William Holden, Gloria Swanson.

9) NEWS

10) BEN HADEN

11) MOVIE ★★ ★ "Paris Holiday" (1950, Comedy) Bob Hope, Fernand.

12) HIDDEN HEROES

13) THE VIRGINIAN

14) ROCK INFLUENCES Featured: Stevie Ray Vaughan discusses the Texas influence on rock 'n' roll.

15) MISSING IN ACTION

16) AMERICA'S CUP: AUSTRALIA IN THE SPIRIT REBORN

17) AMA VIDEO CLINIC Topic: Obesity and overweight.

(SHOW) FAERIE TALE THEATRE "The Emperor's New Clothes" Art Carney and Alan Arkin play two con men who manage to make the emperor (Dick Shawn) believe he's wearing a nonexistent suit of clothes. In stereo.

SHOW BROTHERS When Joe changes Kelly's hours he realizes that she is moonlighting as a singer at another bar.

CIN ROCK AND ROLL: THE EARLY DAYS The roots of rock 'n' roll are traced through the careers of Bill Haley, the Everly Brothers, Fats Domino, Buddy Holly, Bo Diddley, Elvis Presley and others.

8:05 2) SPORTS PAGE

8:30 1) ROCK ALIVE

RODEO Mesquite Championship Rodeo from Mesquite, Texas, in stereo.

SHOW BIZARRE □

8:35 2) JERRY FALLWELL

9:00 1) SMOTHERS BROTHERS

2) MASTERPIECE THEATRE "The Irish R.M." Flurry Knox challenges a visiting maharaja's polo team to a match. (Part 5 of 6) □

3) INSIDE BUSINESS

4) TALES FROM THE DARKSIDE A literary agent (Charles Knapp) hands a gifted writer (Larry Manetti) a bizarre formula for success. (R)

5) V.J. J.J. JACKSON

6) DETENTION AT THE GOVERNMENT'S PLEASURE

7) SPORTSCENTER

8) CARDIOLOGY UPDATE

9) EVENING AT THE IMPROY Host:

Shelley Long. Comics: Johnny

Dark, (Shane) Thompson, Stanley

Myron Handleman, Barry Diamond.

Musical guest: Nicolette Larson.

HBO PHILIP MARLOWE, PRIVATE

EYE Marlowe is the prime suspect

when a hood he was hired to body-

guard is found dead. □

(SHOW) MOVIE ★★ ★ "Explorers"

(1985, Science Fiction) Ethan

Hawke, River Phoenix.

SHOW HONEYMOONERS: THE LOST

EPISODES While their apartment is

being painted the Nortons move in

with the Kramdens; Ralph has trouble

getting through a rehearsal of a

speech he is giving at the Raccoon

Lodge without being interrupted. □

(TMC) MOVIE ★★ "Alphabet City"

(1984, Drama) Vincent Spano, Kate

Vernon.

CIN MOVIE ★★ ★ "Grease" (1978,

Musical) John Travolta, Olivia New-

ton-John.

9:30 1) DENNIS THE MENACE

2) SPORTS TONIGHT

3) LOU GRANT Charlie reacts

strangely to the Trib's expose on po-

litical torture.

4) ED YOUNG

5) COUNTRY SPORTSMAN Roger

Miller goes fishing for catfish on the

Mississippi River near Helena, Miss.

in stereo.

6) LANCER

7) YOUNG ONES "Interesting"

SHOW MOVIE ★★ ★ "The Last Star-

fighter" (1984, Science Fiction)

Laqa Guest, Robert Preston.

8:35 2) JOHN ANKERBERG

9:45 1) DTV

9:55 1) NEWS

10:00 2) TAXI

3) TURKEY TELEVISION

4) 2) 3) 4) 5) (11) NEWS

6) 7) COMPUTER CHRONICLES

8) NEWS / WEATHER / SPORTS

9) MYSTERY! "Agatha Christie's

Partners in Crime" Tommy and Tup-

pence Beresford investigate the mur-

der of a masked woman during a lov-

ers rendezvous at a nightclub. (R) □

10) (12) WKRP IN CINCINNATI Andy,

bent on getting a new transmitter one

way or another, takes Momma Car-

son out after hours.

11) LARRY JONES

12) MOVIE ★★ ★ "Bella Are Ringing"

(1960, Musical) Judy Holiday, Dean

Marlin.

13) BASSMASTERS

14) V.J. J.J. JACKSON

15) ONCE IN A LIFETIME

16) RODEO

17) OC'S MINIMIZING METABOLIC

RISKS

Sunday

2) BUFFALO BILL Jo Jo faces the prospect of single parenthood when Bill won't make an honest woman out of her.

HBO MOVIE ★★ ★ "A View To A Kill" (1985, Adventure) Roger Moore, Tanya Roberts.

10:05 2) BARRY SWAGGART

10:15 2) ABC NEWS □

10:20 1) CBS NEWS

10:30 1) ALL IN THE FAMILY Archie is

interviewed by a news reporter con-

ducting a "man on the street" inter-

view.

3) MCLAUGHLIN GROUP

4) NEWS

5) STYLE WITH ELSA KLENSCH

6) W.B.C.C.J. RALLY

7) M*A*S*H When Hot Lips phones

from Tokyo to say there's "big

news," Frank assumes it's his ex-

pected promotion.

8) MUSIC CITY U.S.A.

9) (12) JEFFERSONS George's at-

tempts to get out of a painting party

and him in the state mental institu-

tion. □

10) FAME An irate student (Kenneth

Rensom) sparks racial dissension

when he voices disapproval over his

role as Jim in the play "Luck Finn." in

stereo. (R)

11) MOVIE ★★ ★ "A Ticket To

Tomahawk" (1950, Western) Dan

Dalley, Anne Baxter.

12) JOHN OSTEEN

13) WISH YOU WERE HERE Featured:

Death Valley, Calif. In stereo.

14) WANTED: DEAD OR ALIVE

15) TAKE TWO

16) PAUL HOGAN

17) CONGRESSIONAL HEARINGS,

PUBLIC POLICY ADDRESS, PRESS

CONFERENCE

18) PHYSICIAN'S JOURNAL UPDATE

19) RISING DAMP "Under the In-

fluence" Rigby is hypnotized into mak-

ing love with Ruth.

10:35 1) MOVIE ★★ ★ "Dark Of The

Sun" (1968, Adventure) Rod Taylor,

Yvette Mimieux.

10:40 2) CBS NEWS

10:45 2) TWILIGHT ZONE Two children

follow a make-believe friend into a

happier world.

(TMC) MOVIE ★ "Night School"

(1981, Mystery) Leonard Mann, Re-

chel Ward.

10:55 2) MOVIE ★★ ★ "The Gumball

Rally" (1976, Comedy) Michael Sar-

Sunday

rezin, Tim McIntire.

11:00 **7** CBS NEWS

1 MISTER ED "Ed, The Godfather"

2 NEWS UPDATE / HEALTHWEEK

3 ALICE An elderly Indian claims the diner is built on his tribal burial grounds and announces that he has come there to die.

4 CIVIC DIALOGUE

5 DEJA VU A nostalgic review of hit songs that includes videos of "The Letter" by the Box Tops, "American Pie" by Don McLean, "I Can't Get Next to You" by the Temptations and "It's My Party" by Lesley Gore. Also, live performances by Felix Cavaliere, Richard Manuel, Peter Noone, Ronnie Spector and host John Sebastian. In stereo. (R)

6 (12) CAROL BURNETT AND FRIENDS Skits: The Alibi, Toilet Tissue, Just A Gigolo.

7 MY CHILDREN ARE DYING

8 HIDDEN HEROES

9 COVER STORY Featured: Alan Thicke discusses his new situation comedy "Growing Pains."

10 120 MINUTES

11 LIFESTYLES OF THE RICH AND FAMOUS A look at the money and glamour surrounding horses including an interview with Prince Charles on the celebrity sport of polo. (R)

12 HORIZON

13 BOWLING American Bowling Congress Bud Light Masters Tournament, from Las Vegas. (R)

14 INSIDE THE THIRD REICH Albert Speer ignores the plea of his family and assumes the responsibility for Hitler's war machine, though he does defy Hitler's last order to level all of Germany. (Part 2 of 2)

15 (SHOW) BROTHERS When Joe changes Kelly's hours he realizes that she is moonlighting as a singer at another bar. **16**

17 CIN CINEMAX COMEDY EXPERIMENT The comic style of Eric Bogosian is showcased in this spoof on drinking in America.

11:05 **18** ROCKFORD FILES

19 WORLD TOMORROW

11:10 **20** ENTERTAINMENT THIS WEEK

An interview with Bruce Boxleitner.

11:15 **21** INTERACTION

22 HAWAII FIVE-O Five-O is confronted by a series of five rape-murders. **23** SHOW MOVIE ** "Mike's Murder" (1984, Drama) Debra Winger, Mark Keyloun.

11:30 **24** DONNA REED Donna secretly writes about the Stone family.

25 NIGHTMAKER SUNDAY

26 LAVEY & SHIRLEY A little white lie brings on a nightmare for Shirley.

27 GOVERNOR'S NEWS CONFERENCE

28 GEORGE MICHAEL'S SPORTS MACHINE

29 (12) CANYON FORUM

30 STAR GAMES Sports competition featuring cast members from "Falcoo Crest," "Days of Our Lives" and "General Hospital." Final round. (R)

31 MOVIE *** "The Old Currier" (1937, Western) Gene Autry, Hope Manning.

32 HOLLYWOOD INSIDER

33 PHYSICIAN'S JOURNAL UPDATE

(SHOW) BIZARRE **34** CIN MOVIE *** "Birdy" (1984, Drama) Matthew Modine, Nicholas Cage.

11:35 **35** LARRY JONES

12:00 **36** MOVIE *** "The Divorce of Lady X" (1938, Comedy) Merle Oberon, Laurence Olivier.

37 MONEYWEEK

38 HAPPY DAYS Fonzie hires a recently disabled mechanic who bitterly rejects any offer of friendship.

39 700 CLUB

40 GO FOR YOUR DREAMS: CASH FLO EXPO

41 SCTV

42 HUMAN FOIBLE

43 WORLD CUP SOCCER SPECIAL (SHOW) HONEYMOONERS: THE LOST EPISODES While their apartment is being painted the Nortons move in with the Kramdens; Reiph has trouble getting through a rehearsal of a speech he is giving at the Raccoon Lodge without being interrupted. **44**

12:05 **45** MOVIE *** "Our Time" (1973, Drama) Pamela Sue Martin, Parker Stevenson.

46 CHRISTIAN CHILDREN'S FUND

12:10 **47** ON LOCATION: PARENT TRAP II The Disney camera goes to Florida to capture a behind-the-scenes look at the making of the new film "Parent Trap II."

48 MOVIE ** "The Man With the Power" (1977, Horror) Bob Neill, Vic Morrow.

12:15 **49** MORK AND MINDY Mork journeys back in time to Mindy's high school prom to see if she would have loved him if she knew him then.

50 HBO RAPISTS: HOW CAN THEY BE STOPPED? This documentary, focusing on five case studies of men at the Oregon State Penitentiary, deals with why men rape and examines the men who commit this crime.

12:30 **51** SPORTS LATE NIGHT

52 NEWS

53 AT THE MOVIES Scheduled reviews: "Legal Eagles" (Robert Redford, Dabre Wingor, Daryl Hannah); "Desert Hearts" (Helen Shaver, Patricia Charbonneau); "Spring Symphony" (Nastassja Kinski).

54 MOVIE *** "The Private Life of Henry VIII" (1933, Drama) Charles Laughton, Elsa Lanchester.

55 WHICKER'S WORLD

56 SPORTSCENTER

(SHOW) MOVIE *** "The Last Starfighter" (1984, Science Fiction) Lance Guest, Robert Preston.

12:35 **57** MOVIE ** "Blondie Goes Latin" (1941, Comedy) Penny Singleton, Arthur Lake.

12:55 **58** FACES

1:00 **59** NEWS / WEATHER / SPORTS

60 INDEPENDENT NEWS

61 700 CLUB

62 GET RICH WITH REAL ESTATE

63 KEYS TO SUCCESS

64 VJ: J.J. JACKSON

65 NIGHTWATCH

66 HYDROPLANE RACING 1985 season highlights.

67 AMA VIDEO CLINIC Topic: Obesity and overweight.

68 EVENING AT THE IMPROV Host: Shelley Winters. Comics: Johnny Dark, Shawn Thompson, Stanley Myron Handelman, Barry Diamond.

Musical guest: Nicolette Larson. (TMC) MOVIE *** "Vision Quest"

(1985, Drama) Matthew Modine, Linda Fiorentino.

1:10 SHOW MOVIE *** "Explorers" (1985, Science Fiction) Ethan Hawke, River Phoenix.

1:20 HBO MOVIE *** "Vision Quest" (1985, Drama) Matthew Modine, Linda Fiorentino.

1:30 **69** CROSSFIRE

70 AMERICA'S TOP TEN

71 ROOM 222

72 CONGRESSIONAL HEARINGS, PUBLIC POLICY ADDRESS, PRESS CONFERENCE

73 CIN MOVIE ** "Partners" (1982, Comedy) Ryan O'Neal, John Hurt.

2:00 **74** TURKEY TELEVISION

75 NEWS UPDATE / SHOWBIZ WEEK

76 AGRICULTURE U.S.A.

77 MOVIE ** "Hold That Hypnotist" (1957, Comedy) Bowery Boyz, Huntz Hall.

78 BREAK THRU TO WEIGHT LOSS

79 SECRETS FOR SUCCESS

80 VJ: NINA BLACKWOOD

81 PGA SENIORS GOLF Tournament Playoffs Championship, final round, from Cleveland. (R)

82 CARDIOLOGY UPDATE

2:05 **83** MUSIC CITY U.S.A.

2:15 (SHOW) MOVIE ** "Mike's Murder" (1984, Drama) Debra Winger, Mark Keyloun.

2:30 **84** BIG STORY

85 IT'S YOUR BUSINESS

2:35 **86** ABC NEWS **87**

2:50 **88** NEWS

2:55 (TMC) MOVIE *** "Our Very Own" (1950, Drama) Ann Blyth, Farley Granger.

3:00 **89** ROUTE 66

90 SPORTS REVIEW

91 BOB NEWHART

92 INSTANT CASH SYSTEMS

93 VICTORY OVER IRS AUDITS

94 BRIEF SUMMARIES

SHOW THE WONDERFUL WORLD OF THE WOMBLES Animated. Fat and fuzzy creatures, the Wombles, want a clean world and embark on a mission to teach humans how to pick up after themselves.

CIN BRITISH ROCK: THE FIRST WAVE A montage of clips of the Beatles, The Rolling Stones, The Kinks and The Who highlight this look at the British rock invasion of the mid-60's.

3:15 HBO MOVIE ** "Raw Courage" (1984, Adventure) Ronnie Cox, Art Hindle.

3:30 **95** INSIDE BUSINESS

96 BEVERLY HILLS 90210

97 MOVIEONE NEWS

4:00 **98** ADVENTURES OF BLACK BEAUTY

99 DAYBREAK

100 NEWS

101 KEY TO SUCCESS

102 JIMMY SWAGART

103 WIN AT BLACKJACK

104 WRESTLING

105 VJ: NINA BLACKWOOD

106 AEROBICS

107 SUCCESS IS NOT AN ACCIDENT CIN MOVIE *** "Goodbye, New York" (1985, Comedy) Julie Hagerty, Amos Kollek.

4:10 (SHOW) MOVIE *** "Explorers" (1985, Science Fiction) Ethan Hawke, River Phoenix.

4:30 **108** NICK ROCKS: VIDEO TO GO

109 BUSINESS MORNING

110 FUNTIME

- ① FAITH 20
- ② HONEY, HONEY
- ③ CONGRESSIONAL HEARINGS, PUBLIC POLICY ADDRESS, PRESS CONFERENCE
- ④ NATION'S BUSINESS TODAY

SHOW JOSHUA'S CONFUSION An Amish boy tries to bridge the gap between his family's simple lifestyle and his schoolmates' luxurious world. (TMC) MOVIE ★★½ "Cold Feet" (1983, Comedy) Griffin Dunno, Marle-

as Chiles.
4:50 HBO MOVIE ★★½ "The Amateur" (1982, Drama) John Savage, Christopher Plummer.

Joyce teams with 'Dating Game'

LOS ANGELES (AP) — Elaine Joyce says she got interested in game shows when her acting career was a drift.

"It was after the birth of my first child and I wanted to stay in town," she said. "So around 1978 I started doing shows like 'The Match Game,' 'Hollywood Squares' and 'Password.' The game shows were all over the place, I got into it originally because of 'Pyramid' in New York. That was the first game show I did.

"I loved going on the game shows as a guest. You get a mental workout and it's fun. You can be yourself. People just kept calling me for them. At that time I was kind of directionless in my career. Whoever called I'd work for."

Miss Joyce is now moving up from guest to host of "The All New Dating Game." She starts taping Wednesday for syndication on 130 stations in the fall.

She did a pilot for a talk show for Chuck Barris about a month ago, then Barris asked her if she would be host when he revived "The Dating Game."

"We did a run-through," she said. "I was very excited. This is going to be fun. It was like putting on a comfortable pair of shoes."

Traditionally, men have been game-show hosts. One exception was Betty White, who won an Emmy in 1983 as host of NBC's daytime show "Just Men!"

"This is rare. I think women have a lot to say, it's just that we need a vehicle," Miss Joyce said. "I remember being asked a few years ago to be co-host of a show. I said I'll be the host, but I'm not going to stand there like a model. They said, 'No, no, women don't want to see a woman as a host.'"

"So much has changed in this country, but dating was one of the last things to change," she said. "A guy asks a girl out, then he takes her home. Now there's computer dating, you go Dutch. I thought I knew all about male-female relationships, but when I got out there and had to start dating again I didn't know what to say. It had changed. Men are scared. They don't know how to approach women any more because

of all the stuff about women's liberation."

Miss Joyce's second child, Michael Francis Levoff, was born three months ago. Her first child, a daughter, Taylor Joyce Van, is now 9. She was married for 12 years to the late actor-singer Bobby Van. She now is married to John D. Levoff, a film executive.

Miss Joyce recently completed a role in the horror film "Trick or Treat," which was filmed at the Dino De Laurentiis studio near Wilmington, N.C.

"There were eight films going when I was there," she said. "When I arrived at the airport there was King Kong's arm, for the sequel. I saw the forklift used in the heart transplant. It was hysterical."

She described "Trick or Treat" as a funny rock 'n' roll horror film. It also stars rock stars Gene Simmons from Kiss and Ozzy Osbourne.

She will also be seen this summer in "Up Hill All the Way," a comedy starring Mel Tillis, Roy Clark, Burt Reynolds and Glen Campbell.

Most of her work has been on television, where she starred in "Mr. Merlin," "City of Angels," "The Carol Burnett Show," "The Don Knotts' Variety Show," and "Here Come the Brides."

"The first thing I ever did was 'Here Come the Brides.' I was one of the brides," she said. "It was set in Seattle and they took us out in the harbor on a tug, which started sinking. The boat was sinking and we were in these heavy dresses from the 1800s."

Carlin turns to acting

LOS ANGELES (AP) — Comedian George Carlin waited a long time to become an actor, but he quickly nailed down roles in a special for Home Box Office and in a movie now in production.

He's a burned-out hippie who tuned out in the 1960s in the Disney comedy spy thriller "Outrageous Fortune," now filming in Los Angeles.

"This is important for me because I held my acting ambitions in check because I'd had some bad experiences with trying to do some acting in the 1960s and '70s," he said. "Acting is something I've always wanted to do since childhood."

"I didn't feel confident before. Now I've worked past most of those internal blocks. I'm free now to pursue this deferred goal. The main kickoff to show people, the public and people in this business that I'm ready is 'Outrageous Fortune.' But my special is another step in that direction."

Carlin stars in his sixth original special for HBO, "On Location:

George Carlin in Concert — Play'n' With Your Head." The difference this time is that the special includes a short film, done in black and white like a 1940s detective movie, called "The Envelope." In it private eye Mike Holder is trying desperately to evade hoodlums who want the envelope he holds.

DEFECTIVE PRODUCT?

If you have suffered damages as a result of using a defective product, you may be wise to seek legal advice.

FREE CONSULTATIONS

Offices
Statewide

Goicoechea Law Office
 Accident and Injury Claims
 Settlements & Trials
Twin Falls 734-1352

Monday evening programs

6:00 **(1)** **(3)** **(7)** **(8)** **(10)** **(11)**
NEWS
(1) MY THREE SONS
(3) BUSINESS REPORT
(4) WHEEL OF FORTUNE
(5) PRIMENEWS
(7) WILD, WILD WORLD OF ANIMALS The cobra is only one of a wide range of exotic snakes that in-

habit the Indian subcontinent.
(8) MOVIE ★★ "Joe Panther" (1970, Adventure) Brian Keith, Ricardo Montalban.
(10) WKRP IN CINCINNATI Herb develops chest pains and secretly checks into a hospital.
(11) FATHER MURPHY A young boy takes part in a bank robbery to get

the money he needs to care for his sick mother.
(12) NEW! ANIMAL WORLD
(13) NASHVILLE NOW
(14) CHAIN REACTION
(15) ENTERTAINMENT TONIGHT Interview with Daniel J. Travanti ("Hill Street Blues").
(16) VISTA
(17) CONGRESSIONAL HEARING
(18) NATIONAL HIGH SCHOOL DANCE TEAM CHAMPIONSHIPS
(19) COVER UP
(20) MAELSTROM Catherine's curiosity about the mysterious island nearly results in tragedy. (Part 2 of 6)
HBO WIMBLEDON TENNIS Same-day early round coverage from London.
SHOW MOVIE ★★ "The River" (1984, Drama) Mel Gibson, Sissy Spacek.

Daytime movies

5:00 **SHOW ★★★★★ "Hans Christian Andersen"** (1952, Musical) Danny Kaye, Jeanne Marie.
 5:35 **CIN ★★ "Covergirl"** (1983, Drama) Jeff Conaway, Irena Ferris.
 6:00 **(10) ★★★★★ "The Seventh Veil"** (1946, Drama) James Mason, Ann Todd.
(TMC) ★★★★★ "Harold And Maude" (1971, Comedy) Ruth Gordon, Bud Cort.
 7:15 **CIN ★★ "Out Of The Past"** (1947, Drama) Kirk Douglas, Jane Greer.
 8:00 **(11) ★★★★★ "Lydia"** (1941, Drama) Merle Oberon, Joseph Cotten.
(SHOW) ★★★★★ "Hans Christian Andersen" (1952, Musical) Danny Kaye, Jeanne Marie.
SHOW ★★ "Ceiling Zero" (1935, Drama) James Cagney, Pat O'Brien.
(TMC) ★★ "Reuben, Reuben" (1983, Drama) Tom Conti, Kelly McGillis.
 8:05 **(3) ★★ "The Disappearance Of Aimee"** (1976, Drama) Faye Dunaway, Belto Davis.
 9:00 **HBO ★★★★★ "Carolul, He Might Hear You"** (1983, Drama) Wendy Hughes, Robyn Nevin.
CIN ★★ "Crooks And Coronets" (1969, Comedy) Telly Savalas, Edith Evans.
 10:00 **SHOW ★★ "The River"** (1984, Drama) Mel Gibson, Sissy Spacek.
(TMC) ★★ "Up In Arms" (1944, Comedy) Danny Kaye, Dinah Shore.
 10:30 **(1) ★★ "The Secret Of N.I.M.H."** (1982, Fantasy) Animated. Voice of Elizabeth Hartman, Dom DeLuise.
 11:00 **(3) ★★ "The Old Corral"** (1937, Western) Gene Autry, Hope Manning.
HBO ★★ "9 To 5" (1980, Comedy) Jane Fonda, Dolly Parton.
(SHOW) ★★ "Ceiling Zero" (1935, Drama) James Cagney, Pat O'Brien.
CIN ★★ "Romancing The Stone" (1984, Adventure) Michael Douglas, Kathleen Turner.

11:05 **(3) ★★ "Caxambu"** (1968, Adventure) John Ireland, Carol Ohmart.
 11:30 **(TMC) ★★ "Cold Feet"** (1983, Comedy) Griffin Dunno, Marissa Chibas.
 12:05 **SHOW ★★ "Bitter Harvest"** (1981, Drama) Ron Howard, Art Carney.
 1:00 **(10) ★★★★★ "The Seventh Veil"** (1946, Drama) James Mason, Ann Todd.
HBO ★★ "Misunderstood" (1984, Drama) Gene Hackman, Henry Thomas.
(SHOW) ★★ "The River" (1984, Drama) Mel Gibson, Sissy Spacek.
(TMC) ★★ "I Want You" (1952, Drama) Dana Andrews, Dorothy McGuire.
CIN ★★★★★ "These Three" (1936, Drama) Miriam Hopkins, Merle Oberon.
 2:00 **(10) ★★ "Royal Wedding"** (1951, Musical) Fred Astaire, Jane Powell.
(11) "Glass Babies" (1985, Drama) (Part 1 of 2) Belinda Davay, Gary Day.
 3:00 **(10) ★★ "Lucky Jim"** (1956, Comedy) Ian Carmichael, Terry-Thomas.
HBO ★★ "Romantic Comedy" (1983, Romance) Dudley Moore, Mary Steenburgen.
CIN ★★★★★ "The Hunter" (1970, Drama) Steve McQueen, Eli Wallach.
 3:05 **(SHOW) ★★ "Bitter Harvest"** (1981, Drama) Ron Howard, Art Carney.
 3:30 **(TMC) ★★ "Reuben, Reuben"** (1983, Drama) Tom Conti, Kelly McGillis.
 4:00 **SHOW ★★ "Hans Christian Andersen"** (1952, Musical) Danny Kaye, Jeanne Marie.
 5:30 **(TMC) ★★ "Hambone And Hillie"** (1984, Comedy) Lillian Gish, Timothy Bottoms.
CIN ★★ "The Thing" (1951, Science-Fiction) James Arness, Dowey Martin.

6:30 **(1)** **(10)** **(11) WHEEL OF FORTUNE**
(3) MISTER ED "Ed's Contact Lenses"
(10) WILD AMERICA A look at the ways a variety of fish adapt to their environment in North American waters. **(1)**
(11) JEOPARDY
(3) BENSON Benson wins a state lottery, but complaints of a fix pose a dilemma on use of the money.
(10) ALICE Mel hires a man at the diner for more money than he's paying the waitress.
(7) BUSINESS REPORT
(10) M*A*S*H The 4077th receives two bottles of alcohol for secret surgery and a tank to scare off snipers.
(12) NEWLYWED GAME
(10) DONALD DUCK PRESENTS
(10) ALL-STAR BLITZ
(10) PM MAGAZINE John Denver's Windstar Foundation; computer animation.
(6) 100,000 PYRAMID
(10) PRIME TIME ACCESS
 7:00 **(1)** **(10)** **(11) SCARECROW AND MRS. KING** Amanda's mother is swept off her feet by a Soviet spy. (R)
(1) ISPY
(10) MACNEIL / LEHRER NEWS HOUR
(4) **(6)** **(10) INSIDERS** Nick declares war on street crime when he's wounded in a gang-war shoot-out. In stereo. (R) **(1)**

Daytime sports

6:30 **(1) SPORTSCENTER**
 7:00 **(1) OUTDOOR LIFE**
 7:30 **(1) PGA SENIORS GOLF** Tournament Players Championship, first round, from Cleveland. (R)
 9:30 **(1) SPORTSLOOK**
 11:00 **(1) NCAA COLLEGE WORLD SERIES** Game 15, from Omaha, Neb. (R)
 3:00 **(1) FLY FISHING WITH JOE HUM-**

PHREYS
 3:30 **(1) WORLD OF SPORTS**
 4:00 **(1) SPORTSLOOK**
 4:30 **(1) FISHING: JOHN FOX'S OUTDOOR ADVENTURES**
 5:00 **(1) SPORTSCENTER**
 6:30 **(1) BASEBALL** Chicago Cubs at Philadelphia Phillies (Live)
(1) INSIDE BASEBALL



6 a.m. (USA) **The Seventh Veil** Fans of James Mason will want to see this 1943 film about a harried English girl (Ann Todd) who runs away from her family to become a pianist, sharing her life with various men along the way: Mason, Herbert Lom, Hugh McDermott.

MONDAY EVENING

| | 7:00 | 7:30 | 8:00 | 8:30 | 9:00 | 9:30 | 10:00 | 10:30 | 11:00 | 11:30 | 12:00 | 12:30 |
|------|----------------------------------|------|--------------------------|---------|-----------------------|------|--------------------------|----------------|-----------------|-------------------------|-------|-----------|
| 7 | Scarecrow | | K. & Alie | Newhart | Cagney & Lacey | | News | B. Miller | Magnum, P.I. | | Movie | |
| 8 | MacNeil / Lehrer | | Trojan War Search | | Kid Who Couldn't Miss | | | America | A. Keresz | | | |
| 6 | Insiders | | Movie | | | | News | Entertain | Nightline | Hawaii Five-0 | | |
| 7 | Movie: "Liberty" | | | | | | News | Dest Of Carson | | David Letterman | | News |
| 9 | Star Trek | | Movie: "The April Fools" | | | | Jefferons | Quincy | | C. Burnett | | Ind. News |
| 12 | Scarecrow | | K. & Alie | Newhart | Cagney & Lacey | | News | M*A*S*H | Magnum, P.I. | | Movie | |
| SHOW | Movie: "Hans Christian Andersen" | | | | Movie: "The River" | | | | | Movie: "Vision Quest" | | |
| SHOW | Movie Cont'd | | Movie: "Vision Quest" | | | | Movie: "Lost In America" | | | Movie: "Model Behavior" | | |
| NBO | Wimbledon Tennis Cont'd | | Wimbled. | | Movie: "9 To 5" | | | | Movie: "Tomboy" | | | Wimbled. |

- 3 LARRY KING LIVE**
7 (8) MOVIE "Liberty" (Premiere, Drama) Frank Langella, George Kennedy.
(7) IN SEARCH OF THE TROJAN WAR The archaeological, historical and literary evidence regarding the fall of Troy is summed up and a new possibility is presented. **(7)**
(12) STAR TREK Rebels capture the Enterprise and threaten its destruction unless they are taken to the planet Eden.
11 700 CLUB
10 MOVIE ★★ "The Young Runaways" (1977, Drama) Gary Collins, Anne Francis.
10 CARTOONS
11 V.J.: MARK GOODMAN
10 ISLAND WILDLIFE
10 DIVING McDonald's International Invitational, from Fort Lauderdale, Fla. (R)
10 REGIS PHILBIN'S LIFESTYLES
10 DIANA Jan is badly wounded as his dangerous mission comes to an end.
(SHOW) MOVIE ★★★★★ "Hans Christian Andersen" (1952, Musical) Danny Kaye, Jeanne Marie.
(TMC) MOVIE ★★ "Weekend Pass" (1984, Comedy) D.W. Brown, Peter Ellenstein.
CIN MOVIE ★★ "Turk 1821" (1985, Drama) Timothy Hutton, Robert Ulrich.
7:30 10 NEW COUNTRY
10 VIEWER CALL-IN
8:00 (7) (8) (9) (11) KATE & ALLIE Kate imagines what life with Allie will be like when they become senior citizens. (R)
(7) ROUTE 66 A 9-year-old orphan asks Baz and Tod for help when her alcoholic guardian (Dan Duryea) is called into court.
(7) (10) IN SEARCH OF THE TROJAN WAR The archaeological, historical and literary evidence regarding the fall of Troy is summed up and a new possibility is presented. **(7)**
(7) (8) MOVIE ★★ "The Night The Lights Went Out In Georgia" (1981, Drama) Kristy McNichol, Mark Hamill.
9 NEWS
(7) EXPLORE Explorers face headhunters and carnivorous plants in the jungles of Borneo in Southeast Asia. (Part 1 of 2)
(7) (12) MOVIE ★★ "The April Fools" (1967, Comedy) Jack Lemmon, Catharine Deneuve.
10 CROOK AND CHASE
10 RADIO 1950

10 NEW VIDEO HOUR

- 10 ASIAN INSIGHTS**
10 DR. RUTH SHOW
10 ONE BY ONE "Of Babes And Sucklings" Turner discovers operators of a circus act are smuggling baby orangutans into Britain.
8:05 SHOW MOVIE ★★ 1/2 "Vision Quest" (1985, Drama) Matthew Modine, Linda Fiorentino.
8:30 (7) (8) (9) (11) NEWHART Stephanie's father (Jose Ferrer) and Dick wind up in jail as a result of their untoward behavior during Stratford's Colonial Days festival. (R) **(7)**
10 BASEBALL Atlanta Braves at Los Angeles Dodgers (Live)
10 NEWS
11 TAKING STOCK
10 VIDEOCOUNTRY
10 WILD, WILD WORLD OF ANIMALS
10 TODAY IN WASHINGTON
10 SYNCHRONIZED SWIMMING McDonald's U.S. Championships, duet competition, from Fort Lauderdale, Fla. (R)
HBO WIMBLEDON TENNIS Highlights of the day's matches.
8:40 10 MOUSETERPIECE THEATER
9:00 (7) (8) (9) (11) CAGNEY & LACEY Cagney has difficulty coping with a suspension and a visit from her estranged brother. (R) **(7)**
10 MOVIE ★★ 1/2 "Cyrano De Bergerac" (1950, Drama) Jose Ferrer, Mala Powers.
10 KID WHO COULDN'T MISS This portrait of Billy Bishop juxtaposes archival battle footage, old movie scenes and interviews with his war buddies with excerpts from Eric Peterson's portrayal of the Canadian World War I flying ace in the play, "Billy Bishop Goes to War." (R) **(7)**
10 MONEYLINE
10 AMERICAN MASTERS "Private Conversations: On the Set of 'Death of a Salesman'" (Premiere) Host Joanne Woodward examines American art and artists beginning with a behind-the-scenes look at how the Broadway production of "Death of a Salesman" was adapted for TV. Playwright Arthur Miller and actor Dustin Hoffman are featured. **(7)**
11 BILL COSBY
10 STILL THE BEAVER "Escape From The Salt Mines"
10 YOU CAN BE A STAR
10 WRESTLING
10 AMERICAN ANTHEM PARTY
10 IN THE WILD WITH HARRY BLITZ

Monday

- LER**
10 MOVIE "Body Business" (1983, Drama) (Part 1 of 2) Jane Fonda, Carmen Duncan.
10 NANNY Barbara expresses concern for the Duchess of Braughton who seems depressed after Lord John's birth.
HBO MOVIE ★★ "9 To 5" (1980, Comedy) Jane Fonda, Dolly Parton.
(SHOW) MOVIE ★★ "The River" (1984, Drama) Mel Gibson, Sissy Spacek.
(TMC) MOVIE ★★ "Up In Arms" (1944, Comedy) Danny Kaye, Dinah Shore.
CIN MOVIE ★★ "Flashpoint" (1984, Drama) Kris Kristofferson, Treat Williams.
6:30 10 SPORTS TONIGHT
(7) TRAPPER JOHN, M.D.
10 BURNS AND ALLEN Harry doesn't know it, but Blanco secretly purchases a mink and is hiding it in Gracie's home.
10 MOVIE ★★ 1/2 "The Cruel Sea" (1953, Drama) Jack Hawkins, Donald Sinden.
10 FANDANGO
10 STATIONARY ARK
10 SPORTSCENTER
10:00 (7) (8) (9) (11) (12) (13) (14) (15) (16) (17) (18) (19) (20) (21) (22) (23) (24) (25) (26) (27) (28) (29) (30) (31) (32) (33) (34) (35) (36) (37) (38) (39) (40) (41) (42) (43) (44) (45) (46) (47) (48) (49) (50) (51) (52) (53) (54) (55) (56) (57) (58) (59) (60) (61) (62) (63) (64) (65) (66) (67) (68) (69) (70) (71) (72) (73) (74) (75) (76) (77) (78) (79) (80) (81) (82) (83) (84) (85) (86) (87) (88) (89) (90) (91) (92) (93) (94) (95) (96) (97) (98) (99) (100)
(11) NEWS
10 NEWSNIGHT
(12) JEFFERSONS Feeding out of place with Helen's old school friends, Tom turns to George for help. **(7)**
10 JACK BENNY Jack sings an operatic excerpt with Roberta Peters



9 p.m. (NICKELODEON) **Cyrano de Bergerac** Jose Ferrer won an Oscar for his portrayal of the tragic wit, famed for his ample nose, but longing for the love of a beautiful woman. This 1950 classic was directed by Michael Gordon and also stars Mala Powers and William Prince.

and Don Wilson.

① NASHVILLE NOW

② V.J. MARK GOODMAN

③ AUSTRALIAN ARK

④ AUTO RACING Acropolis Rally, from Athens. (R)

⑤ MAELSTROM Catherine's curiosity about the mysterious Island nearly results in tragedy. (Part 2 of 6)

⑥ SHOW MOVIE ★★½ "Lost in America" (1985, Comedy) Albert Brooks, Julie Hagerty.

10:30 ⑦ BARNEY MILLER The financially ailing city plans to save money by closing the precinct.

⑧ WILD AMERICA A look at the ways a variety of fish adapt to their environment in North American waters. (R)

⑨ BEST OF CARSON From April 1985: actors Drew Barrymore and Joe Penny and singer Maureen McGovern join host Johnny Carson. In stereo. (R)

⑩ DOCTOR WHO "The Revenge Of The Cybermen" The Doctor returns to the Ark to recover the Tardis but discovers things have changed. (Part 1 of 4)

⑪ QUINCY Quincy investigates a smuggling ring in Las Vegas after he finds valuable diamonds inside a body.

⑫ MOVIE ★★½ "They Came To Cordura" (1959, Adventure) Gary Cooper, Rita Hayworth.

⑬ (11) M*A*S*H Col. Potter is overwhelmed by the attention he receives as his staff tries to reduce his blood pressure before his annual physical.

⑭ BEST OF GROUCHO CIN MAXTRAX

10:35 ⑮ TAXI Alex's romantic affair with a beautiful television soap actress leads to thoughts of matrimony.

⑯ WKRP IN CINCINNATI

⑰ ENTERTAINMENT TONIGHT Interview with Danlet J. Travanti ("Hill Street Blues").

⑱ BEST OF CARSON From April 1985: actors Drew Barrymore and Joe Penny and singer Maureen McGovern join host Johnny Carson. In stereo. (R)

⑲ NIGHTLINE

10:40 ⑳ M*A*S*H

11:00 ㉑ (11) MAGNUM, P.I. Magnum comes to the aid of an innocent

bystander injured while he was pursuing criminal suspects. (R)

㉒ MISTER ED "Ed's Contact Lenses"

㉓ ANDRE KERTESZ: A POET WITH THE CAMERA Completed just before his death in 1985 at age 91, this portrait of photojournalist pioneer Andre Kertesz features the artist's reflections on his life and art.

㉔ CROSSFIRE

㉕ GREAT PERFORMANCES "Man From Moscow" Wynne goes to Moscow, planning to help Pankovskiy get out of Russia before the leak in Soviet security is discovered. (Part 2 of 3) (R) (C)

㉖ DOBIE GILLIS

㉗ BEST OF THE SUPERFEST Performers include Kool & The Gang, Fatti Labella, The Mary Jane Girls and The O'Jays for this concert special taped at the Summit in Houston. Host: Lou Rawls.

㉘ ODYSSEY

㉙ SUPERSBOUTS Sugar Ray Leonard vs. Wilfred Benitez, taped Nov. '79 in Las Vegas, Nev. (R)

㉚ EVERYBODY'S MONEY MATTERS

㉛ DIANA Jan is badly wounded as his dangerous mission comes to an end.

HBO MOVIE ★★ "Tomboy" (1984, Comedy) Betsy Russell, Jerry DiNomo.

(TMC) MOVIE ★★ "The Sensuous Nurse" (1979, Comedy) Ursula Andress, Duilio Del Prete.

CIN MOVIE ★★ "The Evil That Men Do" (1984, Suspense) Charles Bronson, Theresa Saldana.

11:05 ㉜ MAGNUM, P.I. Magnum comes to the aid of an innocent bystander injured while he was pursuing criminal suspects. (R)

㉝ JEFFERSONS

㉞ NIGHTLINE

㉟ 700 CLUB (SHOW) MOVIE ★★½ "Vision Quest" (1985, Drama) Matthew Modine, Linda Fiorentino.

11:10 ㊱ MAGNUM, P.I. Magnum comes to the aid of an innocent bystander injured while he was pursuing criminal suspects. (R)

11:15 ㊲ MOVIE ★★ "Stage Struck" (1957, Drama) Henry Fonda, Susan Strasberg.

11:30 ㊳ DONNA REED Donna fears that the city will cut down her carob tree.

㊴ NEWSNIGHT UPDATE

㊵ LATE NIGHT WITH DAVID LETTERMAN Scheduled: comedian John Witherspoon, debutante-author Cornelia Guest. In stereo.

㊶ (12) CAROL BURNETT AND FRIENDS Skills: Good-Bye Charlie, Soap Opera.

㊷ FATHER KNOWS BEST Margaret has a problem of conflicting dates when Jim goes to New York and she has a club meeting planned.

㊸ NEW COUNTRY

㊹ TODAY IN WASHINGTON

11:35 ㊺ ROCKFORD FILES

㊻ HAWAII FIVE-O McGarrett fights to save the life of a displaced gangster whose testimony is needed to convict a crime boss.

㊼ DISNEY CHANNEL PREVIEW

㊽ ENTERTAINMENT TONIGHT Interview with Danlet J. Travanti ("Hill Street Blues").

11:40 SHOW MOVIE "Model Behavior" (1985, Comedy) Bruce Lyons, Richard Belkin.

12:00 ㊾ SPY

㊿ OK HEART Efforts by Wyoming Valley (Pa.) residents to reduce their risk of contracting heart disease through community awareness programs and the establishment of healthful habits. Host: Cliff Robertson.

(12) INDEPENDENT NEWS

700 CLUB

ADVENTURES OF OZZIE & HARRIET "Ozzie Keeps A Secret" Ozzie finds out that Ricky isn't very good at keeping secrets when he makes plans to get Ricky's girlfriend to surprise birthday party in her honor.

FIRE ON THE MOUNTAIN

ALFRED HITCHCOCK HOUR

V.J. J.J. JACKSON

JAPANESE EXPERIENCE

SPORTSBOOK

ONE BY ONE "Of Babes And Sucklings" Turner discovers the actors of a circus act are selling baby oranges into Britain.

12:05 ㊿ LATE NIGHT WITH DAVID LETTERMAN Scheduled: comedian John Witherspoon, debutante-author Cornelia Guest. In stereo.

㊿ JIMMY SWAGART

(11) MOVIE ★★½ "Great Catherine" (1968, Comedy) Peter O'Toole, Jeanne Moreau.

12:15 ㊿ MOVIE ★★ "Great Catherine" (1968, Comedy) Peter O'Toole, Jeanne Moreau.

12:20 ㊿ MOVIE ★★ "Great Catherine" (1968, Comedy) Peter O'Toole, Jeanne Moreau.

12:30 ㊿ SPORTS LATENIGHT

NEWS

MOVIE ★★ "The Eagle's Wing" (1979, Western) Martin Sheen, Sam Waterston.

DANCIN' USA

SPORTSCENTER

HBO WIMBLEDON TENNIS Highlights of the day's matches.

CIN CRAZY ABOUT THE MOVIES: STEVE MCQUEEN Film clips from "Bullitt" and "The Sand Pebbles" as well as television footage and interviews with friends, family and co-workers including his first wife, Nellie McQueen, Chuck Norris, Karl Malden, Shelley Winters and directors Robert Wise and Norman Jewison, are featured in this look at the life of Steve McQueen.

12:35 ㊿ BENNY HILL

12:55 HBO MOVIE ★★ "Everything You Always Wanted To Know About Sex (But Were Afraid To Ask)" (1972, Comedy) Woody Allen, Gene Wilder.

1:00 ㊿ ROUTE 66 A 9-year-old orphan asks Buz and Tod for help when her alcoholic guardian (Dan Duryea) is called into court.

NEWS OVERNIGHT

COMEDY BREAK

MOVIE ★★ "Hpartaches" (1947, Drama) Sheila Ryan, Edward Norton.

BEST OF MONEY, MONEY

EDGE OF NIGHT

INSIDE BASEBALL

MAKING MONEY WITH CARBON

NANNY Barbara expresses her



1:15 a.m. (Tuesday) (WTBS) Take the Money and Run Woody Allen's first effort as writer/director/star was a comic success, as he parades a non-stop chain of jokes and sight gags involving the story of a compulsive criminal. Allen's use of a documentary style began here, and was refined in his later films. A favorite gag: Allen and a troupe of escaped road-gang convicts, all chained together, trying to ride a bicycle down a country lane.

SEARS PORTRAIT STUDIO

We Bring Out the Best in Babies!

995
18-piece
portrait collection
plus 95' sitting fee

3-5x7s and 15 wallets on your
choice of a traditional, nursery,
spring or fall background

At Sears, no appointment is ever
necessary to get professional qual-
ity photographic portraits. We wel-
come adults and family groups.
Each additional person is only 95c.
POSES OUR SELECTION. These
attractive options available in addi-
tion to this offer: White Back-
ground, Black Background and
Double Feature Portraits. Use your
Sears Credit Card!

Also available: Instant Color Pass-
port Photos, Copy & Restoration.

OFFER FOR PORTRAITS TAKEN THRU JUNE 28

Studio Hours: Sun: Store
hours (where store is
open); Mon: Closed; Tue:
Store opening until 5 pm;
Wed-Sat: Store opening un-
til one hour prior to store
closing.

There's more for your life at
SEARS
Celebrating Our 50th Century



- corn for the Duchess of Broughton
who seems depressed after Lord
John's birth.
(SHOW) MOVIE ★★★ "Lost in Amer-
ica" (1985, Comedy) Albert Brooks,
Julia Hagerly.
(TMC) MOVIE ★★★★★ "Harold and
Maude" (1971, Comedy) Ruth Gor-
don, Bud Cort.
1:05 (2) FANTASY ISLAND
(1) BLACK SHEEP SQUADRON After
a captured Navy airman (Kent
McCord) is brainwashed into de-
stroying Marine leaders, he's placed
in Pappy's group.
1:15 (1) MOVIE ★★★ "Take The Mon-
ey And Run" (1969, Comedy) Woody
Allen, Janet Margolin.
SHOW MOVIE ★★ "Bitter Harvest"
(1981, Drama) Rip Howard, Art Car-
ney.
1:30 (1) INDEPENDENT NEWS
(2) THAT GIRL
(3) TOP RANK BOXING Jimmy Navar-
ro vs. Darryl Thigpen in a ban-
terweight bout scheduled for 12
rounds, from Atlantic City, N.J. (R)
(4) BEST OF MONEY, MONEY
(5) CIN MOVIE ★★★ "Grandview,
U.S.A." (1984, Drama) Jamie Lee
Curtis, C. Thomas Howell.
1:45 (2) NIGHTWATCH
2:00 (1) MOVIE ★★★★★ "Cyrano De
Bergacac" (1950, Drama) Jose Fer-
rer, Mala Powers.
(2) LARRY KING OVERNIGHT
(3) MOVIE ★★ "The Night Riders"
(1939, Western) John Wayne,
Doreen McKay.
(4) GET RICH WITH FORECLOSURE
(5) HOLLYWOOD INSIDER
(6) 80'S WOMAN
2:05 (1) NEWS
2:20 (2) DTV
2:30 (1) MOVIE ★★ "Man From
Frisco" (1944, Drama) Michael
O'Shea, Dan Durys.
(2) NEW GENERATION HAIR CARE
(3) TODAY IN WASHINGTON
(4) FAMILY COMPUTING
HBO MOVIE ★★★ "Making 'The
Grade'" (1984, Comedy) Judd Nel-
son, Dana Olsen.
2:40 (SHOW) MOVIE "Model Behav-
ior" (1985, Comedy) Bruce Lyons,
Richard Bekins.
2:45 (TMC) MOVIE ★★★ "I Want
You" (1952, Drama) Dana Andrews,
Dorothy McGuire.
3:00 (1) CROSSFIRE
(2) BREAK THRU TO WEIGHT LOSS
(3) ROOM 222
(4) INVESTMENT ADVISORY
SHOW ANIMALYMPICS Animated.
Gilda Radner and Billy Crystal pro-
vide the voices for various animals
as they prepare for their own Olym-
pic games.
3:10 CN MOVIE ★★★ "Rabbit, Run"
(1970, Drama) James Cagney, An-
jelita Comer.
3:30 (2) SHOWBIZ TODAY
(1) BEVERLY HILLBILLIES
(2) IN SEARCH OF "Indian Astro-
nomers"
(3) GET RICH WITH PENNY STOCKS
(4) CAN YOU BE THINNER?
4:00 (1) ADVENTURES OF BLACK
BEAUTY
(2) DAYBREAK
(3) NEWS

and Don Wilson.

10:30 (1) **NASHVILLE NOW**

(2) **VJ: MARK GOODMAN**

(3) **AUSTRALIAN AFK**

(4) **AUTO RACING** Acropolis Rally, from Athens. (R)

(5) **MAELSTROM** Catherine's curiosity about the mysterious island nearly results in tragedy. (Part 2 of 3)

SHOW MOVIE ★★½ "Lost in America" (1985, Comedy) Albert Brooks, Julie Hagerty.

10:30 (2) **BARNEY MILLER** The financially ailing city plans to save money by closing the precinct.

(3) **WILD AMERICA** A look at the ways a variety of fish adapt to their environment in North American waters. (R)

(4) **BEST OF CARSON** From April 1985: actors Drew Barrymore and Joe Penny and singer Maureen McGovern join host Johnny Carson. In stereo. (R)

(5) **DOCTOR WHO** "The Revenge of the Cybermen" The Doctor returns to the Ark to recover the Tardis but discovers things have changed. (Part 1 of 4)

(6) **QUINCY** Quincy investigates a smuggling ring in Las Vegas after he finds valuable diamonds inside a body.

(7) **MOVIE** ★★★ "They Came to Cordura" (1959, Adventure) Gary Cooper, Rita Hayworth.

(8) **M*A*S*H** Col. Potter is overwhelmed by the attention he receives as his staff tries to reduce his blood pressure before his annual physical.

(9) **BEST OF GROUCHO**

CIN MAXTRAX

10:35 (1) **TAXI** Alex's romantic affair with a beautiful television soap actress leads to thoughts of matrimony.

(2) **WKRP IN CINCINNATI**

(3) **ENTERTAINMENT TONIGHT** Interview with Daniel J. Travanti ("Hill Street Blues").

(4) **BEST OF CARSON** From April 1985: actors Drew Barrymore and Joe Penny and singer Maureen McGovern join host Johnny Carson. In stereo. (R)

(5) **NIGHTLINE**

10:40 (6) **M*A*S*H**

11:00 (7) (11) **MAGNUM, P.I.** Magnum comes to the aid of an innocent

bystander injured while he was pursuing criminal suspects. (R)

(8) **MISTER ED** "Ed's Contact Lenses"

(9) (10) **ANDRE KERTESZ: A POET WITH THE CAMERA** Completed just before his death in 1985 at age 91, this portrait of photojournalism pioneer Andre Kertesz features the artist's reflections on his life and art.

(11) **CROSSFIRE**

(12) **GREAT PERFORMANCES** "Man From Moscow" Wynne goes to Moscow, planning to help Penkovsky get out of Russia before the leak in Soviet security is discovered. (Part 2 of 3) (R) (13) **DOBIE GILLIS**

(14) **BEST OF THE SUPERFEST** Performers include Kool & The Gang, Patti LaBelle, The Mary Jane Girls and The O'Jays for this concert special taped at the Summit in Houston. Host: Lou Rawls.

(15) **ODYSSEY**

(16) **SUPERBOOTS** Sugar Ray Leonard vs. Wilfred Benitez, taped Nov. '79 in Las Vegas, Nev. (R)

(17) **EVERYBODY'S MONEY MATTERS**

(18) **DIANA** Jan is badly wounded as his dangerous mission comes to an end.

HBO MOVIE ★★ "Tomboy" (1984, Comedy) Betsy Russell, Jerry Di-

(TMC) **MOVIE** ★★ "The Sensuous Nureo" (1979, Comedy) Ursula Andress, Dullio Del Prete.

CIN MOVIE ★★ "The Evil That Men Do" (1984, Suspense) Charles Bronson, Theresa Saldana.

11:05 (1) **MAGNUM, P.I.** Magnum comes to the aid of an innocent bystander injured while he was pursuing criminal suspects. (R)

(2) **JEFFERSONS**

(3) **NIGHTLINE**

(4) **700 CLUB**

(5) **(SHOW) MOVIE** ★★½ "Vision Quest" (1985, Drama) Matthew Modine, Linda Fiorentino.

11:10 (6) **MAGNUM, P.I.** Magnum comes to the aid of an innocent bystander injured while he was pursuing criminal suspects. (R)

11:15 (7) **MOVIE** ★★ "Stage Struck" (1957, Drama) Henry Fonda, Susan Strasberg.

11:30 (8) **DONNA REED** Donna fears that the city will cut down her carob tree.

(9) **NEWSNIGHT UPDATE**

(10) **LATE NIGHT WITH DAVID LETTERMAN** Scheduled: comedian John Witherspoon, debutante-author Cornelia Guest. In stereo.

(11) **CAROL BURNETT AND FRIENDS** Skits: Good-Bye Charlie, Soap Opera.

(12) **FATHER KNOWS BEST** Margaret has a problem of conflicting dates when Jim goes to New York and she has a club meeting planned.

(13) **NEW COUNTRY**

(14) **TODAY IN WASHINGTON**

11:35 (15) **ROCKFORD FILES**

(16) **HAWAII FIVE-O** McGarrett fights to save the life of a deepseed gangster whose testimony is needed to convict a crime boss.

(17) **DISNEY CHANNEL PREVIEW**

(18) **ENTERTAINMENT TONIGHT** Interview with Daniel J. Travanti ("Hill Street Blues").

11:40 **SHOW MOVIE** "Model Behavior" (1985, Comedy) Bruce Lyons, Richard Bakula.

12:00 (1) **ISPY**

(2) **OK HEART** Efforts by Wyoming Valley (Pa.) residents to reduce their risk of contracting heart disease through community awareness programs and the establishment of healthful habits. Host: Cliff Robinson.

(3) (12) **INDEPENDENT NEWS**

(4) **700 CLUB**

(5) **ADVENTURES OF OZZIE & HARRIET** "Ozzie Keeps A Secret" Ozzie finds out that Ricky isn't very good at keeping secrets when he makes plans to get Ricky's girlfriend to a surprise birthday party in her honor.

(6) **FIRE ON THE MOUNTAIN**

(7) **ALFRED HITCHCOCK HOUR**

(8) **VJ: J.J. JACKSON** J.J. Jackson and the Japanese Experience

(9) **SPORTSLOOK**

(10) **ONE BY ONE** "Of Babes And Sucklings" Turner discovers the whereabouts of a circus act he abandoned baby orangutans in Britain.

12:05 (11) **LATE NIGHT WITH DAVID LETTERMAN** Scheduled: comedian John Witherspoon, debutante-author Cornelia Guest. In stereo.

(12) **JIMMY SWAGART**

12:10 (13) (11) **MOVIE** ★★ "Catherine" (1988, Comedy) Peter Onorati, Joanne Moresau.

12:15 (14) **MOVIE** ★★ "Great Catherine" (1988, Comedy) Peter Onorati, Joanne Moresau.

12:20 (15) **MOVIE** ★★ "Great Catherine" (1988, Comedy) Peter Onorati, Joanne Moresau.

12:30 (16) **SPORTS LATE NIGHT**

(17) **NEWS**

(18) **MOVIE** ★★ "The Eagle's Wing" (1979, Western) Martin Sheen, Sam Waterston.

(19) **DANCIN' USA**

(20) **SPORTSCENTER**

HBO WIMBLEDON TENNIS Highlights of the day's matches.

CIN CRAZY ABOUT THE MOVIES: STEVE MCQUEEN Film clips from "Bullitt" and "The Sand Pebbles" as well as television footage and interviews with friends, family and co-workers including his first wife, Nellie McDuen, Chuck Norris, Keri Malden, Shelby Winters and directors Robert Wise and Norman Jewison, are featured in this look at the life of Steve McQueen.

12:35 (21) **BENNY HILL**

12:55 **HBO MOVIE** ★★ "Everything You Always Wanted To Know About Sex (But Were Afraid To Ask)" (1972, Comedy) Woody Allen, Gene Wilder.

1:00 (22) **ROUTE 68** A 9-year-old orphan asks Buzz and Tod for help when her alcoholic guardian (Dan Duryea) is called into court.

(23) **NEWS OVERNIGHT**

(24) **COMEDY BREAK**

(25) **MOVIE** ★½ "Heartaches" (1947, Drama) Sheila Ryan, Edward Norris.

(26) **BEST OF MONEY, MONEY**

(27) **EDGE OF NIGHT**

(28) **INSIDE BASEBALL**

(29) **MAKING MONEY WITH CAROL**

(30) **NANNY** Barbara expresses her



1:15 a.m. (Tuesday) (WTBS) Take the Money and Run Woody Allen's first effort as writer/director/star was a comic success, as he parades a non-stop chain of jokes and sight gags involving the story of a compulsive criminal. Allen's use of a documentary style began here, and was refined in his later films. A favorite gag: Allen and a troupe of escaped road-gang convicts, all chained together, trying to ride a bicycle down a country lane.

Monday

SEARS PORTRAIT STUDIO

We Bring Out the Best in Babies!

9⁹⁵
18-piece
portrait collection
plus 95' sitting fee

3-5x7s and 15 wallets on your
choice of a traditional, nursery,
spring or fall background

At Sears, no appointment is ever
necessary to get professional quality
photographic portraits. We welcome
adults and family groups. Each
additional person is only 95¢.
POSES OUR SELECTION. These
attractive options available in addition
to this offer: White Background,
Black Background and Double
Feature Portraits. Use your
Sears Credit Card!

Also available: Instant Color Passport
Photos, Copy & Restoration.

**OFFER FOR PORTRAITS
TAKEN THRU JUNE 28**

Studio Hours: Sun: Store
hours (where store is
open); Mon: Closed; Tue:
Store opening until 5 pm;
Wed-Sat: Store opening until
one hour prior to store
closing.

There's more for your life at
SEARS
Celebrating Our New Century



- cern for the Duchess of Broughton who seems depressed after Lord John's birth.
- (SHOW) MOVIE ★★★** "Lost in America" (1985, Comedy) Albert Brooks, Julie Hagerty.
- (TMC) MOVIE ★★★★★** "Harold and Maude" (1971, Comedy) Ruth Gordon, Bud Cort.
- 1:06 (F) FANTASY ISLAND**
- (Z) BLACK SHEEP SQUADRON** After a captured Navy airman (Kent McCord) is brainwashed into destroying Marine leaders, he's placed in Pappy's group.
- 1:16 (Z) MOVIE ★★★** "Take The Money And Run" (1969, Comedy) Woody Allen, Janet Margolin.
- SHOW MOVIE ★★** "Bitter Harvest" (1981, Drama) Rip Howard, Art Carney.
- 1:30 (I) INDEPENDENT NEWS**
- (Z) THAT GUY!**
- (Z) TOP RANK BOXING** Jimmy Navarro, vs. Danny Thigpen in a bantamweight bout scheduled for 12 rounds, from Atlantic City, N.J. (R)
- (Z) BEST OF MONEY, MONEY**
- CIN MOVIE ★★★** "Grandview, U.S.A." (1984, Drama) Jamie Lee Curtis, C. Thomas Howell.
- 1:45 (Z) NIGHTWATCH**
- 2:00 (Z) MOVIE ★★★★★** "Cyrano De Bergerac" (1950, Drama) José Ferrer, Malá Powers.
- (Z) LARRY KING OVERNIGHT**
- (Z) MOVIE ★★** "The Night Riders" (1939, Western) John Wayne, Doreen McKay.
- (Z) GET RICH WITH FORECLOSURE**
- (Z) HOLLYWOOD INSIDER**
- (Z) BOY'S WOMAN**
- 2:05 (Z) NEWS**
- 2:20 (Z) DTV**
- 2:30 (Z) MOVIE ★★** "Man From Frisco" (1944, Drama) Michael O'Shea, Dan Duryea.
- (Z) NEW GENERATION HAIR CARE**
- (Z) TODAY IN WASHINGTON**
- (Z) FAMILY COMPUTING**
- HBO MOVIE ★★★** "Making The Grade" (1984, Comedy) Judd Nelson, Dana Olsen.
- 2:40 (SHOW) MOVIE** "Model Behavior" (1985, Comedy) Bruce Lyons, Richard Bekins.
- 2:45 (TMC) MOVIE ★★★** "I Want You" (1952, Drama) Dana Andrews, Dorothy McGuire.
- 3:00 (Z) CROSSFIRE**
- (Z) BREAK THRU TO WEIGHT LOSS**
- (Z) ROOM 222**
- (Z) INVESTMENT ADVISORY**
- SHOW ANIMALYMPICS** Animated. Gilde Radner and Billy Crystal provide the voices for various animals as they prepare for their own Olympic games.
- 3:10 CIN MOVIE ★★★** "Rabbit, Run" (1970, Drama) James Caan, Anjanette Comer.
- 3:30 (Z) SHOWBIZ TODAY**
- (Z) BEVERLY HILLBILLIES**
- (Z) IN SEARCH OF...** "Indian Astronomers"
- (Z) GET RICH WITH PENNY STOCKS**
- (Z) CAN YOU BE THINNER?**
- 4:00 (Z) ADVENTURES OF BLACK BEAUTY**
- (Z) DAYBREAK**
- (Z) NEWS**



Tuesday evening programs

- 6:00 (2) (3) (6) (7) (11) (12) (2) (11)
NEWS
 (1) MY THREE SONS
 (2) BUSINESS REPORT
 (3) WHEEL OF FORTUNE
 (4) PRIMENEWS
 (5) WILD, WILD WORLD OF ANI-

MAIS This is a portrayal of the lives of wild slothpunks which are captured and then trained.
 (3) **TEEN MAGAZINE: THE GREAT MODEL SEARCH** From the Palace Theatre in Los Angeles, this magazine style program features profile

segments of 12 finalists of whom the winner receives two modeling contracts, a car and a chance to embark on a modeling career. Hosted by Justice and Jason Bateman.

(2) (12) **WKRP IN CINCINNATI** Mr. Carlson and Jennifer take over Herb's job during his hospitalization.
 (1) **DAKTARI** When Judy pitches in to help some natives, things turn up missing from the compound, including animals.

Daytime movies

- 5:00 (2) ***½ "Mary White" (1977, Drama) Ed Flanders, Kathleen Bellor. (TMC) *** "Our Very Own" (1950, Drama) Ann Blyth, Farley Granger.
 6:00 SHOW ***½ "Fletch" (1985, Comedy) Chevy Chase, Joe Don Baker.
 7:00 (TMC) *** "The Return Of Martin Guerre" (1981, Drama) Gerard Depardieu, Nathalie Baye. (CIN) *** "All Of Me" (1984, Comedy) Steve Martin, Lily Tomlin.
 8:00 (2) *** "Man Are Not Gods" (1937, Drama) Rex Harrison, Miriam Hopkins. SHOW ** "The Gang That Couldn't Shoot Straight" (1971, Comedy) Jerry Orbach, Leigh Taylor-Young.
 8:06 (2) *** "Thru Ring Circus" (1954, Comedy) Dean Martin, Jerry Lewis.
 8:30 CIN *** "Auntie Mame" (1958, Comedy) Rosalind Russell, Roger Smith.
 9:00 HBO *** "Airplane!" (1980, Comedy) Robert Hays, Julie Hagerty. (SHOW) ***½ "Fletch" (1985, Comedy) Chevy Chase, Joe Don Baker. (TMC) ***½ "Escape From El Diablo" (1983, Adventure) Jimmy McNichol, Timothy Van Patton.
 10:00 SHOW ***½ "Protocol" (1984, Comedy) Goldie Hawn, Chris Sarandon.
 10:30 (2) ** "Trail Of Danger" (1978, Western) Jim Davis, Larry Wilcox. HBO ** "Windwalker" (1984, Drama) Trevor Howard, Nick Ramus. (TMC) ***½ "F.I.S.T." (1978, Drama) Sylvester Stallone, Peter Boyle.
 11:00 (2) ** "Durango Valley Raiders" (1938, Western) Bob Steele. (SHOW) ** "The Gang That Couldn't Shoot Straight" (1971, Comedy) Jerry Orbach, Leigh Taylor-Young. CIN ***½ "The Karate Kid" (1984, Drama) Ralph Macchio, Noriyuki "Pat" Morita.
 11:05 (2) ***½ "Jivaro" (1954, Adven-

- ture) Fernando Lamas, Rhonda Fleming.
 12:00 SHOW ***½ "Careful, Ho Might Hear You" (1983, Drama) Wendy Hughes, Robyn Nevin.
 1:00 (2) ***½ "Mary White" (1977, Drama) Ed Flanders, Kathleen Bellor. HBO ***½ "Joey" (1985, Drama) Nail Barry, James Quinn. (SHOW) ***½ "Protocol" (1984, Comedy) Goldie Hawn, Chris Sarandon. (TMC) *** "Our Very Own" (1950, Drama) Ann Blyth, Farley Granger.
 1:15 CIN *** "Wuthering Heights" (1939, Romance) Laurence Olivier, Merle Oberon.
 2:00 (2) *** "The Pony Princess" (1953, Comedy) Dirk Bogarde, Yolande Donlan. (2) "Glass Babies" (1985, Drama) (Part 2 of 2) Belinda Davoy, Gary Day.
 2:30 SHOW ** "No Big Deal" (1983, Drama) Tommy Grimes, Kevin Dillon.
 3:00 (2) ***½ "A Run For Your Money" (1940, Comedy) Alec Guinness, Donald Houston. (SHOW) ***½ "Careful, Ho Might Hear You" (1983, Drama) Wendy Hughes, Robyn Nevin. (TMC) ** "Rhinestone" (1984, Comedy) Sylvester Stallone, Dolly Parton. CIN ***½ "Fire On The Mountain" (1981, Drama) Ron Howard, Buddy Ebsen.
 4:00 HBO *** "Hans Christian Anderson" (1952, Musical) Danny Kaye, Jeanmarie. SHOW ***½ "Fletch" (1985, Comedy) Chevy Chase, Joe Don Baker.
 5:00 (TMC) *** "The Return Of Martin Guerre" (1981, Drama) Gerard Depardieu, Nathalie Baye.
 5:30 (SHOW) ** "No Big Deal" (1983, Drama) Tommy Grimes, Kevin Dillon. CIN *** "Rachel And The Stranger" (1948, Drama) Loretta Young, William Holden.

- (2) **NASHVILLE NOW**
 (2) **CHAIN REACTION**
 (2) **ENTERTAINMENT TONIGHT** Interview with Aretha Franklin.
 (2) **A FEELING FOR FRANCE**
 (2) **CONGRESSIONAL HEARING**
 (2) **ROLLER DERBY**
 (2) **PARTNERS IN CRIME**
 (2) **BACHESTER CHRONICLES** Reverend Harding is accused of swindling in Trollope's comedy of manners starring Donald Pleasence. (Part 1 of 7)
 HBO **WIMBLEDON TENNIS** Same-day early round coverage from London.
 SHOW MOVIE ***½ "Protocol" (1984, Comedy) Goldie Hawn, Chris Sarandon.
 6:30 (2) (3) (11) **WHEEL OF FORTUNE**
 (3) **MISTER ED** "Ed's Cold Tail"
 (3) **WILD AMERICA** An exploration of America's wildlife refuges, from the smallest in Florida to the largest in Alaska. (2) **JEOPARDY**
 (2) **BENSON** Benson is involved in Katie's cookie business at the same time he is to testify against the mob.
 (2) **ALICE** Alice's moonlighting as a singer is making her tardy and tired at the diner.
 (2) **BUSINESS REPORT**
 (3) **M*A*S*H** The 4077th becomes an impromptu orphanage when heavy shelling forces Korean children to seek shelter at the camp.
 (2) (12) **NEWLYWED GAME**
 (2) **DONALD DUCK PRESENTS**
 (2) **ALL-STAR BLITZ**
 (2) **PM MAGAZINE** The creator of the Utah Homefront Gallery catalogue; big-money contest winners.
 (3) **\$100,000 PYRAMID**
 (2) **PRIME TIME ACCESS**
 7:00 (2) (3) (2) (11) **SIAMON & SIMON** The brothers pose as camp counselors to investigate the alleged criminal goings-on at a youth camp. (R)

Daytime sports

- 6:30 (2) **SPORTSCENTER**
 7:00 (2) **INSIDE BASEBALL**
 7:30 (2) **PGA SENIORS GOLF** Tournament Players Championship, second round, from Cleveland. (R)
 8:30 (2) **SPORTSLOOK**
 11:00 (2) **AUTO RACING Formula One** Canadian Grand Prix, from Circuit Gilles Villeneuve on Ile de Notre Dame in Montreal. (R)
 12:30 (2) **DIVING** McDonald's International Invitational, from Fort Lauderdale, Fla. (R)

- 2:00 (2) **AUSTRALIAN RULES FOOTBALL**
 3:00 (2) **FISHIN' HOLE**
 4:00 (2) **SPORTSLOOK**
 4:30 (2) **WORLD CLASS WOMEN**
 5:00 (2) **SPORTSCENTER**
 6:30 (2) **BASEBALL** Chicago Cubs at Philadelphia Phillies (Live)
 (2) **AUTO RACING SPECIAL: MICHELLE MOUTON EXPLAINS RALLY RACING**

50% OFF MINI BLINDS
Ramsey's
DRAPERY & INTERIORS
 236 MAIN AVE. N. 733-1979

TUESDAY EVENING

| | 7:00 | 7:30 | 8:00 | 8:30 | 9:00 | 9:30 | 10:00 | 10:30 | 11:00 | 11:30 | 12:00 | 12:30 |
|------|-------------------------|----------|--|------|-------------------------------------|------|----------|------------|------------------|-----------------|-----------------|-----------|
| 2 | Simon & Simon | | Magnum, P.I. | | Equalizer | | News | B. Miller | Simon & Simon | | Movie | |
| 4 | MacNeil / Lehrer | | News | | Frontline | | Am. Int. | Adam Smith | | | | |
| 6 | Bosch | G. Pains | Moonlighting | | Sponsor: For Hire | | News | Entertain. | Nightline | Hawaii Five-O | | |
| 7 | A-Team | | Hunter | | 1988 | | News | Tonight | | David Letterman | | News |
| 9 | Star Trek | | Movie: "Harry And Walter Go To New York" | | | | | Quincy | | C. Burnett | | Ind. News |
| 12 | Simon & Simon | | Magnum, P.I. | | Equalizer | | News | M*A*S*H | Simon & Simon | | Movie | |
| SHOW | Movie: "Fletch" | | | | Movie: "Protocol" | | | | Paper Chase | | Movie | |
| SHOW | Movie Cont'd | | Paper Chase | | Movie: "Careful, He Might Hear You" | | | | D.C. Beach Party | | Movie: "Border" | |
| HBO | Wimbledon Tennis Cont'd | | Wimbled. | | Movie: "Conan The Destroyer" | | | | Philp Markowe | | Not News | Wimbled. |

Tuesday

- 3** I SPY
10 MACNEIL / LEHRER NEWS HOUR
4 **7** **9** WHO'S THE BOSS? In America for a prearranged wedding. Tony's cousin is taken on a shopping spree by Angela. (R) □
5 LARRY KING LIVE
7 **9** **12** A-TEAM While auditioning for a role on a children's TV show, Hannibal discovers that the star is the target of mobsters. In stereo. (R) □
7 NOVA A survey of climate predictions and hazard warnings for the next century, based on the "greenhouse" effect of soaring fossil fuel consumption. (R) □
8 MOVIE ★★½ "The Blue Knight" (1975, Adventure) George Kennedy, Alex Rocco.
9 (12) STAR TREK Kirk must find the antidote to a plague that threatens to kill all the crew of the Enterprise.
11 700 CLUB
13 MOVIE ★★½ "The Invincible Boy" (1957, Science-Fiction) Philip Abbott, Richard Eyer.
15 CARTOONS
17 V.J. MARK GOODMAN
20 PORTRAITS OF POWER
21 WRESTLING
22 REGIS PHILBIN'S LIFESTYLES
23 STAGE: DRUNKARD Tom Bosley stars as Lawyer Cribbe in this musical melodrama featuring hearty sing-alongs and "required" audience participation. Music composed by Barry Manilow.
(SHOW) MOVIE ★★½ "Fletch" (1985, Comedy) Chevy Chase, Joe Don Baker.
(TMC) MOVIE ★★½ "F.I.S.T." (1978, Drama) Sylvester Stallone, Peter Boyle.
CIN MOVIE ★★½ "The Flamingo Kid" (1984, Comedy) Matt Dillon, Richard Crenna.
7:30 **7** **9** **12** GROWING PAINS Mike disobeys his parents and takes off on a wild-and-wooly ride on a dirt bike. (R) □
10 NEW COUNTRY
20 BEST KEPT SECRETS
21 VIEWER CALL-IN
8:00 **7** **9** **12** (11) MAGNUM, P.I.
1 ROUTE 66 Tod and Buz become involved with a ruthless New Mexico rancher and his widowed pregnant Indian daughter-in-law. Guest stars: Robert Davall, Delver Pyle.
10 **12** NOVA A survey of climate predictions and hazard warnings for the

next century, based on the "greenhouse" effect of soaring fossil fuel consumption. (R) □

4 **7** **9** MOONLIGHTING Maddie and David's involvement with a collection agency leads them into an international escapade. (R) □
5 NEWS
7 **9** **12** HUNTER A mad bomber returns to the city and hatches a plan for revenge against Hunter. In stereo. (R) □
7 FRONTLINE A look at how many families are coping with the emotional and financial dilemmas posed by the burgeoning over-75 age group whose life's savings have been eroded by the high cost of living. (R) □

(12) MOVIE ★★ "Harry And Walter Go To New York" (1978, Comedy) Elliott Gould, James Caan.
13 CROOK AND CHASE
15 RADIO 1990
17 GUEST V.J.S: MITCH GAYLORD AND JANET JONES.
20 DIAMONDS IN THE SKY
21 DR. RUTH SHOW
SHOW PAPER CHASE When Rita Harriman suffers two setbacks, losing her boyfriend and having her law review article rejected by Kingfield, she turns to Hart for comforting.

8:30 **9** BASEBALL Atlanta Braves at Los Angeles Dodgers (Live)
11 NEWS
11 CELEBRITY CHEFS Guests: Bob-bey Baro and Eartha Kitt.
15 MOUSETRAPPIECE THEATER
17 VIDEOCOUNTRY
19 WILD, WILD WORLD OF ANIMALS
20 TODAY IN WASHINGTON
HBO WIMBLEDON TENNIS Highlights of the day's matches.
9:00 **7** **9** **12** (11) EQUALIZER McCall is framed for the murder of two thugs; a college student is threatened by a group of rowdies. (R) □
11 MOVIE ★★ "The Stork Club" (1945, Musical) Betty Hutton, Barry Fitzgerald.
13 **16** FRONTLINE A look at how many families are coping with the emotional and financial dilemmas posed by the burgeoning over-75 age group whose life's savings have been eroded by the high cost of living. (R) □
17 **19** **21** SPENSER: FOR HIRE A deaf-mute columnist turns to Spenser for help in finding a reader with whom she has fallen in love. (R) □
21 MONEYLINE

- 1** **11** **12** 1986
7 CIVIC DIALOGUE
11 BILL COSBY
12 SWAMP FOX "A Woman's Court-ship"

10 YOU CAN BE A STAR
12 MOVIE ★★½ "M Station: Hawaii" (1980, Adventure) Jared Martin, Jo Ann Harris.

11 V.J. MARK GOODMAN
20 PERSPECTIVE

21 INSIDE THE PGA TOUR
19 MOVIE "Body Business" (1983, Drama) (Part 2 of 2) Jane Menolaus, Carmen Duncan.

21 I AM THE BLUES Singer-guitarist Willie Dixon is the star of this performance documentary including an appearance by "Baby Doo" Canton and his Chicago All-Stars.
HBO MOVIE ★★ (Adventure) Arnold Schwarzenegger, Grace Jones.
(SHOW) MOVIE ★★½ "Protocol" (1984, Comedy) Goldie Hawn, Chris Sarandon.

SHOW MOVIE ★★½ "Careful, He Might Hear You" (1983, Drama) Wendy Hughes, Robyn Navin.
CIN MOVIE ★★½ "The Karate Kid" (1984, Drama) Ralph Macchio, Nori-yuki "Pat" Morita.

9:30 **12** SPORTS TONIGHT
7 I REMEMBER GORGEOUS GEORGE
9 TRAPPER JOHN, M.D.

11 BURNS AND ALLEN Wanting to improve her IQ, Gracie decides to take Spanish lessons.

15 FANDANGO
20 LIVING TOMORROW
21 SPORTSCENTER
(TMC) MOVIE ★★ "Rhinestone" (1984, Comedy) Sylvester Stallone, Dolly Parton.

10:00 **7** **9** **11** **12** (11) NEWS

10 AMERICAN INTERESTS

12 NEWSNIGHT

7 NOT THE NINE O'CLOCK NEWS
11 JACK BENNY Jack imagines himself a Western hero.

15 RETURN TO TREASURE ISLAND "Treasure Island" Long John Silver rescues Jim from Garcia and they set sail with Van Der Brecken for Treasure Island.

17 NASHVILLE NOW

20 DIMENSIONS IN SCIENCE

21 TOP RANK BOXING Jimmy Nevar-

Tuesday

ro vs. Darryl Thigpen in a banterweight bout scheduled for 12 terms, from Atlantic City, N.J. (R)

10:00 **BARCHESTER CHRONICLES** Reverend Harding is accused of swindling in Trollope's comedy of manners starring Donald Pleasence. (Part 1 of 7)

10:30 **BARNEY MILLER** A sniper fires on Wojo who complains of being a target right outside the precinct.

11:00 **ADAM SMITH IN THE NEW CHINA: FROM MARX TO MASTERCARD?** This on-location survey of the trend toward free enterprise features conversations with a factory manager, a farmer, the owner of a fast-food stand, and the mayor of Shanghai. (R)

11:00 **TONIGHT** Host: Johnny Carson. Scheduled: Joe Garagiola, Paul Provenza, actor Anthony Perkins. In stereo.

11:00 **DOCTOR WHO** "The Revenge Of The Cybermen" Sarah is infected by the venom from a cyberman. (Part 2 of 4)

11:00 **QUINCY**

11:00 **MOVIE** ★★ "Gold" (1974, Adventure) Roger Moore, Susanah York.

11:00 (11) **M*A*S*H** Hawkeye is overcome by a mysterious bout of non-stop sneezing.

11:00 **BEST OF GROUCHO**

11:00 **PLANET OF MAN**

11:35 **TAXI** Latka decides to return to his native country to fight in a revolution.

11:40 **WKRP IN CINCINNATI**

11:40 **ENTERTAINMENT TONIGHT** Interview with Aretha Franklin.

11:40 **TONIGHT** Host: Johnny Carson. Scheduled: Joe Garagiola, Paul Provenza, actor Anthony Perkins. In stereo.

11:40 **NIGHTLINE**

12:00 **M*A*S*H**

12:00 (11) **SIMON & SIMON A.J.**, Rick and Downtown Brown try to clear an undercover cop framed for the murders of two fellow officers. (R)

12:00 **MISTER ED** "Ed's Cold Tail"

12:00 **CROSSFIRE**

12:00 **AMERICAN MASTERS** "Private Conversations: On the Set of 'Death of a Salesman'" (Premiere) Host: Joanne Woodward examines American art and artists beginning with a behind-the-scenes look of how the Broadway production of "Death of a Salesman" was adapted for TV. Playwright Arthur Miller and actor Dustin Hoffman are featured. (R)

12:00 **DOBIE GILLIS**

12:00 **JEAN SHEPHERD'S THE GREAT AMERICAN FURTH OF JULY AND OTHER DISASTERS** Matt Dillon stars in humorist Jean Shepherd's look at growing up in America during the 40's and 50's.

12:00 **DICK CAVETT** Guests: Loo Grant, Malcolm Forbes.

12:00 **CHRONICLE**

12:00 **EVERYBODY'S MONEY MATTERS**

12:00 **STAGE: DRUNKARD** Tom Bosley stars as Lawyer Cribbs in this musical melodrama featuring hearty sing-alongs and "required" audience participation. Music composed by Barry

Manilow.

HBO PHILIP MARLOWE, PRIVATE EYE Marlowe is the prime suspect when a hood he was hired to body-guard is found dead. (R)

(SHOW) **PAPER CHASE** When Rita Harrison suffers two setbacks, losing her boyfriend and having her law review article rejected by Kingsfield, she turns to Hari for comforting.

11:05 **SIMON & SIMON A.J.**, Rick and Downtown Brown try to clear an undercover cop framed for the murders of two fellow officers. (R)

11:05 **JEFFERSONS**

11:05 **NIGHTLINE**

11:05 **700 CLUB**

11:05 **SHOW D.C. BEACH PARTY: A MUSICAL CELEBRATION** A tribute to the 100th anniversary of the Washington Monument featuring the Beach Boys, Julio Iglesias and Ringo Starr. In stereo.

11:10 **SIMON & SIMON A.J.**, Rick and Downtown Brown try to clear an undercover cop framed for the murders of two fellow officers. (R)

11:15 **MOVIE** ★★ "Crosswinds" (1951, Adventure) John Payne, Rhonda Fleming.

11:15 **CIN MOVIE** ★★ "The Wild Life" (1984, Comedy) Christopher Penn, Eric Stoltz.

11:30 **DONNA REED** A young man can't cope with the rigors of college.

11:30 **NEWSNIGHT UPDATE**

11:30 **LATE NIGHT WITH DAVID LETTERMAN** Scheduled: comedian Bill Dana; stupid pet tricks. In stereo.

11:30 (12) **CAROL BURNETT AND FRIENDS** Skits: The Business Lunch, The Vending Machine, The Butcher Shop.

11:30 **FATHER KNOWS BEST** Bud has problems deciding between two beautiful girls that he wants to date.

11:30 **NEW COUNTRY**

11:30 **TODAY IN WASHINGTON**

11:30 **FISHING: JOHN FOX'S OUTDOOR ADVENTURES**

(TMC) **MOVIE** ★★ "Alphabet City" (1984, Drama) Vincent Spano, Kate Vernon.

11:35 **ROCKFORD FILES**

11:35 **HAWAII FIVE-O** A lover's quarrel ends in death and McGarrett's only clues are a circular mark and a large footprint.

11:35 **ENTERTAINMENT TONIGHT** Interview with Aretha Franklin.

12:00 **ISPY**

12:00 (12) **INDEPENDENT NEWS**

12:00 **700 CLUB**

12:00 **ADVENTURES OF OZZIE & HARRIET** "David's Car Payments" Ozzie and Harriet become concerned when an overdue car payment notice arrives for David.

12:00 **FIRE ON THE MOUNTAIN**

12:00 **ALFRED HITCHCOCK HOUR**

12:00 V.J. JACKSON

12:00 **ISLAND WILDLIFE**

12:00 **SPORTSLOOK**

HBO NOT NECESSARILY THE NEWS Comedy sketches combine with classic film and news footage in an offbeat, satiric take-off.

(SHOW) **MOVIE** ★★ "Careful, He Might Hear You" (1983, Drama) Wendy Hughes, Robyn Nevlin.

12:05 **LATE NIGHT WITH DAVID LETTERMAN** Scheduled: comedian Bill Dana; stupid pet tricks. In stereo.

12:05 **JIMMY SWAGGART**

12:10 (11) **MOVIE** ★★ "Beyond

Reason" (1978, Drama) Telly Savalas, Diana Muldaur.

12:15 **MOVIE** ★★ "Beyond Reason" (1978, Drama) Telly Savalas, Diana Muldaur.

12:20 **MOVIE** ★★ "Beyond Reason" (1978, Drama) Telly Savalas, Diana Muldaur.

12:30 **SPORTS LATE NIGHT**

12:30 **NEWS**

12:30 **MOVIE** ★★ "Agent B 3" (1985, Comedy) Dirk Bogarde, Sylvia Koscina.

12:30 **DANCIN' USA**

12:30 **SPORTSCENTER**

12:30 **HBO WIMBLEDON TENNIS** Highlights of the day's matches.

12:35 **DAY HILL**

12:55 **HBO BOB DYLAN IN CONCERT** Taped in Sydney, Australia in February 1966, this concert chronicles the truest side of the folk singer on his True Confessions Tour. Backed by Tom Petty and the Heartbreakers, he performs songs both live-recorded set "Biograph."

12:55 **CIN MOVIE** ★★ "Into the Night" (1984, Drama) Jeff Goldblum, Michelle Pfeiffer.

1:00 **ROUTE 66** Tod and Buz become involved with a ruthless New Mexico rancher and his widowed pregnant Indian daughter-in-law. Guest stars: Robert Duvall, Denver Pyle.

1:00 **NEWS OVERNIGHT**

1:00 **COMEDY BREAK**

1:00 **MOVIE** ★★ "The Magnificent Rogue" (1946, Comedy) Warren Douglas, Lynne Roberts.

1:00 **A MILLIONAIRE'S SECRET TO WEALTH**

1:00 **EDGE OF NIGHT**

1:00 **KARATEMANIA: THE BATTLE OF ATLANTA**

1:00 **GET RICH WITH PENNYSTOCKS**

1:00 **I AM THE BLUES** Singer-guitarist Willie Dixon is the star of this performance documentary including an appearance by "Baby Doe" Caslon and his Chicago All-Stars. (TMC) **MOVIE** ★★ "Porky's" (1981, Comedy) Dan Monahan, Mark Herlihy.

1:05 **FANTASY ISLAND**

1:05 **AT THE MOVIES** Scheduled reviews: "Lopaz Eagles" (Robert Redford, Dobra Winger, Daryl Hannah); "Desert Hearts" (Helen Shaver, Patricia Charbonneau); "Spring Symphony" (Nastassja Kinski).

1:15 **MOVIE** ★★ "Alcatraz Express" (1960, Drama) Robert Stack, Neville Brand.

1:30 **INDEPENDENT NEWS**

1:30 **THAT GIRL**

1:35 **IN SEARCH OF...** "Butch Cassidy"

1:45 **NIGHTWATCH**

2:00 **MOVIE** ★★ "The Stork Club" (1945, Musical) Betty Hutton, Barry Fitzgerald.

2:00 **LARRY KING OVERNIGHT**

2:00 **MOVIE** ★★ "Twenty-Three Paces To Baker Street" (1956, Mystery) Van Johnson, Vera Miles.

2:00 **BREAK THRU TO WEIGHT LOSS**

2:00 **WRESTLING**

HBO MOVIE ★★ "Blood Simple" (1984, Drama) John Getz, Frances McDormand.

- 05 (3) NEWS
 (1) SCHEME OF THINGS
 (SHOW) D.C. BEACH PARTY: A MUSICAL CELEBRATION A tribute to the 100th anniversary of the Washington Monument featuring the Beach Boys, Julio Iglesias and Ringo Starr. In stereo.
 SHOW MOVIE ★★ "Children of The Corn" (1984, Horror) Peter Horton, Linda Hamilton.
 (30) MOVIE ★★ "Young And Dangerous" (1957, Drama) Mark Damon, Connie Stevens.
 (25) TODAY IN WASHINGTON
 40 (4) MORE
 45 (TMC) MOVIE ★★ "F.I.S.T." (1978, Drama) Sylvester Stallone, Peter Boyle.
 55 CIN MOVIE ★★ "Lovescones" (1984, Adult) Franco Luz, Tiffany Bolling.
 5:00 (2) CROSSFIRE
 (5) SUCCESS STRATEGIES FOR

- WOMEN
 (1) BOWLING American Bowling Congress Bud Light Masters Tournament, from Las Vegas. (R)
 (1) SUCCESS IS NOT AN ACCIDENT
 3:10 (4) WORLD AT LARGE
 (SHOW) MOVIE ★★ "The Border" (1981, Drama) Jack Nicholson, Valerie Perrine.
 3:30 (5) SHOWBIZ TODAY
 (1) BEVERLY HILLBILLIES
 3:40 SHOW PAPER CHASE When Rita Harriman suffers two setbacks, losing her boyfriend and having her law review article rejected by Kingsfield, she turns to Hart for comfort.
 3:45 HBO MOVIE ★★ "Lost In America" (1985, Comedy) Albert Brooks, Julia Hagerty.
 4:00 (2) ADVENTURES OF BLACK BEAUTY
 (5) DAYBREAK
 (2) NEWS
 (1) JIMMY SWAGGART

- (1) 60 MINUTES TO SUCCESS
 (1) BEST OF THE SUPERBEST Performers include Kool & The Gang, Patii LaBelle, The Mary Jane Girls and The O'Jays for this concert special taped at the Summit in Houston. Host: Lou Rawls. (R)
 (1) VJ: NINA BLACKWOOD
 (1) AEROBICS: BODIES IN MOTION
 (1) VICTORY OVER IRS
 4:30 (2) NICK ROCKS: VIDEO TO GO
 (5) BUSINESS MORNING
 (3) FUNTIME
 (7) FAITH 20
 (1) HONEY, HONEY
 (1) NATION'S BUSINESS TODAY
 CIN MOVIE ★★ "The Wild Life" (1984, Comedy) Christopher Penn, Eric Stolz.

Justice Department provided NBC interview with terrorist

By FRED ROTHENBERG
 The Associated Press

LOS ANGELES — NBC News has allowed the Justice Department to view the interview the network held with terrorist Abul Abbas, including portions of the interview that are not being aired, NBC News president Lawrence K. Grossman said Monday.

Grossman said the network is planning to give the department a copy of the videotape of the interview with Abbas, the Palestinian accused of plotting the Achille Lauro hijacking in which American Leon Klinghoffer was slain.

Portions of the interview were broadcast May 5 on "NBC Nightly News."

The Justice Department, which is conducting a criminal investigation of Abbas, reportedly engaged in negotiations with NBC last month in an attempt to persuade the network to turn over unused videotape from the Abbas interview.

Justice was especially interested in the fact that on the May 5 broadcast, NBC News correspondent Henry Champ said Abbas "freely admits responsibility for the hijacking of the Italian cruise ship, the Achille Lauro." However, no videotape was shown of any such remark by Abbas and federal criminal lawyers would like to know whether it exists.

Champ agreed not to disclose Abbas' whereabouts as a condition for the meeting.

In the negotiations, Justice Department officials hoped to persuade NBC to provide the material

without having to issue a subpoena, thus avoiding a furor over the case, sources in Washington told The Associated Press.

Grossman on Monday said the network "recently" allowed Justice officials to review videotapes and transcripts of the interview with Abbas. He declined to be more specific about when the review took place.

He said the review took place on NBC premises, but no transcripts or tapes had yet been turned over to the department.

"We are planning to turn over at the request of the Justice Department the videotape of the interview," Grossman said in an interview. "They have already seen the transcripts and have screened the interview."

The day after the portions of the interview was broadcast, the State Department accused NBC of encouraging terrorism.

Robert Oakley, head of the department's counterterrorism section, suggested that when news

media make deals to interview terrorist fugitives the news organizations become "accomplices." He called the interview "reprehensible."

In an earlier interview with television reporters, Grossman defended the interview. "We're not in the job of capturing fugitives; we're in the job of reporting the news."

Grossman was asked several times whether NBC News had an obligation to bring Abbas to justice.

"We're not an intelligence service or law enforcement agency," Grossman said. "Our role is to report the news."

Grossman said the British news agency Reuters and the Irish Times newspaper also interviewed Abbas without disclosing his location. Neither story had a dateline.

The news executive said the value of the Abbas broadcasts was for "the American people to see for themselves what kinds of threats there are, and to see for themselves who the people making (the threats) are..."

**REMODELING
&
NEW CONSTRUCTION**

- Kitchens
- Baths
- Basements
- Homes

- Free Estimates
- Guaranteed Work
- Insurance Work
- Free Clean-Up

RENFRO CONSTRUCTION CO.

Buhl, Idaho "Serving All The Magic Valley" 543-8477



Wednesday evening programs

- 6:00 **NEWS**
3 MY THREE SONS
7 BUSINESS REPORT
1 WHEEL OF FORTUNE
9 PRIME NEWS
11 WILD, WILD WORLD OF ANIMALS Once faced with extinction because of the use of DDT, the falcon is now making a comeback.
12 WKRP IN CINCINNATI A

wealthy, 80-year-old friend of Jennifer's dies and it is learned she was made executrix of his estate.
11 AMERICA'S JUNIOR MISS From Mobile, Alabama, the 20th annual pageant features 52 high school seniors judged on scholastic achievement, creative ability, performing arts, physical fitness and an interview. Five former Junior Miss winners act as judges. (Taped)

- 13 NEW! ANIMAL WORLD**
15 NASHVILLE NOW
17 CHAIN REACTION
19 ENTERTAINMENT TONIGHT Interview with Ted Shackelford ("Knots Landing").
21 ODYSSEY
23 CONGRESSIONAL HEARING
25 SPORTSCENTER
27 AMERICAN GIRLS
29 TWENTIETH CENTURY "Invasion Of Sicily" Nazis use this Italian island as a stopping stone to mainland Europe. Walter Cronkite hosts.
HBO WIMBLEDON TENNIS Same-day early round coverage from London.
SHOW BROTHERS Childhood differences resurface when old rivals, the Waters brothers come back to town. □

Daytime movies

- 5:00 **13** ★★½ "The Mighty Barnum" (1934, Biography) Adolphe Menjou, Wallace Beery.
 5:05 (SHOW) ★½ "Children Of The Corn" (1984, Horror) Peter Horton, Linda Hamilton.
 5:20 **HBO** ★★ "The Final Option" (1982, Drama) Judy Davis, Lewis Collins.
 5:30 (TMC) ★★½ "Vision Quest" (1985, Drama) Matthew Modine, Linda Fiorentino.
 5:10 **CIN** ★★½ "The Flamingo Kid" (1984, Comedy) Matt Dillon, Richard Crenna.
 7:30 (TMC) ★★½ "Cold Feet" (1983, Comedy) Griffin Dunne, Marissa Chibbas.
 8:00 **13** ★★½ "Nana" (1934, Drama) Anna Sten, Lionel Atwill.
 SHOW ★★½ "The Desperate Search" (1953, Drama) Howard Keel, Janie Greer.
CIN ★★½ "Sentimental Journey" (1948, Drama) John Payne, Maureen O'Hara.
 8:06 **13** ★★ "Susan Slept Here" (1954, Comedy) Dick Powell, Debbie Reynolds.
 9:00 **HBO** ★★ "Mom, The Wolfman And Me" (1980, Drama) Patty Duke Aulin, David Birney.
 (TMC) ★★½ "Up In Arms" (1944, Comedy) Danny Kaye, Dinah Shore.
 9:30 **SHOW** ★★ "Comfort And Joy" (1984, Comedy) Bill Paterson, Eleanor David.
 10:00 **CIN** ★★½ "Camelot" (1967, Musical) Richard Harris, Vanessa Redgrave.
 10:30 **13** ★★½ "Hog Wild" (1974, Drama) John Ericson, Denver Pyle.
 11:00 **13** ★½ "Panamint's Bad Man" (1938, Western) Smith Ballow, Evelyn Dow.
HBO ★★½ "My Science Project" (1985, Comedy) John Stockwell, Dennis Hopper.
 (SHOW) ★★½ "The Desperate

- Search" (1953, Drama) Howard Keel, Janie Greer.
 (TMC) ★★½ "Reuben, Reuben" (1983, Drama) Tom Conti, Kelly McGillis.
 11:05 **13** ★★ "Caribbean" (1952, Adventure) John Payne, Ariane Daxl.
 11:30 **SHOW** ★★ "Gremlins" (1984, Fantasy) Zach Galligan, Hoyt Axton.
 12:30 (SHOW) ★★ "Comfort And Joy" (1984, Comedy) Bill Paterson, Eleanor David.
 1:00 **13** ★★ "No Diamonds For Ursula" (1967, Mystery) Dana Andrews, Jean Valery.
HBO ★★ "Blam! On The Night" (1984, Drama) Nick Mancuso, Byron Thames.
 (TMC) ★★ "Royal Wedding" (1951, Musical) Fred Astaire, Jane Powell.
CIN ★★ "The Buddy Holly Story" (1978, Biography) Gary Busey, Don Stroud.
 2:00 **13** ★★½ "Young Boss" (1953, Drama) Joan Simmonds, Stewart Granger.
13 ★★ "Skin Deep" (1983, Drama) Olga Karlatos, Jann Carlos.
 2:30 **HBO** ★★½ "A View To A Kill" (1985, Adventure) Roger Moore, Tanya Roberts.
 (SHOW) ★★½ "Gremlins" (1984, Fantasy) Zach Galligan, Hoyt Axton.
 3:00 **13** ★★ "Kid Millions" (1935, Comedy) Eddie Cantor, Ethel Merman.
 (TMC) ★★½ "Cold Feet" (1983, Comedy) Griffin Dunne, Marissa Chibbas.
CIN ★★½ "Touched By Love" (1969, Drama) Deborah Raffin, Diane Lane.
 5:00 (TMC) ★★½ "Vision Quest" (1985, Drama) Matthew Modine, Linda Fiorentino.
 6:30 **CIN** ★★½ "The Stalking Moon" (1968, Western) Gregory Peck, Eva Marie Saint.

- 6:05 **13** **MOVIE** ★★½ "No Time For Sergeants" (1958, Comedy) Andy Griffith, Nick Adams.
 6:30 **13** **13** (11) **WHEEL OF FORTUNE**
13 **MISTER ED** "The Bank Robbery"
13 **WILD AMERICA** A look at a pair of orphaned fishers, cat-fished members of the wessal family, rescued and adopted by Marty Stouffer's family. (Part 1 of 2) □
13 **JEOPARDY**
13 **BENSON** Kattie's school friend thinks Benson would be the perfect mate for his widowed mother.
13 **ALICE** Alice, Flo and Vera visit a new singles bar.
13 **BUSINESS REPORT**
13 **M*A*S*H** Col. Potter, Hawkeye, B.J., Frank and Radar get hopelessly lost on their way back from a medical meeting.
13 (12) **NEWLYWED GAME**
13 **DONALD DUCK PRESENTS**
13 **ALL-STAR BLITZ**
13 **PM MAGAZINE** A woman who teaches self-esteem to children; baseball in Japan.
13 \$100,000 **PYRAMID**
13 **PRIME TIME ACCESS**
13 **SPLASH! SUMMER '88**
13 **AIR POWER** "Advance The Bomb-er Line" Marines secure Salpan for Allied airstrips. Walter Cronkite hosts.
 (SHOW) **THE WONDERFUL WORLD OF THE WOMBLES** Animated. Fat and fuzzy creatures, the Wombles, want a clean-world and embark on a

Daytime sports

- 8:30 **13** **SPORTSCENTER**
 7:00 **13** **WORLD CUP SOCCER SPECIAL**
 7:30 **13** **PGA SENIORS GOLF** Tournament Players Championship, final round, from Cleveland. (R)
 8:30 **13** **SPORTSLOOK**
 11:00 **13** **BOWLING** Budweiser Hall Of Fame Tournament, from St. Louis. (Taped)

- 12:00 **13** **WORLD CUP SOCCER** Semifinal game. (Live)
 2:00 **13** **RODEO**
 3:00 **13** **SPORTSLOOK**
 3:30 **13** **HORSE RACING WEEKLY**
 4:00 **13** **WORLD CUP SOCCER** Semifinal game. (Live)
 6:30 (7) **BASEBALL** Chicago Cubs at Philadelphia Phillies (Live)



6:05 p.m. (WTBS) **No Time For Sergeants** This 1958 comedy, based on Ira Levin's play, was a great success for Andy Griffith and Myron McCormick, as the hayseed inducted into the service and his harried drill sergeant, respectively. A cameo appearance by Don Knotts is also featured.

WEDNESDAY EVENINGS

| | 7:00 | 7:30 | 8:00 | 8:30 | 9:00 | 9:30 | 10:00 | 10:30 | 11:00 | 11:30 | 12:00 | 12:30 |
|------|-------------------------|-------------------------------|-----------|-------------------|------------|---------------------|-----------------------|-----------------|-------------------|-------|----------|-------|
| 2 | Ford's Theatre | Airwolf | | West 57th | News | D. Miller | T.J. Hooker | | | | Movie | |
| 4 | MacNeil / Lehrer | Smithsonian World | | Mandala | Fr. Dining | | Women Of South Africa | | | | | |
| 6 | MacGyver | Hardcastle | | Hotel | News | Entertain. | Nightline | | Hawaii Five-0 | | | |
| 7 | Highway To Heaven | G. Break | You Again | St. Elsewhere | News | Tonight | | David Letterman | News | | | |
| 9 | Star Trek | Movie: "Barefoot In The Park" | | | Jeffersons | Quincy | | C. Burnett | Ind. News | | | |
| 12 | Ford's Theatre | Airwolf | | West 57th | News | M*A*S*H | T.J. Hooker | | Movie | | | |
| SHOW | Wombles Cont'd | Honeymoners | | Brothers | Bizarre | Movie: "Caddyshack" | | | Movie: "Felicity" | | | |
| SHOW | Movie: "Caddyshack" | | | Movie: "Felicity" | | Movie: "Gremлина" | | | | | Movie | |
| HBO | Wimbledon Tennis Cont'd | Wimbled. | | Movie | | | George Carlin | | Hilchitzler | | Wimbled. | |

of the ongoing struggle to preserve this extraordinary city.
SHOW MOVIE ★★ "Caddyshack"

7:00 (2) (1) (11) ALL-STAR SALUTE TO FORD'S THEATRE Paul Anka, Sandy Duncan, Joel Grey, country singer Sylvia and singer-dancer Tommy Tune are among the performers in this tribute. Hosts: Richard Chamberlain, Jaclyn Smith.

(3) ISPY

(4) (4) MACNEIL / LEHRER NEWS HOUR

(5) (4) (4) MACGYVER □

(6) LARRY KING LIVE

(7) (1) HIGHWAY TO HEAVEN A Broadway actor turns a flop show into a hit when he claims he saw God in the third row. Guest: Michael London's former "Bonanza" co-star Lorna Greene. In stereo. (R) □

(8) SMITHSONIAN WORLD From a non-stop, refueled around-the-world flight to unexplored caves in the Bahamas -- the work of pioneers such as pilots and scientists as they try to conquer new frontiers. (R) □

(9) (12) STAR TREK An alien culture attempts to learn of good and evil through a battle to the death.

(10) 700 CLUB

(11) MOVIE ★★ "Superdad" (1974, Comedy) Bob Crane, Barbara Rush.

(12) CARTOONS

(13) PROJECT 2000: JIGSAW VALLEY Jigsaw Valley.

(14) VJ: MARK GOODMAN

(15) IN THE WILD WITH HARRY BUTLER

(16) PBA BOWLING Ebonite/Firebolt Classic, live from Seattle.

(17) REGIS PHILBIN'S LIFESTYLES

(18) VENICE PRESERVED Examination

Wednesday

You've tried everything.
Now try something that works.

For millions of dieters, keeping the weight off is the big problem. That's where the **NUTRI/SYSTEM** Program can help.

You eat nutritionally-balanced meals like Beef Burgundy, and Shrimp - Newburg.

And trained counselors help you learn how to control overeating, and which external cues trigger your desire for food.

NUTRI/SYSTEM worked for Kathy Williams.

It can work for you, too.



Celebrating 15 years of quality weight loss care.



Kathy Williams lost 31 lbs.

© 1986, NutriSystem, Inc. As people vary, so does the rate of their weight loss.



8 p.m. (KTRV) Barefoot In the Park. An entertaining 1967 Neil Simon screenplay, has Robert Redford and Jane Fonda as newlyweds living in a five-story walkup apartment. The gag about climbing the stairs grows thin, but the film doesn't.

We are so sure you will like our program we ask you to try it for

TWO WEEKS FREE

Call for details. Does not include cost of Nutri/System foods.
expires 6/30/86

525 Blue Lakes N.
Twin Falls
734-0405

1201 Normal
BURLEY
678-9781



Wednesday

(1980, Comedy) Bill Murray, Chevy Chase.

(TMC) MOVIE ★★ "Reuben, Reuben" (1983, Drama) Tom Conti, Kelly McGillis.

7:30 (1) NEW COUNTRY

(7) BOSOM BUDDIES

(8) STATIONARY ARK

(9) VIEWER CALL-IN

CIN MAXTRAX

8:00 (2) (3) (4) (11) AIRWOLF An attempted kidnapping mars Caitlin's (Jean Bruce Scott) sorority reunion. (R)

(5) ROUTE 66

(6) (12) SMITHSONIAN WORLD From a non-stop, unrefueled around-the-world flight to unexplored caves in the Bahamas -- the work of pioneers such as pilots and scientists as they try to conquer new frontiers. (R) (Q)

(7) (8) (9) HARDCASTLE AND MCCORMICK The judge and Mark discover clues to a councilman's murder. (R) (Q)

(10) NEWS

(11) (12) GIMME A BREAK! In stereo.

(13) MANDELA A profile of South African civil rights activist Winnie Mandela, focuses on her efforts to change South Africa's practice of apartheid and the enforced separation from her husband Nelson, imprisoned since 1962 for his political beliefs. (Q)

(14) (12) MOVIE ★★ "Barefoot in the Park" (1967, Comedy) Robert Redford, Jane Fonda.

(15) CROOK AND CHASE

(16) RADIO 1990

(17) LIVE ROMANCE 1990: SHEILA E A special guest appearance by Prince and The Revolution for a rendition of "Love Bazaar" and a congo performance by Pete Escovedo highlight this February 1986 performance by Sheila E at the Paramount Theater in Oakland. Other songs include "Sister Fate," "Glamorous Life," and "Erotic City."

(18) AUSTRALIAN ARK

(19) DR. RUTH SHOW

(20) ARISTOCRATS German Prince Johannes Thurm and Taxis and his young wife.

(SHOW) HONEYMOONERS: THE LOST EPISODES While their apartment is being painted the Nortons move in with the Kramdens; Ralph has trouble getting through a rehearsal of a speech he is giving at the Raccoon Lodge without being interrupted. (Q)

CIN BRITISH ROCK: THE FIRST WAVE A montage of clips of the Beatles, the Rolling Stones, The Kinks and The Who highlight this look at the British rock invasion of the mid-60's.

8:30 (2) (3) (7) YOU AGAIN? Henry's angry when Matthew announces his pregnant girlfriend is moving into his room. In stereo. (R) (Q)

(4) BASEBALL Atlanta Braves at Los Angeles Dodgers (Live)

(6) NEWS

(8) AMERICAN SNAPSHOTS

(9) VIDEOCOUNTRY

(10) WILD, WILD WORLD OF ANIMALS

(11) NEWS

(20) TODAY IN WASHINGTON

(20) WIMBLEDON TENNIS Highlights of the day's matches.

8:45 (2) MOUSETERPIECE THEATER

8:45 SHOW COMEDY CLOSURE

9:00 (2) (3) (7) (11) WEST 57TH

(1) MOVIE ★★ "The Green Man" (1957, Comedy) Alastair Sim, Jill Adams.

(4) (12) MANDELA A profile of South African civil rights activist Winnie Mandela, focuses on her efforts to change South Africa's practice of apartheid and the enforced separation from her husband Nelson, imprisoned since 1962 for his political beliefs. (Q)

(5) (6) (9) HOTEL Heart problems put a strain on a marriage; an extramarital affair loses its luster when the other woman discovers her lover isn't married; hotel guests claim their luggage has been stolen. (R) (Q)

(8) MONEYLINE

(7) (8) (1) ST. ELSEWHERE West-phall becomes seriously ill; lifesaving surgery impairs a patient's sex life; Turner lends advice to a childless couple. (R)

(12) WOMEN OF SOUTH AFRICA Two films looking at apartheid's effect on women: "Maids and Madams" examines the relationship of the black domestic worker to her white "madam"; "South Africa Belongs to Us" profiles the struggles of five black women including political activist Winnie Mandela.

(13) BILL COSBY

(15) EDISON TWINS "Tinker Tom" After winning an award for an invention, Tom gets carried away inventing things to automate the entire Edison household.

(16) YOU CAN BE A STAR

(17) WRESTLING

(18) VJ: MARK GOODMAN

(19) A FEELING FOR FRANCE

(20) NFL'S GREATEST MOMENTS The Glory of Notre Dame Football.

(1) MOVIE ★ "Skin Deep" (1983, Drama) Olga Karlova, Juan Carlos.

(2) GREAT DETECTIVE "Fire at Fagroy" An arsonist is loose in a small farming village.

(3) MOVIE ★★ "The Last Married Couple in America" (1980, Comedy) George Segal, Natalie Wood.

(SHOW) BROTHERS Childhood differences resurface when old rivals of the Walters brothers come back to town. (Q)

(SHOW) MOVIE ★ "Felicity" (1978, Drama) Glory Annen, Christopher Mink.

(TMC) MOVIE ★ "Night School" (1981, Mystery) Leonard Mann, Rachel Ward.

CIN MOVIE ★★ "The Buddy Holly Story" (1978, Biography) Gary Busey, Don Stroud.

9:30 (3) SPORTS TONIGHT

(7) TRAPPER JOHN, M.D.

(8) BURNS AND ALLEN Gracie's good Samaritan side comes through when she helps her new cleaning woman.

(9) DANGER BAY A plane crash strands Grant, J.L., and George Dunbar in the mountains.

(10) FANDANGO

(11) SPORTSCENTER

(SHOW) BIZARRE (Q)

10:00 (2) (3) (4) (5) (6) (7) (8) (9) (10) (11) NEWS

(12) DINING IN FRANCE This tour of French vineyards includes the "Night of the Beaujolais" celebration, Baron Rothschild's Madoc chateau, a wine luncheon, and interviews with wine experts.

(13) NEWSNIGHT

(12) JEFFERSONS Lionel and Jenny have a baby girl. (Part 2 of 2) (Q)

(1) JACK BENNY Billy Wilder wants to cast Jack in a new movie.

(2) MOVIE ★★ "Paris Holiday" (1958, Comedy) Bob Hope, Fernand.

(3) NASHVILLE NOW

(4) BOXING Johnny "Dancing Machine" Carter (31-1, 10 KO's) vs. Juan Veloz (13-5-2, 0 KO's) in a super bantamweight bout scheduled for 10 rounds, from Philadelphia. (Taped)

(5) DISAPPEARING WORLD

(6) ACTION SPORTS OF THE 80's 1985 World Offshore Powerboat Championship from Key West, Fla.

(7) TWENTIETH CENTURY "Invasion Of Sicily" Nazis use this Italian island as a stepping stone to mainland Europe. Walter Cronkite hosts.

(8) (SHOW) MOVIE ★★ "Caddyshack" (1980, Comedy) Bill Murray, Chevy Chase.

10:20 SHOW MOVIE ★★ "Grenada" (1984, Fantasy) Zach Galligan, Hoyt Axton.

10:30 (7) BARNEY MILLER Weis expresses his fear of flying just as he is about to accompany a prisoner of a flight to Cleveland.

(8) (10) WOMEN OF SOUTH AFRICA Two films looking at apartheid's effect on women: "Maids and Madams" examines the relationship of the black domestic worker to her white "madam"; "South Africa Belongs to Us" profiles the struggles of five black women including political activist Winnie Mandela.

(9) (8) TONIGHT Host: Johnny Carson. Scheduled: comedian Steve Landesberg. In stereo.

(7) DOCTOR WHO "The Revenge of the Cybermen" The Cybermen plot to destroy the planet of gold. (Part 3 of 4)

(12) QUINCY Quincy investigates an evangelist's alleged suicide.

(3) MOVIE ★★ "The Brothers Karamazov" (1958, Drama) Maria Schell, Yul Brynner.

(11) M*A*S*H Charles becomes obsessed with death following a sniper attack.

(1) BEST OF GROUCHO

(2) AIR POWER "Advance The Bomb or Line" Marines secure Saipan for Allied airstrips. Walter Cronkite hosts.

10:35 (2) TAXI Louie's girlfriend Zena takes him home to meet her parents.

(4) WKRP IN CINCINNATI

(5) ENTERTAINMENT TONIGHT Interview with Tad Shacketford ("Knots Landing").

(7) TONIGHT Host: Johnny Carson. Scheduled: comedian Steve Landesberg. In stereo.

(8) NIGHTLINE

10:40 (6) M*A*S*H

11:00 (2) (11) T.J. HOOKER Hooker tries to break up a drug ring that is forcing compulsive gamblers to act as couriers. (R)

(3) MISTER ED "The Bank Robbery"

(4) CROSSFIRE

Wednesday

7 NICARAGUA WAS OUR HOME Lea Shapiro's secretly filmed documentary about the Miskito Indians' plight in eastern Nicaragua includes footage of the escape by 2,000 refugees whose number included two American pilots identified as Miskito contra assassination victims by the Sandinista government.

11 DOBIE GILLIS

12 JOURNEY INTO INDIA

13 TENNIS MAGAZINE REPORTS

14 EVERYBODY'S MONEY MATTERS

15 VENICE PRESERVED Examination of the ongoing struggle to preserve this extraordinary city.

HBO GEORGE CARLIN IN CONCERT: PLAYIN' WITH YOUR HEAD Carlin's sixth HBO appearance featuring all-new uncensored material.

(TMC) MOVIE ★★ "Weekend Pass" (1984, Comedy) D.W. Brown, Peter Ellenstein.

CIN A ROCKABILLY SESSION: CARL PERKINS AND FRIENDS George Harrison, Rosanne Cash, Ringo Starr, Dave Edmunds and former members of the Stray Cats gather for a jam session with rock 'n' roll legend Carl Perkins.

11:05 11 T.J. HOOKER Hooker tries to break up a drug ring that is forcing compulsive gamblers to act as couriers. (R)

12 JEFFERSONS

13 NIGHTLINE

14 700 CLUB

11:10 12 T.J. HOOKER Hooker tries to break up a drug ring that is forcing compulsive gamblers to act as couriers. (R)

11:15 11 MOVIE ★★ "Hurricane Smith" (1952, Adventure) Yvonne De Carlo, John Ireland.

11:30 11 DONNA REED Jeff Iselt tells women couldn't handle the rigors of a car rally.

12 NEWSNIGHT UPDATE

13 11 LATE NIGHT WITH DAVID LETTERMAN Scheduled: comedian Billy Crystal, performance artist Laurie Anderson, in stereo.

14 12 CAROL BURNETT AND FRIENDS Skits: The Hot Dog Stand, The Morning After.

15 FATHER KNOWS BEST Jim and Margaret are pleasantly surprised when they are visited by a mutual college friend.

16 NEW COURTY

17 HANDS

18 TODAY IN WASHINGTON

19 FISHING-1985 Arthur Smith KDW Tournament, from Palm Beach, Fla.

11:35 11 ROCKFORD FILES

12 HAWAII FIVE-O A young Marine is killed, a break-down, and imagines himself back in a bottle zone in Vietnam.

13 ENTERTAINMENT TONIGHT Interview with Ted Shackelford ("Knots Landing").

11:45 11 DTV

(SHOW) COMEDY CLOSEUP

12:00 11 SPY

12 HEART OF THE DRAGON A survey of contemporary Chinese science and technology, ranging from satellite communication to medicinal foods. (R) □

13 12 INDEPENDENT NEWS

14 700 CLUB

15 ADVENTURES OF OZZIE & HARRIET "Ricky The Milkman"

16 FIRE ON THE MOUNTAIN

17 ALFRED HITCHCOCK HOUR

18 VJ: J.J. JACKSON

19 BREAKTHROUGH

20 SPORTSLOOK

21 ARISTOCRATS German Prince Johannes Thurm and Taxis and his young wife.

HBO THE HITMAKER Susan Anspacher stars in this thriller about a novelist who uses her hometown's most intriguing secrets in her books. (SHOW) MOVIE ★★ "Felicity" (1978, Drama) Glory Annen, Christopher Milne.

CIN ROCK AND ROLL: THE EARLY DAYS The roots of rock 'n' roll are traced through the careers of Bill Haley, the Everly Brothers, Fats Domino, Buddy Holly, Bo Diddley, Elvis Presley and others.

12:05 12 LATE NIGHT WITH DAVID LETTERMAN Scheduled: comedian Billy Crystal, performance artist Laurie Anderson, in stereo.

13 JIMMY SWAGART

12:10 12 (1) MOVIE ★★ "I'm Going To Be Famous" (1981, Drama) Dick Sargent, Meredith MacRae.

12:15 11 MOVIE ★★ "I'm Going To Be Famous" (1981, Drama) Dick Sargent, Meredith MacRae.

SHOW MOVIE ★★ "Mike's Murder" (1984, Drama) Debra Wingar, Mark Keyloun.

12:20 12 MOVIE ★★ "I'm Going To Be Famous" (1981, Drama) Dick Sargent, Meredith MacRae.

12:30 12 SPORTS LATE NIGHT

13 NEWS

14 MOVIE ★★ "Bells Are Ringing" (1980, Musical) Judy Holliday, Dean Martin.

15 DANCIN' USA

16 NEW TECH TIMES

17 SPORTSCENTER

HBO WIMBLEDON TENNIS Highlights of the day's matches.

12:35 12 BENNY HILL

12:45 HBO MOVIE ★★½ "A View To A Kill" (1985, Adventure) Roger Moore, Tanya Roberts.

1:00 11 ROUTE 66

12 NEWS OVERNIGHT

13 COMEDY BREAK

14 MOVIE ★★ "The Town Went Wild" (1944, Comedy) Freddie Bartholomew, Jimmy Lydon.

15 60 MINUTES TO SUCCESS

16 EDGE OF NIGHT

17 WORLD CUP SOCCER Semifinal game. (R)

18 SUCCESS IS NOT AN ACCIDENT

19 GREAT DETECTIVE "Fire At Fenroy" An arsonist is loose in a small farming village.

(TMC) MOVIE ★★ "Royal Wedding" (1951, Musical) Fred Astaire, Jane Powell.

CIN MOVIE ★★½ "Tutt Tut!" (1984, Drama) James Spader, Kim Richards.

1:05 12 FANTASY ISLAND

13 PERFECT MATCH

1:10 11 MOVIE ★★½ "Guns Of Zangera" (1959, Drama) Robert Stack, Robert Middleton.

1:20 (SHOW) MOVIE ★★ "Gram-Jina" (1984, Fantasy) Zach Galligan, Hoyt Axton.

1:30 11 INDEPENDENT NEWS

14 THAT GIRL

1:35 11 IN SEARCH OF... "Hicc Treasures"

1:45 11 NIGHTWATCH

2:00 11 MOVIE ★★ "The Green Man" (1937, Comedy) Alastair Sim, Jill Adams.

12 LARRY KING OVERNIGHT

13 MOVIE ★★½ "Return Of The Fly" (1959, Horror) Vincent Price, Brett Halsey.

14 TOM HOPKINS ON SELLING

15 DICK CAVETT Guests: Lee Grant, Malcolm Forbes.

16 MAKING MONEY WITH GOVERNMENT LOANS

2:05 11 NEWS

2:10 SHOW MOVIE ★★½ "Caddyshack" (1980, Comedy) Bill Murray, Chevy Chase.

2:30 11 MOVIE ★★ "Kipps" (1941, Drama) Michael Redgrave, Diana Wynyard.

12 TODAY IN WASHINGTON

2:35 (TMC) MOVIE ★★ "The Sensuous Nurse" (1978, Comedy) Ursula Andress, Duilio Del Prete.

2:45 CIN MOVIE ★★½ "Birdy" (1984, Drama) Matthew Modine, Nicholas Cage.

3:00 12 CROSSFIRE

13 GET RICH WITH REAL ESTATE

14 MOVIE ★★ "No Diamonds For Ursula" (1967, Mystery) Dana Andrews, Joan Velez.

15 AUTO RACING 24 Hours of LeMans from France. (R)

16 INVESTMENT ADVISORY

3:10 12 WORLD AT LARGE

HBO RAPISTS: HOW CAN THEY BE STOPPED? This documentary, focusing on live case studies of men at the Oregon State Penitentiary, deals with why men rape and examines the men who commit the crime.

3:15 (SHOW) MOVIE ★★ "Mike's Murder" (1984, Drama) Debra Wingar, Mark Keyloun.

3:30 13 SHOWBIZ TODAY

14 BEVERLY HILLBILLIES

3:40 SHOW HONEYMOONERS: THE LOST EPISODES While their apartment is being painted the Nortons move in with the Kramdons; Ralph has trouble getting through a rehearsal of a speech he is giving at the Raccoon Lodge without being interrupted. □

4:00 13 ADVENTURES OF BLACK REALITY

MACIE'S BOOTS

And Western Wear

210 Main Avenue South, Twin Falls
733-5439

Best Darn Boot & Shoe Repair in Idaho!

We Sell 'Em And Fix 'Em — Let Our Expert Repairmen Fix You Up!





Thursday evening programs

- 6:00 **NEWS**
3 MY THREE SONS
10 BUSINESS REPORT
4 WHEEL OF FORTUNE

3 PRIMENEWS
2 WILD, WILD WORLD OF ANIMALS Unlike Antarctica, where large animals are conspicuously absent, the Arctic boasts many large ani-

mals.
2 (12) WKRP IN CINCINNATI Norma Carlson hires a radio consultant who turns out to be an old buddy of Andy's.

Daytime movies

5:00 **3** ★★ "The Last Circus Show" (1974, Drama) James Whitmore, Lee J. Cobb.

CIN ★★½ "Love Letters" (1983, Drama) Jamie Lee Curtis, James Keach.

5:10 **(SHOW)** ★★½ "Caddyshack" (1980, Comedy) Bill Murray, Chevy Chase.

5:55 **HBO** ★★ "Alphabet City" (1984, Drama) Vincent Spano, Kate Vernon.

6:00 **SHOW** ★★½ "Grease" (1978, Musical) John Travolta, Olivia Newton-John.

(TMC) ★★ "I Want You" (1952, Drama) Dana Andrews, Dorothy McGuire.

7:30 **HBO** ★★ "White Water Sam" (1977, Adventure) Keith Laren.

8:00 **(10)** ★★ "Decameron Nights" (1953, Drama) Joan Fontaine, Louis Jourdan.

SHOW ★★ "The Opposite Sex" (1956, Comedy) June Allyson, Dolores Gray.

(TMC) ★★½ "Harold and Maude" (1971, Comedy) Ruth Gordon, Bud Cort.

CIN ★★½ "F.I.S.T." (1978, Drama) Sylvester Stallone, Peter Boyle.

8:05 **3** ★★½ "The Matchmaker" (1958, Comedy) Shirley Booth, Anthony Perkins.

8:00 **HBO** ★★ "Henky Panky" (1982, Comedy) Gene Wilder, Gilda Radner.

(SHOW) ★★ "Grease" (1978, Musical) John Travolta, Olivia Newton-John.

9:30 **(TMC)** ★★ "Rhinestone" (1984, Comedy) Sylvester Stallone, Dolly Parton.

10:00 **SHOW** ★★½ "Sounder" (1972, Drama) Cicely Tyson, Paul Winfield.

10:30 **3** ★★½ "Summer Magic" (1983, Musical) Hayley Mills, Burl Ives.

CIN ★★ "Grease" (1978, Musical) John Travolta, Olivia Newton-John.

11:00 **3** ★★ "Phantom Patrol" (1936, Western) Kermit Maynard.

HBO ★★ "A Matter Of Life And Death" (1980, Drama) Linda Lavin, Salome Jens.

(SHOW) ★★ "The Opposite Sex"

(1956, Comedy) June Allyson, Dolores Gray.

11:05 **3** ★★ "El Paso" (1949, Western) John Payne, Gail Russell.

11:30 **(TMC)** ★★½ "Hambone And Hillie" (1984, Comedy) Lillian Gish, Timothy Bottoms.

12:00 **SHOW** ★★ "Grease" (1978, Musical) John Travolta, Olivia Newton-John.

12:30 **CIN** ★★ "Bells Are Ringing" (1980, Musical) Judy Holiday, Dean Martin.

1:00 **(10)** ★★ "The Last Circus Show" (1974, Drama) James Whitmore, Lee J. Cobb.

HBO ★★ "Kolly" (1981, Drama) Robert Logan, Twyla-Dawn Vokins.

(SHOW) ★★ "Sounder" (1972, Drama) Cicely Tyson, Paul Winfield.

(TMC) ★★ "Condemned" (1930, Drama) Ronald Colman, Ann Harding.

2:00 **(10)** ★★½ "Jungle Cat" (1960, Documentary) Narrated by Winston Hibler.

(10) "Body Business" (1983, Drama) (Part 1 of 2) Jane Marelaus, Carmen Duncan.

3:00 **(10)** ★★ "My Favorite Brunette" (1947, Comedy) Bob Hope, Dorothy Lamour.

HBO ★★½ "Fleisch" (1985, Comedy) Chevy Chase, Joe Don Baker.

(SHOW) ★★ "Groaaaan" (1978, Musical) John Travolta, Olivia Newton-John.

(TMC) ★★ "The Return Of Martin Guerre" (1981, Drama) Gerard Depardieu, Nathalie Baye.

CIN ★★ "Seems Like Old Times" (1980, Comedy) Goldie Hawn, Chevy Chase.

4:00 **SHOW** ★★ "The In-Laws" (1979, Comedy) Alan Arkin, Peter Falk.

5:00 **(TMC)** ★★ "Rhinestone" (1984, Comedy) Sylvester Stallone, Dolly Parton.

5:30 **(10)** ★★ "Professor Wagstaff's Time Machine" (1983, Adventure) Michael McVay, Theona McLellan.

CIN ★★ "Never So Few" (1980, Drama) Frank Sinatra, Gina Lollobrigida.

Daytime sports

- 6:30 **(10) SPORTSCENTER**
 7:00 **(10) HORSE RACING WEEKLY**
 7:30 **(10) WORLD CUP SOCCER** Semifinal game. (R)
 9:30 **(10) SPORTSLOOK**
 11:00 **(10) TOP RANK BOXING** Jimmy Navarro vs. Darryl Thigpen in a banterweight bout scheduled for 12 rounds, from Atlantic City, N.J. (R)
 1:30 **(10) SURFING** Men's World Cup

- from Oahu, Hawaii. (R)
 2:00 **(10) HORSESHOW** Upperville Jumper Classic, from Upperville, Va. (R)
 3:30 **(10) TENNIS MAGAZINE REPORTS**
 4:00 **(10) SPORTSLOOK**
 4:30 **(10) INSIDE THE PGA TOUR**
 5:00 **(10) SPORTSCENTER**
 5:30 **(10) SPEEDWEEK**

3 **MOVIE** ★★ "Busting" (1973, Drama) Elliott Gould, Robert Blake.

10 **WACKIEST SHIP IN THE ARMY** Under the guise of helping the ARMY, a young woman leads Butcher (Jack Warden) and Rip (Gary Collins) into a Japanese trap.

10 **NASHVILLE NOW**
10 **CHAIN REACTION**
4 **ENTERTAINMENT TONIGHT** Interview with actress Lauren Hutton.

10 **BREAKTHROUGHS**
10 **CONGRESSIONAL HEARING**
10 **AUTO RACING IMSA Camel Grand Prix**, from West Palm Beach, Fla. (R)

10 **CASSIE & CO.**
10 **TRUCKACER** Tchaikovsky's classic ballet with principal roles performed by Lesley Collier and Anthony Dowell. Hosted by Joan Fontaine.

HBO WIMBLEDON TENNIS Same-day early round coverage from London.

(SHOW) ROOM TO MOVE Terence Donovan and Nicole Kidman star in this story of a young track star who realizes that being content with one-self is more important than being number one.

SHOW MOVIE ★★ "Sounder" (1972, Drama) Cicely Tyson, Paul Winfield.

8:05 **10** **MOVIE** ★★ "5 Card Stud" (1988, Western) Dean Martin, Robert Michum.

8:30 **3** **(10) (11) WHEEL OF FORTUNE**

10 **MISTER ED** "My Horse, The Mailman"

10 **WILD AMERICA** Marty Stouffer searches for signs that the mating leibers can survive their first winter in the wild. (Part 2 of 2) **2**

4 **JEEPARDY**
3 **BENSON** When impending fatherhood overwhelms Pete, he tries to be a coffeehouse poet again.

3 **ALICE** Mel injures his back at Alice's apartment and has to stay there for two weeks.

7 **BUSINESS REPORT**
10 **M*A*S*H** An Intelligence officer and a psychiatrist grapple for the fate of a wounded allicer who claims he's Jesus Christ.

10 **NEWLYWED GAME**
10 **DONALD DUCK PRESENTS**
10 **ALL-STAR BLITZ**

10 **PM MAGAZINE** Ruth and Nathan Hale, owners of Utah's most successful new theatre; Santa Monica's (Calif.) Muscle Beach.

5 **\$100,000 PYRAMID**
10 **PRIME TIME ACCESS**
10 **NEW TECH TIMES**

7:00 **3** **(10) (11) CRAZY LIKE A FOX** A fashion designer turns to Harry and Harrison when she begins receiving threatening phone calls from her supposedly dead partner. (R)

1 **ISPY**
10 **MAQNEIL / LEHRER NEWS HOUR**

3 **3** **REPLY'S BELIEVE IT OR NOT!** Segments include a visit to the Los Angeles County coroner's office.

THURSDAY EVENING

| | 7:00 | 7:30 | 8:00 | 8:30 | 9:00 | 9:30 | 10:00 | 10:30 | 11:00 | 11:30 | 12:00 | 12:30 |
|------|-------------------------|-----------|--------------------------|-----------|--------------------|------|------------|---------------------|------------|-----------------|-------------------|-------|
| 2 | Crazy Like A Fox | | Trapper John, M.D. | | Knots Landing | | News | B. Mider | Night Heat | | Movie: "Deadline" | |
| 4 | Machell / Lehrer | | Symposium | Of Nature | Mystery! | | Moneyma. | Masterpiece Theatre | | | | |
| 6 | Ripley's | | The Colby's | | 20 / 20 | | News | Entertain. | Nightline | Hawaii Five-0 | | |
| 7 | Cosby | Fam. Ties | Cheers | N. Court | Hill Street Blues | | News | Tonight | | David Letterman | | News |
| 9 | Star Trek | | Movie: "Midnight Cowboy" | | | | Jeffersons | Quincy | | C. Burnett | Ind. News | |
| 12 | Crazy Like A Fox | | Trapper John, M.D. | | Knots Landing | | News | M*A*S*H | Night Heat | | Movie: "Deadline" | |
| SHOW | Movie: "The In-Laws" | | | | Movie: "Sounder" | | | Honeymooners | | | Movie | |
| SHOW | Movie Cont'd | | Honeymooners | | Movie: "Tightrope" | | | Movie: "Nutcracker" | | | | |
| HBO | Wimbledon Tennis Cont'd | | | Wimbleb. | Movie: "Blackout" | | | Hitchhiker | | Philip Marlowe | Wimbleb. | |

ay rooms and an examination of airline industry measures to insure passenger safety. (R) □

5 LARRY KING LIVE

7 (1) (1) COSBY SHOW Vanessa's school grades suffer when she develops a crush on a boy. In stereo. (R) □

(7) HEART OF THE DRAGON A look at China's attempts to encourage trade and free enterprise while maintaining control of its economy. (R) □
 (12) STAR TREK Kirk, Spock and McCoy are trapped in the past when they return to the present means death.

11 700 CLUB

13 CHILDREN OF THE WORLD

15 CARTOONS

16 VJ: MARK GOODMAN

23 ONCE IN A LIFETIME

(14) REGIS PHILBIN'S LIFESTYLES (SHOW) MOVIE ★★★ "The In-Laws" (1979, Comedy) Alan Arkin, Peter Falk.

(TMO) MOVIE ★★★ "Harold and Maude" (1971, Comedy) Ruth Gordon, Bud Cort.

7:10 (10) MOVIE ★★★ "The Secret Of N.I.M.H." (1982, Fantasy) Animated. Voices of Elizabeth Hartman, Dom DeLuise.

7:30 (7) (1) (7) FAMILY TIES In stereo.

10 NEW COUNTRY

20 VIEWER CALL-IN

(7) AUTO RACING SPECIAL: NIKKI LAUDA EXPLAINS FORMULA ONE. CIN MOVIE ★★★ "Tender Mercies" (1982, Drama) Robert Duvall, Tess Harper.

8:00 (7) (1) (2) (11) TRAPPER JOHN, M.D. Artificial-heart recipient Jack Dearborne remains in guarded condition; Gonzo discovers that his current love has multiple sclerosis. (Part 2 of 2) (R)

13 ROUTE 66

(3) (10) BORAH SYMPOSIUM "Search For Peace In The Middle East"

(4) (3) (3) THE COLBY'S Mitos accuses Fallon of being unable to choose between him and Jeff; Sablo tries to reconcile with Jason. (R) □

17 NEWS

(7) (3) (7) CHEERS Diane uses Sam as the subject of her psychology term paper. In stereo. (R)

17 BUSINESS WEBB

(3) (12) MOVIE ★★★ "Midnight Cowboy" (1969, Drama) Dustin Hoffman, Jon Voight.

10 CROOK AND CHASE

13 RADIO 1000

13 AMERICAN ANTHEM PARTY

21 HORIZON

(1) AUTO RACING Formula One Canadian Grand Prix, from Circuit Gilles Villeneuve on Ile de Notre Dame in Montreal. (R)

13 DR. RUTH SHOW

SHOW HONEYMOONERS: THE LOST EPISODES After Alice refuses to give them money, Ralph and Norton get a bank loan to start up a business. □

8:15 (3) MOVIE ★★★ "3:10 To Yuma" (1957, Western) Glenn Ford, Van Heflin.

6:30 (3) (10) PROFILES OF NATURE

(2) (8) (7) NIGHT COURT Feeling responsible for the tragic shooting of a boy, Harry quits the bench and vanishes. (Part 2 of 2) In stereo. (R)

(7) CAPITOL JOURNAL

(1) PLEASE DON'T LET ME DIE

(13) MOUSEPIECE THEATER

(1) VIDEOCOUNTRY

(13) WILD, WILD WORLD OF ANIMALS

(10) TODAY IN WASHINGTON

(3) IT WAS OF EDEN I WAS DREAMING Host Zoe Caldwell brings to life the turbulent world of revolutionary poet Arthur Rimbaud.

HBO WIMBLEDON TENNIS Highlights of the day's matches.

(TMO) MOVIE ★★ "Porky's" (1981, Comedy) Dan Monahan, Mark Herrier.

9:00 (2) (1) (2) (2) (11) KNOTS LANDING Gary learns the secret of Empire Valley and forces Abby to join in his plan; Cathy attempts to escape from Lillamae. (R) □

(3) MOVIE ★★ "Carnival Story" (1954, Adventure) Anne Baxter, Steve Cochran.

(3) (7) (10) MYSTERY! "Agatha Christie's Partners in Crime" Tommy and Tuppence Beresford help a clergyman's daughter whose meager livelihood is threatened by strange events at her country boardinghouse. (R) □

(4) (3) (2) 20 / 20 □

(3) MONEYLENE

(7) (8) (7) HILL STREET BLUES A macho plumber makes a play for Bates; Belker tries to determine which of the Rabinowitz twins is responsible for a diamond theft. (R)

(1) SOAP Burt and Mary see a psychiatrist about Burt's impotence and cousins Eunice Tate and Jodie Dallas accidentally meet.

(1) BILL COSBY

(1) BEST OF WALT DISNEY PRE-

Thursday

13 STUNTS

(13) YOU CAN BE A STAR

(13) MOVIE ★★★ "Superfly T.N.T." (1973, Adventure) Ron O'Neal, Roscoe Lee Brown.

(7) MRS. LIVINGSTON, I PRESUME (15) MOVIE "Glass Babies" (1985, Drama) (Part 1 of 2) Belinda Davey, Gary Day.

(4) PILOBOLUS Pilobolus Dance Co. joins the Royal Danish Ballet Company for three innovative works including pieces by Mosea Pendleton and Jonathan Wolken, with music by Laurie Anderson and others.

HBO MOVIE ★★★ "Blackout" (1985, Mystery) Richard Widmark, Keith Carradine.

(SHOW) MOVIE ★★★ "Sounder" (1972, Drama) Cicely Tyson, Paul Winfield.

SHOW MOVIE ★★★ "Tightrope" (1984, Suspense) Clint Eastwood, Genevieve Bujold.

CIN MOVIE ★★★ "Grease" (1978, Musical) John Travolta, Olivia Newton-John.

9:30 (5) SPORTS TONIGHT

(7) TRAPPER JOHN, M.D.

(1) BURNS AND ALLEN Gracie has the mistaken idea that a surprise party planned for Harry Morton is actually meant for George.

(1) FANDANGO

(1) SPORTSCENTER

10:00 (3) (1) (4) (3) (7) (12) (7) (3) (2)

(11) NEWS

(3) (10) MONEYMAKERS



8:15 p.m. (WTBS) 3:10 to Yuma Glenn Ford, Van Heflin, Felicia Farr and Richard Jaeckel star in this suspenseful, first-rate 1957 Western. Director Delmer Daves maintains the tension as captured outlaw Ford attempts to psyche out his reluctant keeper, Heflin, while he waits for lawmen to arrive on the train.

Thursday

- NEWSNIGHT**
NOT THE NINE O'CLOCK NEWS
(12) JEFFERSONS George's a gift to Jessica disappoints Lionel and Jenny. **□**
JACK BENNY Jack dreams he's Alexander Hamilton. **□**
MOVIE ★★ "Bully" (1978, Biography) James Whitmore. **□**
NASHVILLE NOW
V.J. MARK GOODMAN
PORTRAITS OF POWER
SURFING Men's World Cup from Oahu, Hawaii. (R)
NUTCRACKER Tchaikovsky's classic ballet with principal roles performed by Lesley Collier and Anthony Dowell. Hosted by Joan Fontaine.
MOVIE ★★ "The Comic" (1988, Drama) Dick Van Dyke, Michele Lee.
BARNEY MILLER A battle of the sexes erupts when Manhattan South takes the credit after Del. Janice Wentworth subdues a would-be assassin.
MASTERPIECE THEATRE "The Irish R.M.": Flurry Knox challenges a visiting maharaja's polo team to a match. (Part 5 of 8) **□**
TONIGHT Host: Johnny Carson. Scheduled: actor Danny DeVito; John Searing. In stereo.
DOCTOR WHO "The Revenge Of The Cybermen": The Doctor and Sarah find themselves destined to be part of the biggest explosion in history. (Part 4 of 4)
(12) QUINCY Quincy must determine whether a pregnant girl's fall from a cliff was a suicide or murder.
MOVIE ★★ "Duel At Diablo" (1968, Western) James Garner, Sidney Poitier.
(11) M*A*S*H The sudden illness of a USO singer brings the touring troupe to the 4077th. (Part 1 of 2)
BEST OF GROUCHO
BEST KEPT SECRETS
FISHIN' HOLE
(TMC) MOVIE ★★ "The Return Of Martin Guerre" (1981, Drama) Gerard Depardieu, Nathalie Baye.
TAXI The cabbies convince Tony to adopt 8-year-old Brian Sims.
WKRP IN CINCINNATI
ENTERTAINMENT TONIGHT Interview with actress Lauren Hutton.
TONIGHT Host: Johnny Carson. Scheduled: actor Danny DeVito; John Searing. In stereo.
NIGHTLINE
M*A*S*H
(11) NIGHT HEAT When an elderly acquaintance disappears from a nursing home, Giambone's grandmother asks him to investigate. (R)
MISTER ED "My Horse, The Mailman"
CROSSFIRE
PAVARTOTTI IN THE VERDI REQUIEM: A SALUTE TO YOUTH Winners of the Opera Company of Philadelphia / Luciano Pavarotti International Voice Competition join the renowned tenor in a performance of Verdi's "Requiem" taped at the Philadelphia Spectrum. Soloists: soprano Susan Dunn, mezzo-soprano Lidko Komlosi and bass Pasta Burchu-

- ladze.
DOBBIE GILLIS
GANGSTER CHRONICLES
DIAMONDS IN THE SKY
EVERYBODY'S MONEY MATTERS
HBO THE HITCHHIKER A family mansion becomes a horror chamber for a young invalid (Jenny Seagrave).
(SHOW) HONEYMOONERS: THE LOST EPISODES After Alice refuses to give them money, Ralph and Norton get a bank loan to start up a business. **□**
SHOW MOVIE "Nutcracker" (1984, Drama) Joan Collins, Carol White.
CIN MOVIE ★★ "Seems Like Old Times" (1980, Comedy) Goldie Hawn, Chevy Chase.
(11:05) NIGHT HEAT When an elderly acquaintance disappears from a nursing home, Giambone's grandmother asks him to investigate. (R)
JEFFERSONS
NIGHTLINE
700 CLUB
(11:10) NIGHT HEAT When an elderly acquaintance disappears from a nursing home, Giambone's grandmother asks him to investigate. (R)
(11:30) DONNA REED Jeff and his music group make a record.
NEWSNIGHT UPDATE
LATE NIGHT WITH DAVID LETTERMAN Scheduled: comedienne Elaine Bosler, singer John Phillips. In stereo.
(12) CAROL BURNETT AND FRIENDS Guests: Petula Clark, Tim Conway.
FATHER KNOWS BEST Jim is puzzled when he is awakened in the middle of a strange dream.
NEW COUNTRY
TODAY IN WASHINGTON
HORSE RACING WEEKLY
HBO PHILIP MARLOWE, PRIVATE EYE Marlowe is the prime suspect when a hood he was hired to body-guard is found dead. **□**
(11:35) ROCKFORD FILES
HAWAII FIVE-O McGarrett searches for the supplier of an illegal drug which caused the death of a young girl.
ENTERTAINMENT TONIGHT Interview with actress Lauren Hutton.
12:00 ESPY
(12) INDEPENDENT NEWS
700 CLUB
ADVENTURES OF OZZIE & HARRIET "His Brother's Girl" David becomes attracted to Ricky's girlfriend.
FIRE ON THE MOUNTAIN
ALFRED HITCHCOCK HOUR
V.J. JACKSON
ONE FALSE MOVE
SPORTSLOOK
(SHOW) MOVIE ★★ "Tightrope" (1984, Suspense) Clint Eastwood, Genevieve Bujold.
(12:05) LATE NIGHT WITH DAVID LETTERMAN Scheduled: comedienne Elaine Bosler, singer John Phillips. In stereo.
JIMMY SWAGGART
(12:10) MOVIE ★★ "Deadline" (1980, Suspense) Barry Newman, Bill Kerr.
MOVIE ★★ "The Scarface Mob" (1982, Drama) Robert Stack, Keenan Wynn.
(12:15) MOVIE ★★ "Deadline" (1980, Suspense) Barry Newman, Bill Kerr.
MOVIE ★★ "Deadline" (1980,

- Suspense) Barry Newman, Bill Kerr.
12:30 SPORTS LATENT
NEWS
SECOND TYPE Cerebral palsy victim Beth Shapiro and four handicapped friends are followed as they travel from Bergenfield, N.J., to Washington, D.C., in this look at how the handicapped positively confront and overcome physical and emotional barriers. Bill Cosby narrates.
MOVIE ★★ "Knight Without Armour" (1937, Adventure) Robert Donat, Marlene Dietrich.
DANCIN' USA
SPORTSCENTER
IT WAS OF EDEN I WAS DREAMING Hoop Zoo Caldwell brings to life the turbulent world of revolutionary poet Arthur Rimbaud.
HBO WIMBLEDON TENNIS Highlights of the day's matches.
BENNY HILL
CIN CINEMAX COMEDY EXPERIMENT The comic style of Eric Bogosian is showcased in this spoof on drinking in America.
SHOW MOVIE ★★ "The In-Laws" (1979, Comedy) Alan Arkin, Peter Falk.
HBO MOVIE ★★ "Fletch" (1985, Comedy) Chevy Chase, Joe Don Baker.
ROUTE 66
NEWS OVERNIGHT
COMEDY BREAK
MOVIE ★★ "The Sea Horse" (1951, Drama) Rod Cameron, Adele Mara.
BREAK THRU TO WEIGHT LOSS
EDGE OF NIGHT
PBA BOWLING Ebonite-Flybob Classic, from Seattle. (R)
MAKING MONEY WITH GOVERNMENT LOANS
PILOBUSUS Pilobolus Dance Co. joins the Royal Danish Ballet Company for three innovative works including pieces by Moses Pendleton and Jonathan Wolken, with music by Laurie Anderson and others.
(TMC) MOVIE ★★ "I Want You" (1952, Drama) Dana Andrews, Dorothy McGuire.
1:08 FANTASY ISLAND
PERFECT MATCH
CIN MOVIE ★★ "Parina" (1982, Comedy) Ryan O'Neal, John Hurt.
(12) INDEPENDENT NEWS
EDGE OF NIGHT
IN SEARCH OF Arthur Conan Doyle
NIGHTWATCH
MOVIE ★★ "Carnival Story" (1954, Adventure) Anne Baxter, Steve Cochran.
LARRY KING OVERNIGHT
MOVIE ★★ "The Towering Inferno" (1974, Adventure) Bruce L. Chlen Yuet Ben.
GET RICH WITH REAL ESTATE
THAT GIRL
SUCCESS IS NOT AN ACCIDENT (SHOW) MOVIE "Nutcracker" (1984, Drama) Joan Collins, Carol White.
NEWS
WORLD AT LARGE
GET SMART
MOVIE ★★ "Fighter Attack" (1953, Adventure) Sterling Hayden, Joy Page.
ROOM 222
TODAY IN WASHINGTON
HSPANIC REVIEW

Thursday

HBO RODNEY DANGERFIELD HOSTS THE **YOUNG COMEDIANS SPECIAL**. Aspiring comedians perform at Dangerfield's in New York. **SHOW SOMETIMES I WONDER** After their mother brings home a new baby, two children feel they're unloved nuisances and escape to their grandmother's (Colleen Dewhurst) home. (TMC) MOVIE ★★ "Condemned" (1930, Drama) Ronald Colman, Ann Harding.

2:50 **CIN MOVIE** ★★ "Too Scared To Scream" (1985, Drama) Mike Connors, Anne Archer.

3:00 **CROSSFIRE**
BOB NEUHAART
INSTANT CASH SYSTEMS

BEST OF THE SUPERFEST Performers include Kool & The Gang, Patii Labelle, The Mary Jane Girls and The O'Jays for this concert special taped at the Summit in Houston. Host: Lou Rawls. (R)

AUSTRALIAN RULES FOOTBALL
MAKING MONEY WITH GOVERNMENT LOANS

3:30 **SHOWBIZ TODAY**
BEVERLY HILLBILLIES

3:40 **HBO MOVIE** ★★ "History Of The World -- Part I" (1981, Comedy) Mel Brooks, Madeline Kahn.

3:50 **(SHOW) MOVIE** ★★ "The In-Laws" (1979, Comedy) Alan Arkin, Peter Falk.

4:00 **ADVENTURES OF BLACK BEAUTY**
DAYBREAK

NEWS
JIMMY SWAGGART

GET RICH WITH FORECLOSURE
MOVIE ★★ "Ash Wednesday" (1973, Drama) Elizabeth Taylor, Henry Fonda.

VJ: NINA BLACKWOOD
AEROBICS: BODIES IN MOTION

60 MINUTES TO SUCCESS
SHOW THE HAUNTING OF HARRINGTON HOUSE A schoolgirl returns home for a holiday to find strange things happening at her father's hotel.

4:16 (TMC) MOVIE ★★ "Three Little Words" (1950, Musical) Fred Astaire, Red Skelton.

4:30 **NICK ROCKS: VIDEO TO GO**
BUSINESS MORNING

FUNTIME
FAITH

HONEY, HONEY
NATION'S BUSINESS TODAY

4:35 **CIN MOVIE** ★★ "Hollywood Hot Tubs" (1984, Adult)

Danza to star in NBC movie

Los Angeles Times
 Tony Danza of ABC's "Who's the Boss?" is starting in a TV movie for NBC called "Doing Life." He plays Jerry Rosenberg, a man who earned a law degree in prison and went on to defend other inmates and battle for prisoners' rights while still behind bars.

ATTENTION CABLE SUBSCRIBERS!

Tired of Summar Raruns?
 We'll give you what cable can't, plus
 • 50 FM Radio Stations • More Selections of First Run Movies • Better Picture Quality • The Movie Channels for the Entire Family • Cinemax not available from Cable • Spanish Channels • Home Theatre Network.

Introducing ASC Network!

The one you can't get on cable. No, it isn't scrambled.
 The very best in family programming with over 2800 first line movies.



THE Complete SATELLITE SYSTEM

Receive the same Network programming as the Salt Lake and Boise Channels via Satellite. You can count on us. Just ask our more than 5000 customers!

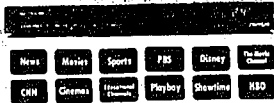

We can give you what cable can't. Each premium channel has 2 different programming schedules. Choose from 2 HBO movies at the same time, or 2 different showtime selections, 2 cinemax stations, 2 movie channels, and on it goes. We can offer you more. Inquire today.

Complete Remote Controlled System



Motor-Driven Rack & Pinion Mount
 For the most trouble-free tracking of the satellites.

- For KU Band satellites
- Built-in travel stops
- Die-cast housing protects the unit from the elements
- High resolution motor drive for precision aiming accuracy
- Low friction pivots with sealed maintenance-free ball bearings

Reg. \$2995 ... **\$1999**

FREE INSTALLATION
 \$98.95 Down, \$59.79 per mo., for 48 mo. on approved credit.

FREE Satellite Descrambler
 Included With System.
 With This Descrambler You Can Legally Receive All Available Satellites.

Bring this coupon to Sound Co. to register for a **FREE satellite system.**

1248 Blue Lakes Blvd. N., Twin Falls 110 E. Main St., Boise

Name _____ Phone _____

Address _____

Check Box If Yes.

Would you like to know more about satellite television?

Would you like to be contacted and given information on satellite television?



THE SOUND COMPANY

1248 BLUE LAKES BLVD. N. TWIN FALLS, IDAHO 83403

1100 WASHINGTON STREET BOISE IDAHO 83725

NBC's 'Liberty' recounts story of making of Statue of Liberty



Frank Langella stars as Frederic Auguste Bartholdi, the man who originally conceived and campaigned for the Statue of Liberty, in the NBC movie 'Liberty'

By JERRY BUCK
The Associated Press

LOS ANGELES — As America prepares to celebrate the Statue of Liberty's 100th birthday following her two-year facelift, NBC takes a look at how the statue came to stand in New York Harbor.

The three-hour movie "Liberty," will be broadcast Monday at 7 p.m. on KBCI-Boise, KID-Idaho Falls, KMVT-Twin Falls and KSL-Salt Lake City.

"Liberty" tells the story behind Liberty Enlightening the World, the statue's proper name, and how it was the culmination of a dream of French sculptor Frederic Auguste Bartholdi.

Frank Langella stars as Bartholdi, Carrie Fisher as poetess Emma Lazarus, Claire Bloom as Bartholdi's mother, Corinne Touzet as his mistress, and George Kennedy, Chris Sarandon and LeVar Burton as fictional workmen who helped erect the statue. Richard Sarafian directed on location in Paris and Baltimore from a screenplay by Pete Hamill.

French historian Edouard de Laboulaye suggested the monument as a gift from the French people to America. "He encouraged Bartholdi and after that it became very much his life," said Langella. "It took him 17 years to accomplish."

Langella describes Bartholdi, who designed the statue and oversaw its construction, as "obsessive, extremely

loyal, determined, from a rather well-to-do background, and somewhat controlled by his mother until he met the woman who became the statue's inspiration." That was Jeanne Baheau, who became first his mistress, then his wife. Still, it was his mother's face that eventually ended up on the statue.

"I like period pieces, but I don't prefer them," said Langella. "I like them because they open you up to certain kinds of language, certain kinds of attitudes and certain characterizations. There are dozens of modern men you can play, but if you do an 18th century character it offers you a crack at something different. And I was trained in the classical theater.

"If I'm going to play a husband of a woman being terrorized by a burglar, I can pretty much tell you what to expect. But if I play a sculptor in the 19th century dominated by his mother, and there are wars and horses, there are so many shadings. The Franco-Prussian War was going during this time he was inspired to create the statue."

He added, "There are few restrictions to playing a historical character. If you play a character the way research tells you, it limits you. But no amount of research can tell you what his mother said to him or what he said to his mistress. So, you do have some liberty."

Langella said Bartholdi visited the United States and personally suggested Bedloe's Island, then overrun by goats, as the site for the statue.

The movie tells both a historic story of Bartholdi and a fictional story involving the coppersmiths who put the statue together from the parts shipped from France. Emma Lazarus, who wrote the poem "The New Colossus," which is inscribed on the base of the statue, is also involved in a fictional relationship with one of the workers.

Prior to "Liberty," Langella completed work on the theatrical film "The Men's Club." It will be released in September.

"That was the first film I ever did in Los Angeles," he said. "I can't believe I've never done a film here before. We shot a week in San Francisco and did the rest here. The picture tells the story of seven men, 35 to 50, all of whom are going through some crisis. Roy Scheider is an ex-athlete who's going through a mid-life crisis. He asks his friends to form a men's club. We talk about our lives until it descends into a drunken brawl.

"There are vignettes of each man's life. It's unique. I don't know of a film that tries to tell seven individual stories. It also stars Richard Jordan, Treat Williams, David Dukes, Craig Wasson, Harvey Keitel, Stockard Channing and Ann Wedgeworth."

Langella, who won a Tony award for "Seascape," is probably best known for his role in "Dracula," which he played both on Broadway and in the movies.

"I remember for the film my first scenes were with Laurence Olivier in Cornwall in England," he said. "They got his closeups, but mine turned out too dark. Three months later, in London, Sir Laurence is off the picture. And I get on a horse in the back of the studio, where they're burning some trash. They put an 8x10 picture of Sir Laurence on a stick and I sat on the horse on the road and talked to the picture."

CBS reclaims top slot for news, but network rating slides to 3rd

By ROBERT BARR
The Associated Press

NEW YORK — "CBS Evening News" and Dan Rather climbed back into first place in the network news race last week without basketball to bounce the schedule around, but the network finished in third place overall.

CBS won the evening news race last week with a 10.3 rating and a 22 share, ahead of NBC with a 9.7 rating and 22 share and ABC with a 9.4 rating and 21 share, according to figures released Tuesday by A.C. Nielsen Co.

"NBC Nightly News" won the race the previous week with a 10.4 rating, edging CBS at 10.1 and ABC at 10.0.

CBS, which had won the news race for 213 consecutive weeks, had preempted Rather in 20 West Coast markets twice during the first week of June to broadcast the National Basketball Association playoffs.

NBC's news division was cheered, however, by a strong showing for the premiere of "1986," the magazine show anchored by Roger Mudd and Connie Chung. It placed 23rd for the week with a rating of 12.3 and a 23 share, which Jaffe said was the best

debut for a show of its type since "Prime Time Saturday" in 1979.

In the last seven weeks, CBS News has a rating of 11.0 and a 23 share, compared with 10.5 for NBC and 9.8 for ABC. Compared with the same period a year ago, NBC's "Nightly News" is up 8 percent in the ratings, ABC is up 5 percent and CBS is off 1 percent, according to Gerald Jaffe, NBC's vice president for research projects.

Each ratings point equals 859,000 homes with television. The share is the percentage of sets in use during the time period.

David Poltrack, CBS' vice president for research, characterized the network's .6 of a point edge in the news ratings as "fairly healthy," and predicted that the lead would grow in the fall when more sets are in use.

Top-rated NBC won the overall race for the week by sweeping the top five positions on the way to a 12.8 rating and a 25 share, followed by ABC with a 10.4 rating and 20 share and CBS with a 9.9 rating and a 19 share.

"The Cosby Show" finished No. 1 with a 25.4 rating and 48 percent of the audience in its time period,

followed by "Family Ties," "Cheers," a special "All Is Forgiven" segment and "Golden Girls," all on NBC.

However, "All Is Forgiven" is looking for a new home. NBC decided not to pick it up despite a successful nine-week run.

Rounding out the top 10 were "Growing Pains," "2020" and "Who's the Boss?" all on ABC, and three shows tied for ninth: "227" on NBC, "Murder, She Wrote" on CBS and "Hardcastle & McCormick" on ABC.

CBS, without its highly rated "Dallas" and "Falcon Crest" serials during the summer, suffered through Friday night with the film "Brotherly Love" starring Judd Hirsch and Karen Carlson, which got a 9.1 rating and 18 percent of the audience.

Poltrack added that CBS was also hurt by juggling its schedule on Tuesday and Wednesday nights, and said it usually takes a week or two for viewers to adjust.

"We would expect the numbers to go up in the next couple of weeks," Poltrack said, "but we recognize that NBC should be able to hold first through the summer."

What's in a name? PBS better find out

The Denver Post

LOS ANGELES — A public TV show by any other name would have a better chance of getting someone to watch it.

The Public Broadcasting Service could take a cue from commercial programmers when it comes to the series name game. A glance at the PBS' premiere titles for fall tells you nothing less—or worse, scares you away from potentially fascinating shows with boring titles.

Quick, what is "Out of the Fiery Furnace"? Is it a documentary about coal and railroads or a hellish allusion to Mount St. Helens? A how-to show about wood stoves or a short-course in ceramics?

Actually, it's a seven-part series about metallurgy, beginning in the fall. If this show were on ABC, the title would be "Hot and Hard" or, at least, "Heavy Metal."

What do you suppose they mean by "The Day the Universe Changed"? Sounds like a bad black-and-white self-movie insinuations might find on an independent station at 1:30

a.m. But no, it's James Burke's new 10-part exploration of, well, everything. The Renaissance, the Industrial Revolution, the rise of modern medicine, theories of evolution — he covers it all rather smugly while walking around the globe. The commercial networks wouldn't consider airing such a thing, let alone naming it.

What about "The Story of English"? Is it about British manners and tea, or a sleep-inducing English 101 course in grammar?

Neither. In fact, this nine-part history of the English language, also scheduled for next fall, may be the most riveting new series on the public TV schedule. If only the name were catchier.

Robert MacNeil brings his Nova Scotia accent to the task of narrating the series, tracking the world's most universal language from an obscure Germanic tribe to current controversies over black English, "Franglais" and "Japlish." Everyone from Moon Zappa (valleyspeak consultant, fer sure) to

New York Times language nit-picker William Safire appears in the introductory hour. A BBC co-production co-written by MacNeil and Robert McCrum, the show will air simultaneously here and in Britain with essentially the same English in each version, minus a few "bell-ringer" pronunciations that would irritate one nation or the other (like the American "clerk" vs. the British "clark").



OVERHEAD DOOR

- SALES
- SERVICE
- INSTALLATION

OVERHEAD DOOR
of S.W. IDAHO
489 South Locust Phone 733-5721
Cell Toll Free: 1-800-228-8536

Synergy between NBC, affiliates (and Tartikoff) boosts ratings

By MORGAN GENDEL
Los Angeles Times

KAANAPALI, Hawaii — Even as NBC developed "The Cosby Show" and dreamed of its climb out of the ratings cellar a few years ago, KYTV-TV, the network's Springfield, Mo., affiliate, was beefing up its "Action News" and widening its ratings lead over that city's ABC and CBS affiliates.

The two events were coincidental, but mutually beneficial. Many viewers of "KY3," as locals call it, kept their dials tuned to NBC's prime-time series, boosting their ratings a bit. In turn, the success of the network's shows added a new layer of muscle to the station's 30-year lock on its No. 1 local position.

A similar story can be told all over the country. Local stations build their reputations and profits one way, the networks another. The common ground provides the basis for a longstanding relationship.

"We need each other," said Bill Moll, co-owner of KYTV. "You provide a lead-in for their prime time; they provide a lead-in for your late news, so the synergy is important."

The president of broadcasting for Harte-Hanks Communications, Moll is among the 30-odd owners of a station group that includes affiliates of each of the three major networks. That is why he is among a few broadcasters who can — and do — attend all three networks' annual affiliate station meetings, such as the one that NBC held here on Maui last week.

Moll offers a keen perspective on the role of the local station: a role that in nearly every community gives it an identity distinct from the network.

The distinction is sufficient to make local winners out of network second-best. Harte-Hanks' two CBS stations — in San Antonio, Texas, where the company is based, and in Greensboro, N.C. — are No. 1 in their local markets, thanks largely to strong news operations.

"There are two things that distinguish you in a market," Moll said. "One is your network; the other is your local news. Go into any market — go into Springfield, Mo. — and say 'Tell me about "KY3," and they'd say 'Action News.'"

While the network provides about 75 percent of an affiliate station's programming (the remaining 25 percent defines the station's identity

and generates most of its revenue. Moll said that almost half the station revenues at his company's NBC and CBS stations are generated by news shows.

But Moll's ABC station, WTLV-TV in Jacksonville, Fla., would be earning \$1.5 million to \$2 million a year more, Moll estimated, if it were affiliated with NBC, as it once was. That represents about 12 percent of annual revenues.

Thus, "The Cosby Show" is worth more to any NBC affiliate than the couple thousand dollars a week the network pays local stations to air the show.

Such is the power of a strong network lineup.

That is why the NBC affiliates came in off the golf courses and beaches in droves to the final business session last week to hear programming chief Brandon Tartikoff give a night-by-night analysis of the fall prime-time schedule.

(It's also why the affiliates were so delighted to hear that Tartikoff signed a new contract with the network to remain as president of the entertainment division. "Brandon, right now, is the best programmer in television," James Lynch, chairman of the NBC affiliates board of directors, said.)

Too, it caused NBC affiliates to sound a note of concern about what they perceive as weak programming from 10 p.m. to 11 p.m. in the fall. NBC's move to pit "Miami Vice" against CBS' "Dallas" Fridays at 9 may give the network another night in its victory column, but if the number of viewers drops when the unproven "L.A. Law" comes on at 10 p.m., the affiliates can get hurt.

The word that frightens the network is pre-emption.

"If a show is doing poorly in prime time, perhaps I can do better by replacing it with an off-network show (a rerun of a former series), a movie or a local event," Moll explained. Why carry "Sports World," the theory goes, if airing Kansas City Royals baseball in the Springfield market will bring higher ratings?

"ABC is going through that right now" in prime time, Moll noted.

Moll participated in a worst-case scenario for a third-place network: defection. In 1980, Harte-Hanks switched WTLV's affiliation from NBC, then in third place, to ABC, which was coming off a prime-time winning streak in the late '70s.

"It was a short-term help," Moll

said, "and it's not helping us now."

The delicate balance of power between network and affiliate has since tipped to NBC's favor; the network now must decide whether to stick with the NBC affiliate that saw it through its rise to the top — or to bestow its affiliation upon a possibly stronger operation, such as Moll's.

"We've had ongoing dialogues with the network for five years, since we left," Moll said. The return of WTLV to the NBC fold, he said, "is an open question."

If the network-affiliate relationship is one of equal partners, the local broadcaster still has a master: the local community.

"I don't want to get maudlin about it, but part of the culture we operate in as broadcasters is community service," Moll said. "Most of the people in that room were attracted to this business because they had some other kind of need or motivation. ... You can actually do something for the community."

Local news shows initially were mandated by the Federal Communications Commission. Moll said that the recent easing of federal standards has had little or no effect on station owners' self-imposed standards.

"The better community servant you are, the better your business is," he said.

Business happens to be "outstanding" now for network-affiliated commercial broadcasters, Moll said. "But it's softer than it's been. Part of that has to do with the competitive environment. There are a great many more players out there."

That situation, combined with the current squeeze on profit margins, has made ABC's frugal new executives from Capital Cities Communications (the broadcast group that this year merged with ABC Inc.) as successful at fiscal management as NBC is at programming.

"I've always admired Cap Cities' frugality," Moll said. "Everyone's containing costs, and it's just program costs. We've always tried to balance that with giving it back to the community."

TV puzzle

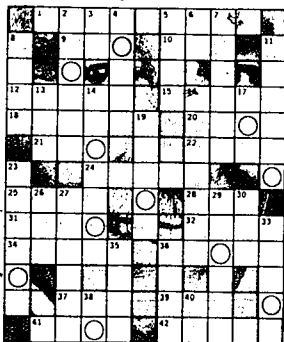

ACROSS

- 1 Amer. Information Agcy.
- 5 Elliott and Bottoms
- 9 He's George Utley
- 10 Flower garland
- 12 Bumps
- 15 Chief on "Get Smart"
- 18 "The — of Night"
- 20 Anatomy: abbr.
- 21 Comparative ending
- 22 Joint
- 24 Edit
- 25 He's Jason Seavers
- 28 Cantor or Lupino
- 31 "Mod Squad" character
- 32 Tidings
- 34 Apple —
- 36 "Secret —"
- 37 Harvest goddess
- 39 Energy off.
- 41 "The Bold —"
- 42 Murray or Bancroft

DOWN

- 2 Curly or Moe
- 3 Input/output: abbr.
- 4 He was James Evans
- 5 Mistake
- 6 Monogram for Elson
- 7 Samantha on "Who's the Boss?"
- 8 Actor Farrell
- 11 Jack on "Three's a Crowd"
- 13 No data available: abbr.
- 14 Stamp or Knox
- 16 Alighting
- 17 Little
- 19 Inaligna (clue to puzzle answer)
- 23 Hawk (clue to puzzle answer)
- 25 Roman 52
- 27 "Sanford —"
- 29 Eddie on "Punky Brewster"
- 30 Grass part
- 33 Headliner
- 35 Shavar or Ted
- 36 He was Hawkeyes
- 38 Hebrew letter
- 40 "— Golden Pond"

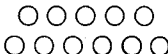

NBC study: VCRs spur network viewing

Los Angeles Times

LOS ANGELES — Videocassette recorders, the culprits accused of luring customers away from movie theaters and pay-cable services, actually benefit network television, an NBC researcher said Monday.

"VCRs provide us with viewers who would have otherwise been unavailable to commercial television," Bill Rubens, NBC vice president for research, told a gathering of the nation's TV critics at the Century Plaza hotel here.

Rapid growth in VCR ownership could affect everything from the quality of commercial spots to future prime-time battles like the one coming next season between CBS' "Dallas" and NBC's "Miami Vice."

Though VCR use currently makes little more than a blip on the Nielsen ratings charts, recorders now are in one third of all American homes with TV.

Some highlights of NBC's research:

— The most-recorded TV show is the "CBS Sunday Movie," which on average is videotaped by about 530,000 of the 85.9 million TV homes. NBC's and ABC's weekly movie offerings also are among the 10 most-recorded prime-time shows.

— The entire NBC Thursday night lineup, from "The Cosby Show" through "Hill Street Blues," is recorded in about 350,000 homes. The only other weekly series on the top-10 list is CBS' "Dallas."

— Network TV shows account for nearly three-fourths of all home recording use. Video recording increases the audience of a prime-time network show by two-tenths of a ratings point, on average. (One ratings point is 1 percent of all television homes, or about 859,000.)

— The typical VCR owner plays back two to three hours of home recordings per week, compared with one to two hours of rented movie cassettes.

— Daytime game shows are not recorded in any measurable amount, "as you might expect," Rubens said.

But soap operas on average attract two-tenths of a ratings point.

— News, sports and late-night shows are practically never recorded, surveys by the Nielsen ratings service show.

answer



CESAR
ROMERO

To Turn A Life Around

Walker
ACT
Center
Gooding, ID

Inpatient treatment
for alcoholism and
chemical dependency
throughout Southern
Idaho

Covered by most insurance plans

Information/Referral/Family Interventions

Call toll-free
1-800-227-4190
or 734-4200

B Affiliated with St. Benedict's Health System, Ogden, Utah